

Gahcho Kué Project

2014 Feasibility Study

NI 43-101 Technical Report

May 13, 2014 as Amended May 27, 2014
EFFECTIVE DATE: MARCH 31, 2014



Qualified Persons

Daniel D. Johnson, P. Eng.

Kenneth Meikle, P. Eng.

Dino Pilotto, P. Eng.

Kato Lone, Eng.

Date & Signature Page

Project Name: **Gahcho Kué Project**
Title of Report: Gahcho Kué Project 2014 Feasibility Study
NI 43-101 Technical Report
Effective Date of Report: March 31, 2014
Completion Date of Report: May 13, 2014 as Amended May 27, 2014

----- ORIGINALS SIGNED -----

---- SEAL ----

----- Date -----

"Daniel D. Johnson," P. Eng.
(JDS Energy & Mining, Inc.)

May 27, 2014

"Kenneth Meikle," P. Eng.
(JDS Energy & Mining, Inc.)

May 27, 2014

"Dino Pilotto," P. Eng.
(JDS Energy & Mining, Inc.)

May 27, 2014

"Kato Lone," Eng.
(Hatch Ltd.)

May 27, 2014



CERTIFICATE of QUALIFIED PERSON

Daniel Johnson, P. Eng.

I, Daniel Johnson, P. Eng., do hereby certify that:

- 1) I am a Principal of JDS Energy & Mining Inc. with an office at Suite 200 - 532 Leon Ave., Kelowna, BC, V1Y 6J6, Canada.
- 2) This certificate applies to the technical report (Report) entitled: "Gahcho Kué Project; 2014 Feasibility Study; NI 43-101 Technical Report", as Amended May 27, 2014 with effective date March 31, 2014.
- 3) I am a Registered Professional Mining Engineer in good standing in NWT/Nunavut and in Virginia, USA (#0402038687). I am a graduate of Virginia Tech with a Bachelor of Science degree in Civil Engineering, 1977. I am a graduate of the Amos Tuck School of Business Administration at Dartmouth College with a Masters of Business Administration, 1981. I have practiced my profession continuously since 1981. Relevant experience includes advanced exploration, mine design, permitting, engineering and construction, operations management, and executive management for mineral related properties, mines and companies.
- 4) I have completed personal inspections of the Gahcho Kué Project site on September 18, 2007; August 1, 2013; February 15, 2014 and April 15, 2014.
- 5) I am responsible for Items (Sections) 1 to 12, 14, 21.1.2, 21.1.3, 23, 24.2, 24.3, 24.4 and 25 to 27 of this technical report entitled "Gahcho Kué Project; 2014 Feasibility Study; NI 43-101 Technical Report", as Amended May 27, 2014 with effective date March 31, 2014.
- 6) I am independent of the issuer, Mountain Province Diamonds Inc., as defined in Section 1.5 of NI 43-101.
- 7) I have prior involvement with the Gahcho Kué property since 2007 and was an author of some sections in the report entitled "Gahcho Kué Project, Definitive Feasibility Study, NI 43-101 Technical Report", with effective date October 15, 2010.
- 8) I have read the definition of "Qualified Person" set out in NI 43-101 and certify that by reason of my education, affiliation with a professional association, and past relevant experience, I fulfill the requirements to be a "qualified person" for the purposes of NI 43-101.
- 9) I have read NI 43-101 and confirm that the sections of the Report for which I am responsible, have been prepared in compliance of NI 43-101.
- 10) As of the effective date of the Report, to the best of my knowledge, information and belief, this technical report contains all scientific and technical information that is required to be disclosed to make the technical report not misleading.

"Signed & Sealed May 27, 2014"

Daniel D Johnson, P.Eng
Principal, JDS Energy & Mining Inc.



CERTIFICATE of QUALIFIED PERSON

Kenneth Meikle, P. Eng.

I, Kenneth Meikle, P. Eng., do hereby certify that:

- 1) I am a Mining Engineer on contract with JDS Energy & Mining Inc. with an office at Suite 200 - 532 Leon Ave., Kelowna, BC, V1Y 6J6, Canada.
- 2) This certificate applies to the technical report (Report) entitled: "Gahcho Kué Project; 2014 Feasibility Study; NI 43-101 Technical Report", as Amended May 27, 2014 with effective date March 31, 2014.
- 3) I am a Registered Professional Mining Engineer in good standing in Ontario (#100074134) and British Columbia (#17534). I am a graduate of Montana Tech with a Bachelor of Science degree in Mining Engineering, 1985. I have practiced my profession continuously since 1985. Relevant experience includes mine planning, operational costing, and economic evaluations on both operating and pre-development open pit diamond, copper, molybdenum, and gold properties.
- 4) I have read the definition of "Qualified Person" set out in NI 43-101 and certify that by reason of my education, affiliation with a professional association, and past relevant experience, I fulfill the requirements to be a "qualified person" for the purposes of NI 43-101.
- 5) I completed a personal inspection of the Gahcho Kué Project site on June 25-26, 2012.
- 6) I am responsible for Items (Sections) 19, 21.2 and 22 of this technical report entitled: "Gahcho Kué Project; 2014 Feasibility Study; NI 43-101 Technical Report", as Amended May 27, 2014 with effective date March 31, 2014.
- 7) I am independent of the issuer, Mountain Province Diamonds Inc., as defined in Section 1.5 of NI 43-101.
- 8) I have prior involvement with the Gahcho Kué property and was an author of some sections in the report entitled "Gahcho Kué Project, Definitive Feasibility Study, NI 43-101 Technical Report", with effective date October 15, 2010.
- 9) I have read NI 43-101 and confirm that the sections of the Report for which I am responsible, have been prepared in compliance of NI 43-101.
- 10) As of the effective date of the Report, to the best of my knowledge, information and belief, this technical report contains all scientific and technical information that is required to be disclosed to make the technical report not misleading.

"Signed & Sealed May 27, 2014"

Kenneth Meikle, P.Eng
Principal Mine Engineer, JDS Energy & Mining Inc.



CERTIFICATE of QUALIFIED PERSON

Dino Pilotto, P.Eng.

I, Dino Pilotto, P. Eng., do hereby certify that:

- 1) I am a Senior Engineer of JDS Energy & Mining Inc. with an office at Suite 860 - 625 Howe Street, Vancouver, BC, V6C 2T6, Canada.
- 2) This certificate applies to the technical report (Report) entitled "Gahcho Kué Project; 2014 Feasibility Study; NI 43-101 Technical Report", as Amended May 27, 2014 with effective date March 31, 2014.
- 3) I am a Registered Professional Mining Engineer in good standing in the Northwest Territories, Alberta and Saskatchewan. I am a graduate of the University of British Columbia with a B.Sc. in Mining and Mineral Process Engineering (1987). I have practiced my profession continuously since June 1987. Relevant experience includes mining operations, mine engineering and consulting covering a variety of commodities at locations in North America, South America, Africa, and Eastern Europe.
- 4) I have not visited the Gahcho Kué Project site.
- 5) I am responsible for Items (Sections) 15 and 16 of this technical report entitled "Gahcho Kué Project; 2014 Feasibility Study; NI 43-101 Technical Report", as Amended May 27, 2014 with effective date March 31, 2014.
- 6) I am independent of the issuer, Mountain Province Diamonds Inc., as defined in Section 1.5 of NI 43-101.
- 7) I have had prior involvement with the Gahcho Kué property since 2008 and assisted with some sections in the report entitled "Gahcho Kué Project, Definitive Feasibility Study, NI 43-101 Technical Report," with effective date October 15, 2010.
- 8) I have read the definition of "Qualified Person" set out in NI 43-101 and certify that by reason of my education, affiliation with a professional association, and past relevant experience, I fulfill the requirements to be a "qualified person" for the purposes of NI 43-101.
- 9) I have read NI 43-101 and confirm that the sections of the Report for which I am responsible, have been prepared in compliance of NI 43-101.
- 10) As of the effective date of the Report, to the best of my knowledge, information and belief, this technical report contains all scientific and technical information that is required to be disclosed to make the technical report not misleading.

"Signed & Sealed May 27, 2014"

Dino G Pilotto, P.Eng
Senior Engineer, JDS Energy & Mining Inc.

CERTIFICATE of QUALIFIED PERSON**Kato Lone, Eng.**

I, Kato Lone, Eng., do hereby certify that:

- 1) I am a Project Manager with Hatch with an office at 5 Place Ville Marie, suite 200, Montreal, Quebec H3B 2G2, Canada.
- 2) This certificate applies to the technical report (Report) entitled: "Gahcho Kué Project; 2014 Feasibility Study; NI 43-101 Technical Report", as Amended May 27, 2014 with effective date March 31, 2014.
- 3) I am a Registered Engineer in good standing in Quebec (#124769). I am a graduate of NTH (Norwegian Institute of Technology, presently NTNU) with a Masters of Science degree in Mechanical Engineering, 1984. I have practiced my profession continuously since 1984. Relevant experience includes project management in the oil and gas industry, mechanical engineering and mechanical completion of a magnesium project as well as management of studies in the TiO₂ industry.
- 4) I completed a personal inspection of the Gahcho Kué Project site on August 1st, 2013.
- 5) I am responsible for Items (Sections) 13, 17, 18, 20, 21.1, 21.1.1, 24.1, 24.5, 24.6 of this technical report entitled: "Gahcho Kué Project; 2014 Feasibility Study; NI 43-101 Technical Report", as Amended May 27, 2014 with effective date March 31, 2014.
- 6) I am independent of the issuer, Mountain Province Diamonds Inc., as defined in Section 1.5 of NI 43-101.
- 7) I have no prior involvement with the Gahcho Kué property.
- 8) I have read the definition of "Qualified Person" set out in NI 43-101 and certify that by reason of my education, affiliation with a professional association, and past relevant experience, I fulfill the requirements to be a "qualified person" for the purposes of NI 43-101.
- 9) I have read NI 43-101 and confirm that the sections of the Report for which I am responsible, have been prepared in compliance of NI 43-101.
- 10) As of the effective date of the Report, to the best of my knowledge, information and belief, this technical report contain all scientific and technical information that is required to be disclosed to make the technical report not misleading.

"Signed & Sealed May 27, 2014"

Kato Lone, Eng.
Project Manager, Hatch Ltd.

Table of Contents

SECTION 1 SUMMARY	1
1.1 Property Description & Ownership	1
1.2 Geology, Resources & Reserves	5
1.3 Mining	6
1.4 Recovery Methods	7
1.5 Site & Infrastructure	7
1.6 Environmental & Socioeconomic	9
1.7 Project Execution	10
1.8 Capital Cost Estimate	11
1.9 Operating Cost Estimate	12
1.10 Financial Analysis.....	13
1.11 Conclusions.....	13
1.12 Recommendations	14
SECTION 2 INTRODUCTION	15
2.1 Report Preparation.....	15
2.2 Qualifications & Responsibilities.....	16
2.3 Site Visits	17
2.4 Currency	17
2.5 Units of Measure & Abbreviations.....	17
SECTION 3 RELIANCE ON OTHER EXPERTS	19
3.1 Mineral Tenure.....	19
3.2 Diamond Valuations.....	19
3.3 Other Information Sources.....	20
SECTION 4 PROPERTY DESCRIPTION & LOCATION.....	21
4.1 Location.....	21
4.2 Tenure History.....	22
4.3 Mineral Tenure.....	22
4.4 Agreements.....	23
4.5 Surface Rights.....	26
4.6 Permits	28
4.7 Environment.....	28
SECTION 5 ACCESSIBILITY, CLIMATE, LOCAL RESOURCES, INFRASTRUCTURE & PHYSIOGRAPHY	32
5.1 Site Access.....	32
5.2 Climate	32
5.3 Local Resources & Infrastructure	33
5.4 Physiography	34

SECTION 6 HISTORY	35
6.1 Historical Timeline	35
6.2 Historical Mineral Resource Estimations	36
SECTION 7 GEOLOGICAL SETTING & MINERALIZATION	37
7.1 Geological Setting	37
7.2 Mineralization	54
SECTION 8 DEPOSIT TYPES	60
SECTION 9 EXPLORATION	62
9.1 Survey	62
9.2 Geological Mapping	63
9.3 Exploration Programs	63
9.4 Delineation Programs	64
9.5 Petrography, Mineralogy & Other Studies	65
9.6 Hydrology & Geotechnical	65
9.7 Comment	66
SECTION 10 DRILLING	67
10.1 5034	67
10.2 Hearne	68
10.3 Tuzo	68
SECTION 11 SAMPLE PREPARATION, ANALYSES, & SECURITY	70
11.1 Core Sample Preparation	70
11.2 Mini Bulk Sample Preparation	71
11.3 Analyses	72
11.4 Mini-Bulk Samples	75
11.5 Program Quality Assurance/Quality Control	77
11.6 Database	80
11.7 Sample Security	81
SECTION 12 DATA VERIFICATION	83
SECTION 13 MINERAL PROCESSING & METALLURGICAL TESTING	84
13.1 Metallurgical Testwork	84
13.2 Process Plant Design	88
SECTION 14 MINERAL RESOURCE ESTIMATES	89
14.1 Introduction	89
14.2 Mineral Resource Estimation	90
14.3 Mineral Resource Classification	120
14.4 Mineral Resource Summary	124

SECTION 15 MINERAL RESERVE ESTIMATES.....	126
15.1 Use of Pit Shells to Evaluate the Mineral Reserve	127
15.2 Open Pit Optimization	129
15.3 Dilution	130
15.4 Open Pit Mineral Reserves	131
SECTION 16 MINING METHODS	133
16.1 Introduction.....	133
16.2 Mine Planning & Design Criteria	133
16.3 Pit Optimization.....	133
16.4 Pit Design.....	134
16.5 Mine Production Plan.....	139
16.6 Mine Equipment.....	142
16.7 Explosives	145
16.8 Mine Personnel	145
SECTION 17 RECOVERY METHODS.....	147
17.1 Process Summary	147
17.2 Process Description	148
17.3 Process Design Criteria & Quality.....	161
17.4 Plant Control Philosophy.....	161
17.5 Process Plant Facilities Description	162
SECTION 18 PROJECT INFRASTRUCTURE.....	163
18.1 Introduction.....	163
18.2 Site Layout.....	164
18.3 Power Distribution	167
18.4 Fuel Supply, Storage & Distribution	167
18.5 Camp & Administration Office Complex	167
18.6 Truck Shop & Warehouse Facilities.....	168
18.7 Ancillary Facilities	168
18.8 Aerodrome	169
18.9 Roads.....	169
18.10 Fire Protection System	170
SECTION 19 MARKET STUDIES & CONTRACTS.....	171
19.1 Diamond Pricing and Market Studies.....	171
19.2 Contracts	174
SECTION 20 ENVIRONMENTAL STUDIES, PERMITTING, & SOCIAL OR COMMUNITY IMPACT.....	176
20.1 Environmental Impact Review Process	176
20.2 Biophysical Environment.....	179
20.3 Project-Environment Mitigation, Monitoring Programs & Management Plans	199

20.4	Socioeconomic Agreement with GNWT.....	211
SECTION 21 CAPITAL & OPERATING COSTS.....		213
21.1	Capital Cost Estimate	213
21.2	Operating Cost Estimate	220
SECTION 22 ECONOMIC ANALYSIS		235
22.1	Summary	235
22.2	Assumptions & Evaluation Methodology.....	236
22.3	Sunk Costs	239
22.4	Revenue.....	239
22.5	Total Construction Capital Estimate.....	241
22.6	Operating Costs	243
22.7	Fiscal Parameters & Taxes.....	244
22.8	Net Present Value Summary	245
22.9	Sensitivity	246
22.10	Scenario Performance	249
22.11	Payback.....	254
22.12	Mine Life.....	254
SECTION 23 ADJACENT PROPERTIES.....		255
SECTION 24 OTHER RELEVANT DATA & INFORMATION.....		256
24.1	Project Execution.....	256
24.2	Water Management & Hydrology.....	260
24.3	Mineral Waste Management	263
24.4	Mine Closure	265
24.5	Operational Readiness	267
24.6	Risk Management.....	268
SECTION 25 INTERPRETATION & CONCLUSIONS		271
25.1	Interpretation.....	271
25.2	Cautions Regarding Forward-Looking Information.....	272
25.3	Conclusions.....	272
SECTION 26 RECOMMENDATIONS		276
SECTION 27 REFERENCES		277

List of Tables

1.1	Mineral Resource Summary (March 31, 2014)	5
1.2	Mineral Reserve Estimate	6
1.3	Key Period Milestones.....	11
1.4	Capital Cost Estimate by WBS	12
1.5	Operating Cost Estimate Summary	13
2.1	Gahcho Kué NI 43-101 Author Responsibility	16
2.2	Units of Measure & Abbreviations.....	17
4.1	Mineral Tenure Summary	25
4.2	Major Regulatory Permits, Licences & Authorizations Required for Gahcho Kué.....	29
7.1	Characteristics of Gahcho Kué Kimberlites	45
13.1	Mineralization Characteristics 2000 (Summary).....	84
13.2	Mineralization Characteristics 2001 & 2002 (Summary)	85
13.3	Diamond Recovery Characteristics (Evaluation Programs).....	85
13.4	Testwork Summary.....	86
14.1	5034 West & Centre Raw LDD Data	92
14.2	Raw Sample Data Statistics	92
14.3	5034 Composite Statistics by Rock Type	94
14.4	Comparing Kriged & NN Estimates by Rock Type	94
14.5	Calculated Dry Density by Rock Type	95
14.6	Core Holes for Macro-diamonds from 5034 North & East Lobes	97
14.7	5034 North & East Lobe Micro-diamond Sampling Results per Litho-facies	97
14.8	Zonal Diamond Content for 5034 North-East Lobe.....	99
14.9	Estimated Zonal Grades for Gahcho Kué 5034 North & East Lobes	100
14.10	Sampled & Estimated Dry Density for Gahcho Kué 5034 North & East Lobes	101
14.11	Hearne Raw LDDH Data.....	102
14.12	Hearne Composite Statistics by Rock Type	102
14.13	Hearne Kriged & NN Estimate Comparison by Rock Type	104
14.14	Hearne Kriged & NN Estimate Comparison by Rock Group	104
14.15	Tuzo Micro-diamond Recoveries.....	107
14.16	Tuzo Results from GKJV LDD Sampling Carried Out in 1999 & 2008	108
14.17	Results from GKJV Micro-Diamond Sampling	110
14.18	Tuzo Zonal Grade Comparison	111
14.19	Tuzo Sampled & Kriged Kimberlite Dry Density per Lithofacies	113
14.20	Summary of Microdiamond Data Used to Model Average Domain Grades in Tuzo Deep	114
14.21	2008 LDD Data Grouped by Assigned Rock Type	115
14.22	Average Dilution Estimates for 2007 Microdiamond Samples as Generated from Sample Line Scan Measurements.....	116
14.23	Modelled Average Grades for Tuzo Deep Geological Domains	116
14.24	Final Diamond Size Distributions for 5034 West Lobe, 5034 Centre Lobe & Hearne Pipe	118
14.25	Final Diamond Size Distribution for 5034 North-East Lobe	119
14.26	Final Diamond Size Distribution for Tuzo Pipe	120
14.27	Qualitative Levels of Confidence in the Mineral Resource Estimate	120
14.28	Mineral Resource Summary	125
15.1	Whittle® Input Parameters.....	127

15.2	Ultimate Pit Optimization Results	131
15.3	Mineral Reserve Estimate (March 31, 2014).....	132
16.1	Final Optimization Results Used for basis of Ultimate Pit Detailed Pit Design	134
16.2	Comparison of Optimised Whittle Shells & Pit Designs	135
16.3	Gahcho Kué Mine Production Plan	140
16.4	Major Mining Equipment Fleet	143
16.5	WBS 1210 - Mine Operations Personnel.....	145
16.6	WBS 1210 - Mine Maintenance Personnel	145
16.7	Site Services Personnel.....	146
16.8	Technical Services Personnel	146
17.1	High Level Mass Balance - Yearly	149
17.2	Design Criteria	161
19.1	Summary of WWW February 2014 Diamond Prices	173
19.2	Summary of Diamond PricesUsed in Economic Analysis	173
21.1	Capital Cost Estimate by WBS	216
21.2	Capital Cost Estimate by Commodity	216
21.3	Summary of Sustaining Capital Costs, by Year	217
21.4	Summary of Mine Reclamation & Closure Costs.....	219
21.5	Operating Cost Estimate Summary	221
21.6	Summary of Operating Costs, by Year.....	222
21.7	Key Operating Cost Drivers	224
21.8	Mining Operating Cost Summary, by Area.....	226
21.9	Mining Operating Cost Summary, by Cost Package	226
21.10	Process Plant Operating Cost Summary	228
21.11	Power Plant Operating Cost Summary.....	229
21.12	Freight Operating Cost Summary	230
21.13	Freight Operating Cost Summary.....	232
21.14	G&A – Allocation of Annual Operating Costs.....	233
22.1	Financial Model Inputs & Results	236
22.2	Basis for Five-year CPI	238
22.3	WWW Valuation (2014)	240
22.4	Diamond Value by Pit	241
22.5	Capital & Ramp-up Expenditure Cash Flow.....	242
22.6	LOM Capital	243
22.7	Operating Costs by Area over Life of Mine – Reserve Case	243
22.8	Net Present Value Summary (Sunk Costs Excluded)	245
22.9	Net Present Value Summary (Sunk Costs Included).....	246
22.10	Net Present Value for Various Discount Rates.....	246
22.11	Exchange Rate Impact on %IRR.....	248
22.12	LOM Annual Production Schedule and Costs (Excluding Sunk Costs).....	252
22.13	LOM Annual Cashflow (Excluding Sunk Costs)	253
24.1	Key Period Milestones.....	258
24.2	Mine Rock Disposal Locations & Yearly Quantities Placed	263
24.3	Fine PK Management Plan	264
24.4	Coarse PK Management Plan	265

List of Figures

1-1	Location of Gahcho Kué	2
1-2	Mineral Lease Boundary Map	3
1-3	Permit Lease Boundary	4
4-1	Location of Gahcho Kué	21
7-1	Regional Setting, Gahcho Kué Kimberlite Cluster	38
7-2	Litho-structural Interpretation of the Gahcho Kué Area.....	40
7-3	3D View of Gahcho Kué Kimberlite Bodies Looking Northwest.....	46
7-4	Section View of Hearne Looking Northwest	46
7-5	3D View of 5034 Looking Northwest.....	47
7-6	Profile of 3D Geological Pipe Shell Models from 2009 (left) & 2013 (right)	50
7-7	3D Geological Domain Models	53
7-8	Hearne Kimberlite	54
7-9	5034 Kimberlite	56
7-10	Tuzo Kimberlite	57
8-1	Composite Geological Model of Eroded Gahcho Kué Kimberlites.....	61
11-1	Generic Micro-Diamond Recovery Flow Sheet	73
15-1	Hearne Whittle Results	128
15-2	5034/Tuzo Whittle Results	128
15-3	Perspective of Whittle Pit-Shell Used for Mineral Reserve Estimate.....	129
16-1	5034 Pit Design.....	136
16-2	Hearne Pit Design	137
16-3	Tuzo Pit design	138
16-4	Annual Tonnes Mined & Grade	140
16-5	Tonnes Mined by Pit & Mined Carats	141
17-1	High Level BFD of the Overall Process/Site	147
17-2	High Level BFD – Gahcho Kué Project	149
17-3	High Level BFD – Area 3100 – Primary Ore Handling.....	151
17-4	High Level BFD – Area 3200 – Feed Preparation.....	152
17-5	High Level BFD – Area 3311 – Dense Medium Separation (Coarse)	154
17-6	High Level BFD – Area 3321 – Dense Medium Separation (Fine)	154
17-7	High Level BFD – Area 3400 – Recovery Plant.....	157
17-8	High Level BFD – Area 3500 – Thickening Area.....	159
17-9	High Level BFD – Area 3600 – Utilities Area.....	160
18-1	Overall Site Plan	165
18-2	Plant Site Layout.....	166
20-1	Aquatic Local Study Area.....	181
20-2	Wildlife Study Area Boundaries.....	182
21-1	Summary of Operating Costs by Year.....	223
21-2	Summary of Unit Operating Costs by Year.....	223
21-3	Key Operating Cost Drivers	224
21-4	Mining Unit Operating Costs, by Cost Package	227
21-5	Process Plant Unit Operating Costs.....	228
21-6	Power Plant Unit Operating Costs.....	229
21-7	Freight Unit Operating Costs.....	230

21-8	G&A Unit Operating Costs.....	232
22-1	Tax Sharing	245
22-2	IRR Variation 3.0 Mt/a Case (sunk costs excluded).....	247
22-3	NPV Variation 3.0 Mt/a Case (sunk costs excluded)	247
22-4	IRR Variation 3.0 Mt/a Case (sunk costs included)	248
22-5	NPV Variation 3.0 Mt/a Case (sunk costs included).....	248
22-6	Annual Cash Flow (C\$ M De-escalated) – Excluding Sunk.....	249
22-7	Cumulative Annual Cash Flow (C\$ M De-escalated) – Excluding Sunk	250
22-8	Annual Cash Flow (C\$ M De-escalated) – Including Sunk	251
22-9	Cumulative Annual Cash Flow (C\$ M De-escalated) – Including Sunk	251
24-1	Pre-disturbance Site Plan	261
24-2	Top 20 Risk Dashboard.....	269

IMPORTANT NOTICE

This Technical Report was prepared as a National Instrument 43-101 Technical Report for Mountain Province Diamonds Inc. (MPV) by Hatch Ltd (Hatch) and JDS Mining & Energy Inc (JDS) and is a summary of the Gahcho Kué Project 2014 Feasibility Study Report. This Technical Report was authored by the Qualified Persons (each a “QP and collectively, the “QPs”) listed in Table 2.1). Each QP assumes responsibility for those sections or areas of this Technical Report that are referenced opposite their name in Table 2.1. None of the QPs employed by Hatch, however, accepts any responsibility or liability for the sections or areas of this Technical Report that were prepared by other non-Hatch QPs.

The quality of information, conclusions, and estimates contained herein is consistent with the level of effort involved in providing the services, based upon: (i) information available at the time of preparation, (ii) data supplied by outside sources, and (iii) the assumptions, conditions and qualifications set forth in this Technical Report. This Technical Report is intended to be used by Mountain Province Diamonds Inc. subject to the terms and conditions of its agreements with each of Hatch and JDS. These agreements permit Mountain Province Diamonds Inc to file this report as this Technical Report with Canadian Securities Regulatory Authorities pursuant to provincial securities legislation. Except for the purposes legislated under provincial securities laws, (a) any other use of this Technical Report by any third party is at that party’s sole risk, (b) the Hatch QP, nor Hatch, shall have any liability to any third party for any such use for any reason whatsoever, including negligence, and (c) each of the contributors hereby disclaims responsibility for any indirect or consequential loss arising from any use of this Technical Report or the information contained herein. This Technical Report is intended to be read as a whole, and sections should not be read or relied upon out of context.

As permitted by Item 3 of Form 43-101F1 – Technical Report, published by the Canadian Securities Administrators (“Form 43-101F1”), the QPs have, in the preparation of this Technical Report, relied upon certain reports, opinions and statements of certain experts. These reports, opinions and statements, the makers of each such report, opinion or statement and the extent of reliance is described in Section 3 of this report. The Hatch QP hereby disclaims liability for such reports, opinions and statement to the extent that they have been relied upon in the preparation of this Technical Report, as described in Section 3.

This Technical Report contains estimates, projections and conclusions that are forward-looking information within the meaning of applicable securities laws. Forward-looking statements are based upon the responsible QP's opinion at the time that they are made but in most cases involve significant risk and uncertainty. Although each of the responsible QPs has attempted to identify factors that could cause actual events or results to differ materially from those described in this report, there may be other factors that cause events or results to not be as anticipated, estimated or projected. There can be no assurance that forward-looking information in this Report will prove to be accurate, as actual results and future events could differ materially from those anticipated in such statements or information. Accordingly, readers should not place undue reliance on forward-looking information. Forward-looking information is made as of the effective date of this Technical Report, and none of the QPs assume any obligation to update or revise it to reflect new events or circumstances, unless otherwise required under applicable laws.

SECTION 1 SUMMARY

This **Gahcho Kué Project 2014 Feasibility Study N.I. 43-101 Technical Report** was prepared for Mountain Province Diamonds Inc. (MPV).

1.1 Property Description & Ownership

The Gahcho Kué (GK) project is a joint venture of De Beers Canada Inc. (DBCI) and Mountain Province Diamonds Inc. (MPV), with ownerships of 51% and 49%, respectively. The property is located in the Northwest Territories (NWT) of Canada, in the District of Mackenzie, 300 km east-northeast of Yellowknife and 80 km east-southeast of the existing Snap Lake Mine (operated by DBCI). The site lies on the edge of the continuous permafrost zone in an area known as the barren lands. The surface is characterised as heath/tundra, with occasional knolls, bedrock outcrops, and localised surface depressions interspersed with lakes. A thin discontinuous cover of organic and mineral soil overlies primarily bedrock, which, occurs typically within a few metres of surface. Some small stands of stunted spruce are found in the area. There are myriad lakes in the area. Kennady Lake, under which the kimberlite pipes lie, is a local headwater lake with a minimal catchment area.

Access to the site is by floatplane in the summer and by aircraft equipped with skis or wheels in the winter. During winter, larger aircraft such as a Dash-7 and Super Hercules L100 Transport can operate from an artificially thickened ice landing strip on the lake. A gravel airstrip will be constructed at the onset of the construction period to provide year round access for similar sized aircraft.

A winter road connects Yellowknife to the Snap Lake, Ekati, and Diavik mines during February and March each year (Figure 1-1). The road is operated under a Licence of Occupation by the winter road JV Partners who operate the Ekati, Diavik, and Snap Lake mines. The road passes within 70 km of the Gahcho Kué site, at Mackay Lake. A 120 km winter road spur has been established from Mackay Lake to the project site, and was open in 1999, 2001, 2002, 2006, 2013 and 2014. The 120 km winter road spur will be constructed each year to support the mine construction and operation.

The Gahcho Kué kimberlite deposits are located within a series of mineral leases as shown in Figure 1-2. Surface rights (land leases) have been applied for by De Beers and are shown in Figure 1-3.

Figure 1-1: Location of Gahcho Kué

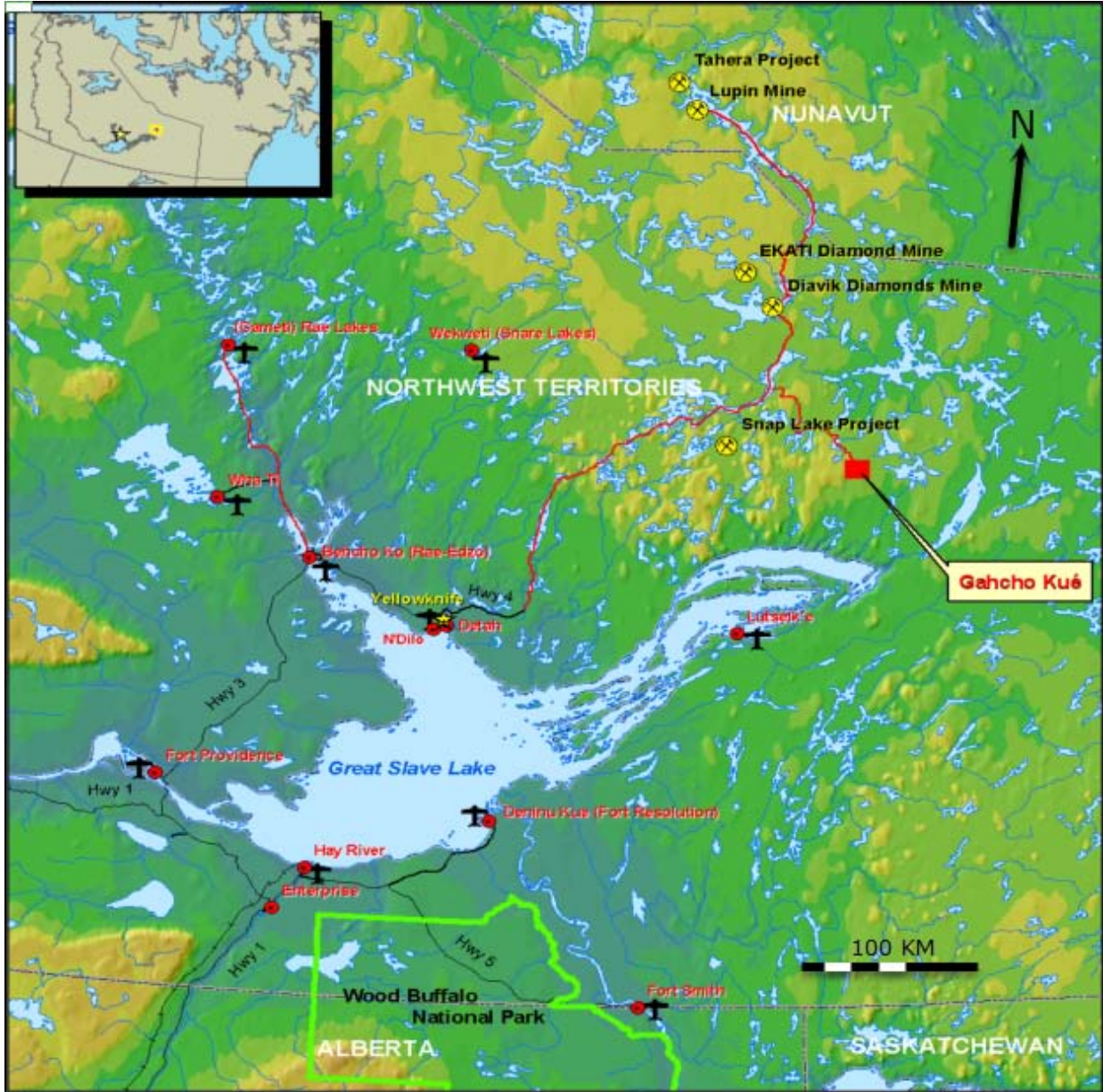

Figure 1-2: Mineral Lease Boundary Map

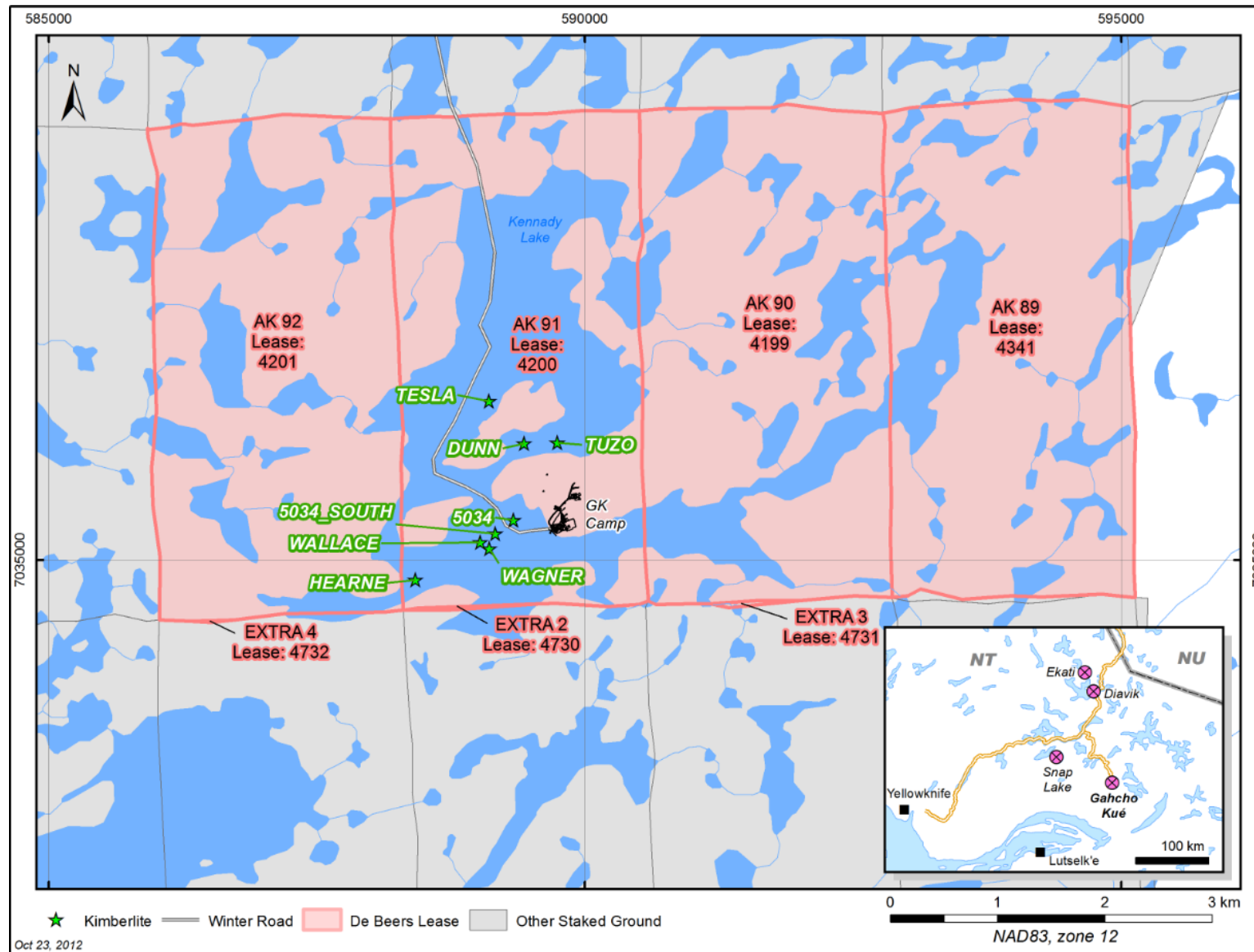
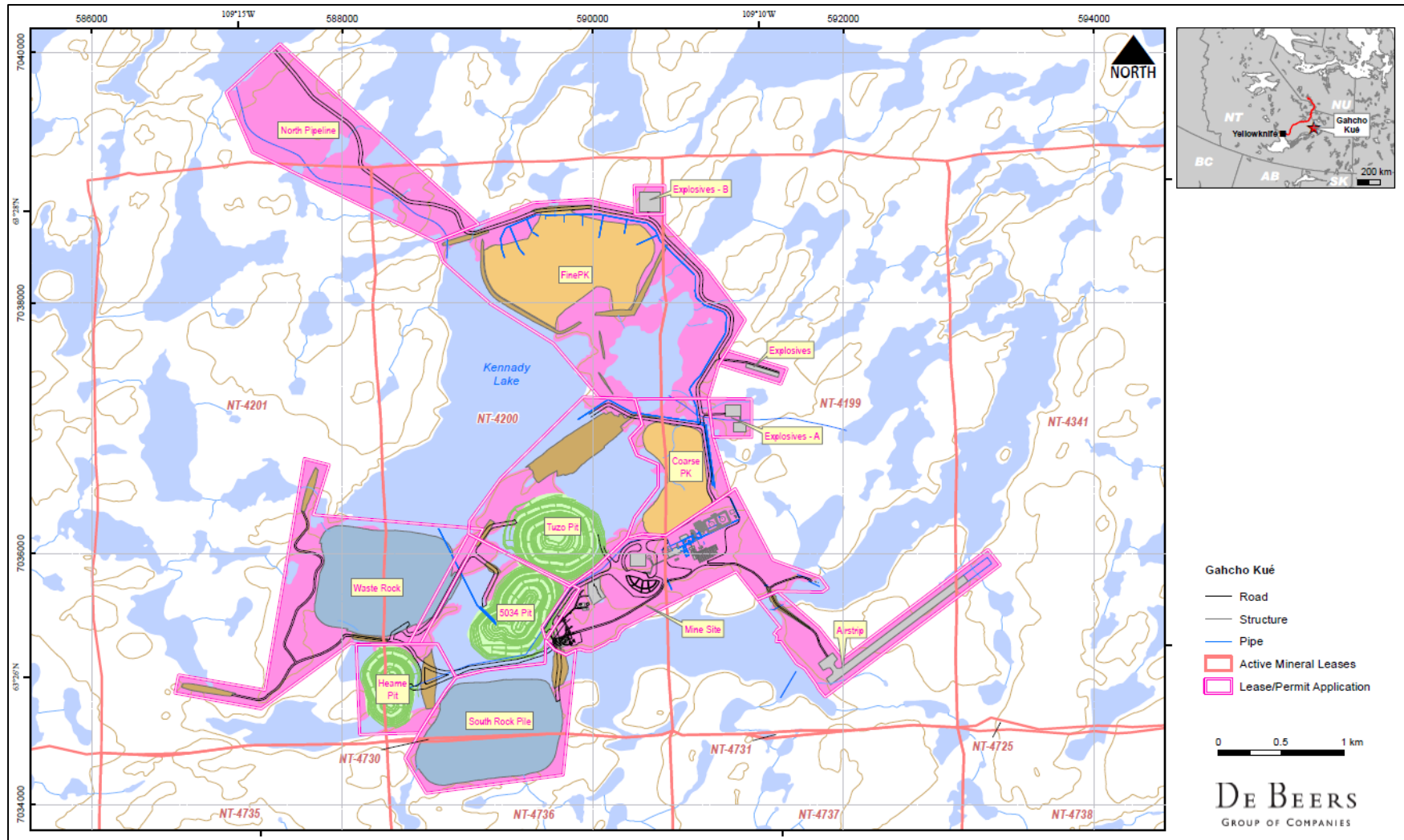

Figure 1-3: Permit Lease Boundary



1.2 Geology, Resources & Reserves

The baseline estimation and classification of the mineral resources was completed by AMEC, summarised in the “Gahcho Kué Kimberlite Project NI 43-101 Technical Report” (AMEC 2009). Additions /modifications to the AMEC mineral resource for the Tuzo Deep mineral resources deeper than 300 metres below surface (mbs) elevation are summarised in the “Update of the Mineral Resource Estimate for the Tuzo Kimberlite, Gahcho Kué Project, Northwest Territories, Canada NI 43-101 Technical Report” (Mineral Services, 2013) as a result of an additional ‘Tuzo deep’ drilling program undertaken in 2012.

The Gahcho Kué Project resources are summarised in Table 1.1. JDS has reviewed both the (AMEC2009) and (Mineral Services, 2013) resource statements and has compiled the information into a single resource estimate table for the Report. JDS is of the opinion that the resource estimates presented in Table 1.1 provide an accurate and complete basis for the feasibility study. JDS determined the appropriate conversion of resources to reserves through the mine design process and economic analysis described in the Gahcho Kué 2014 Feasibility Study Report. The optimization results and subsequent mine design have determined the economic mineral reserve estimate for each pipe as summarised in Table 1.2.

Table 1.1: Mineral Resource Summary (March 31, 2014)

Resource	Classification	Volume	Tonnes	Carats	Grade
		Mm ³	Mt	Mct	cpht
5034 - (Amec 2009)	Indicated	5.1	12.7	23.9	188
	Inferred	0.3	0.8	1.2	150
Hearne - (Amec 2009)	Indicated	2.3	5.3	11.9	223
	Inferred	0.7	1.6	2.9	180
Tuzo - (Amec 2009) (0-300 mbs)	Indicated	5.1	12.2	14.8	121
Tuzo - (Mineral Services 2013) (300-564 mbs)	Indicated	1.5	3.6	6.0	167
	Inferred	3.7	8.9	14.4	161
Summary	Indicated	14.0	33.8	56.6	167
	Inferred	4.7	11.3	18.5	163

Notes:

- (1) Mineral Resources are reported at a bottom cut-off of 1.0 mm.
- (2) Mineral Resources are not mineral reserves and do not have demonstrated economic viability.
- (3) Volume, tonnes and carats are rounded to the nearest 100,000.
- (4) Tuzo volume and tonnes exclude 0.6 Mt of a granite raft and CRX_BX.
- (5) Resources have been reported in this report to remain consistent with previous technical reports.

Table 1.2: Mineral Reserve Estimate

Pipe	Classification	Tonnes (Mt)	Carats (Mct)	Grade (cpt)
5034	Probable	13.4	23.2	1.74
Hearne	Probable	5.6	11.7	2.07
Tuzo	Probable	16.4	20.6	1.26
Total	Probable	35.4	55.5	1.57

Table 1.2 was prepared by JDS Energy & Mining Inc and complies with CIM definitions and standards for a National Instrument (NI) 43-101 Feasibility Study. Detailed information on mining, processing, metallurgical, and other relevant factors are contained in the followings sections of this report and demonstrate, at the time of this report, that economic extraction is justified.

The economic viability presented in Sections 21 and 22 confirms that the probable reserve estimates meet and comply with CIM definitions and NI 43-101 standards. At the time of this report, the project is economically viable using current diamond prices and prevailing long-term price estimates. Detailed mine planning and economic evaluation have been performed on a sub-set of the results summarised in Table 1.2.

The Gahcho Kué 2014 Feasibility Study Report did not identify any mining, metallurgical, infrastructure or other relevant factors that may materially affect the estimates of the mineral reserves or potential production.

1.3 Mining

The mine design and consequent mine plan considers indicated and inferred mineral resources of the 5034, Hearne, and Tuzo kimberlite pipes. Conventional truck/shovel mining utilising 29 m³ bucket diesel hydraulic front shovels, a 17 m³ front-end loader and 218 t class haulage trucks will be employed to mine the kimberlite and waste quantities. This large fleet will be augmented by 12 m³ bucket front-end loaders and excavators and 90 t haul trucks.

Pit designs were developed using optimised Whittle shells as a basis, and these were used to develop the mine production plan and schedule. The plans were optimised to smooth waste stripping requirements, while ensuring adequate kimberlite exposure to meet kimberlite feed requirements, as well as waste storage considerations within the Hearne and 5034 throughout the mine life.

Pre-stripping begins on land in the northern half of the 5034 pit in 2014, with the majority of the granite waste used for road, dyke and infrastructure pad construction. Unsuitable overburden material will be placed in the South mine rock pile. Mining continues in the northern portion of 5034 until 2015, when mining in the southern half of the 5034 pit begins. Full production capacity of approximately 250,000 tonnes of kimberlite per month will be reached by 5034 in January 2017.

Pre-stripping/pioneering of Hearne pit starts January 2017. Approximately half of kimberlite production will be sourced from Hearne from 2017 to 2019, slowing in 2020 as Hearne reaches the final deepest benches. Priority has been placed on mining Hearne in these years in order to open up waste storage capacity within the pit as soon as it has been completed. Hearne will be mined with no internal phases. During 2020, as Hearne is completed, equipment will begin stripping the first phase of Tuzo. Processed kimberlite will be diverted to the mined-out Hearne pit. Once dewatering is complete in 2022, Phase 1 of Tuzo will also be completed and the expansion to Phase 2 will begin. In 2023, the 5034 pit is completed. From this point on, mine rock from Tuzo will be placed in the mined-out 5034 pit. Tuzo mining continues at 3 Mt/a until 2028.

1.4 Recovery Methods

The Gahcho Kué Project will mine kimberlite resources from three different deposits: 5034, Hearne, and Tuzo. In the process plant, this material will be treated via crushing, screening, dense media separation and x-ray sorting, to produce a diamond rich concentrate that will be hand sorted on site with the resulting diamond product sent to Yellowknife for final cleaning and Northwest Territories Government valuation. The processing plant is targeting the recovery of liberated diamonds in the 1 to 28 mm size range. The processing plant is designed for efficient diamond recovery over the plant's 12-year life. The Gahcho Kué Plant processes will be automated to allow high-quality production with minimal human intervention.

1.5 Site & Infrastructure

The Gahcho Kué site is typical of many northern Canadian mining operations that lack local and regional infrastructure such as permanent road access, navigable shipping routes and ports, and external utilities. Therefore, the Gahcho Kué site requires extensive infrastructure to sustain operations, including power generation, sewage and water treatment, personnel accommodation, storage facilities for materials delivered on the limited annual winter ice road, and an aerodrome to provide year-round cargo, food and passenger aircraft access. The overall site plan is shown in Figure 1-4.

The majority of supplies during construction and operation will be shipped to site during a ten-week winter road season. A 120 km winter access spur road will be constructed each year to connect the project site to the Tibbitt-to-Contwoyto winter road at km 271, just north of Lake of the Enemy.

The layout of the site is based on several criteria:

- all major structures to be founded on bedrock
- compact footprint for minimal land disturbance and maximum site operations efficiency
- compact building sizes and layout for maximum energy efficiency
- efficient facility access for personnel and vehicles during construction and operations
- minimal impact of winter road truck traffic around the site.

Figure 1-4: Overall Site Plan

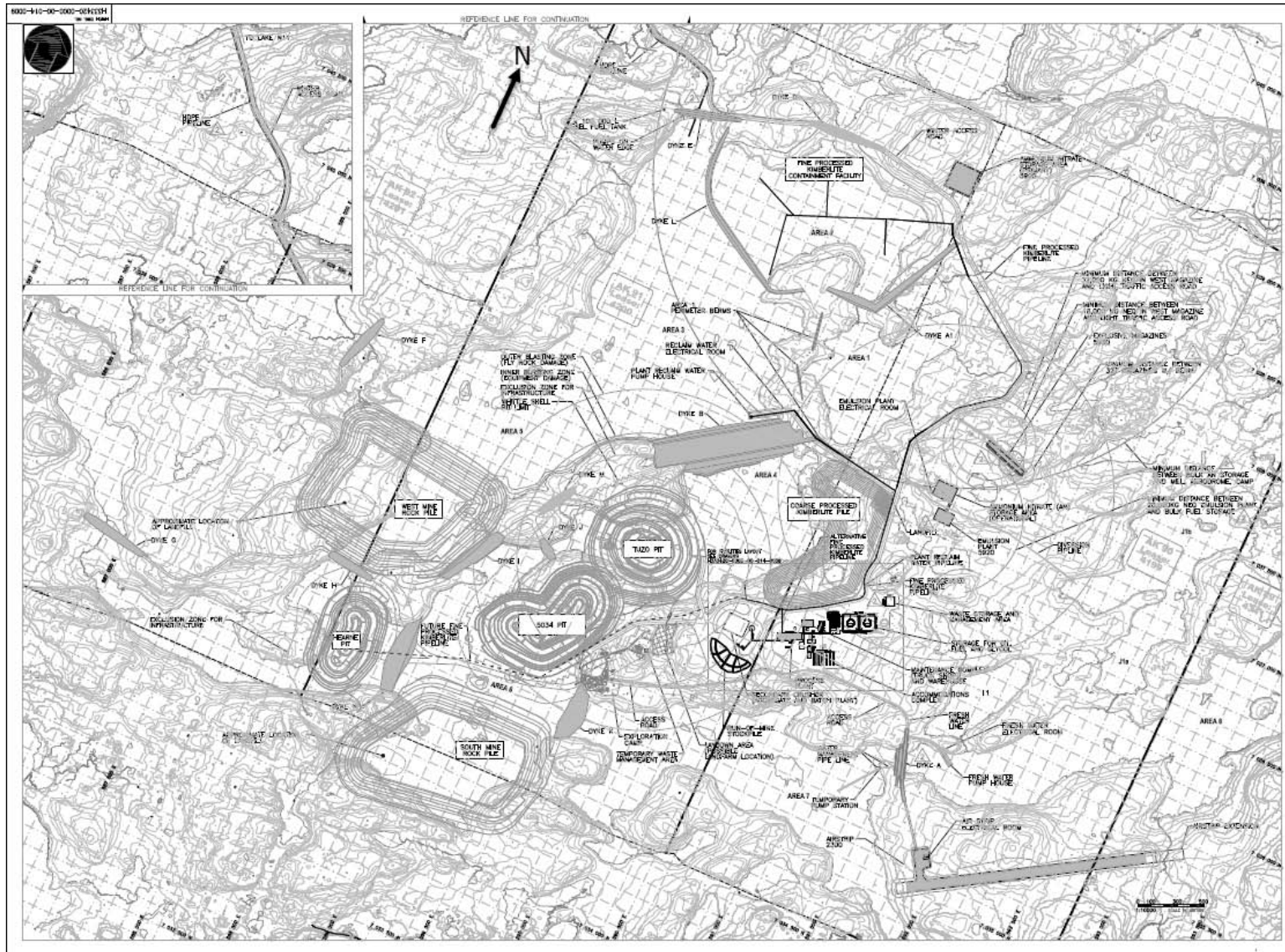

1.6 Environmental & Socioeconomic

Baseline biophysical information has been collected since 1996. In recent years, there has been a concerted effort to obtain information that will provide an appropriate basis for use in the future monitoring programs to identify potential effects and to evaluate impact predictions and monitor the efficacy of mitigation.

Multiple environmental monitoring and management plans have been prepared to track and mitigate any impact that the project has on the environment. Water management plans are adaptations of plans used successfully at other NWT diamonds mines. At Gahcho Kué, all potentially contaminated water is kept within a controlled management basin formed by natural drainage patterns. Excess storage capacity allowances created by initial lake dewatering activities provide for operational flexibility and contingencies. Normal mine operations incorporate a program of progressive reclamation that minimizes costs and allows timely monitoring of performance. The mined-out 5034 and Hearne pits are used for waste storage during the later years of the mine life providing ample time for completion of the reclamation of the waste storage areas used during the years.

De Beers has prepared an Environmental Impact Statement (EIS) for the project. Based on the EIS the Project has completed an Environmental Impact Review (EIR) process with the Mackenzie Valley Environmental Impact Review Board (MVEIRB). The MVEIRB process was completed in 2013 and based on Review Panel's recommendation, the Federal Minister approved the project on October 22, 2013, and the project entered into the permitting and licensing phase.

The Mackenzie Valley Land and Water Board (MVLWB) issued a Land Use Permit (LUP) on November 29, 2013 to undertake preliminary (early or pioneer work associated with camp, airstrip, fuel storage, equipment mobilization, etc) in preparation for the development of the Gahcho Kué diamond mine. On November 28, 2013, De Beers submitted an application for the Type A Land Use Permit (LUP) and Type A Water Licence (WL) for the Gahcho Kué diamond mine. The Water License public hearings are scheduled for early May 2014 and the expected date for receipt of the land leases, LUP and WL to allow full-scale construction is Q3/Q4 of 2014. De Beers has also made an application to Fisheries and Oceans Canada (DFO) for an authorization under the *Fisheries Act* to undertake the activities that impact fish habitat. An application will also be submitted for authorization of dykes and dams under the *Navigation Protection Act*. These permits/authorizations are expected to be in place by Q3/Q4 of 2014 to allow the mine to begin full-scale construction.

A Socioeconomic Agreement (SEA) for the project was signed with the Government of the Northwest Territories (GNWT) on June 28, 2013. The SEA establishes hiring priorities and employment incentives for the project, training and employment objectives, business procurement objectives and it outlines how De Beers and the GNWT will work together to ensure the health and cultural well-being of NWT Residents. The mine will create close to 1,000 jobs during the two-year construction phase and some 450 permanent jobs during the 12-year operational phase.

Additional employment will be created by the multitude of service providers to the project. Territorial taxes, federal taxes, and royalties are estimated to be approximately \$1,500 M during the life of the operation. In addition, property and payroll taxes will add significant tax revenues to the local municipality. Impact and Benefit Agreements (IBAs) are in place or under final stages of negotiations for the First Nation groups in the vicinity.

1.7 Project Execution

Project execution for the Gahcho Kué Project is based on tested and proven principles utilised in the development of diamond mines in the Canadian Arctic.

The only road access to site will be an ice road that will be used to transport all heavy and bulky material. The ice road is open for two months every year, generally in February and March. The execution strategy has been developed around this constraint. People and goods for the camp will be flown into the site area along with smaller and lighter equipment and material required for the construction work that can be mobilised by air. Until the airstrip is operational, personnel will be flown in via small aircraft during the summer and large fixed-wing aircraft landing on an ice airstrip during winter.

Procurement activities started in the fall of 2013 for packages critical to the 2014 winter road. All future activities have taken into consideration lead time for equipment, bulks and fabrication as well as quality inspection requirements and the need for on-site expediting. Lead times were established through contact with potential bidders during the fall of 2013.

Engineering activities have been well advanced in the feasibility study phase. All long lead equipment has been purchased and the early works packages to be constructed in 2014 have been developed so that construction can be well planned and executed in a safe manner. Engineering has been sequenced from construction and procurement activities so that equipment and facilities are designed in time to order and deliver components and materials to site as scheduled.

Table 1.3 highlights the key project milestones of the project.

Table 1.3: Key Period Milestones

Milestone	Start	Finish
Pioneer Works Permit Issued / Start work	Dec. 2013	
2014 Ice Road	Feb. 2014	March 2014
Air Strip Operational		May 2014
Permanent Camp Installation	June 2014	Sep. 2014
Land Use Permit/Water Licence Issued	Oct. 2014	
2015 Ice Road	Feb. 2015	March 2015
Concrete Works	April 2015	
Mechanical Works	May 2015	May 2016
Emulsion Plant Completed		Dec. 2015
Truck Shop Completed		Dec. 2015
2016 Ice Road	Feb. 2016	March 2016
Process Plant Mechanical Completion		May 2016
Commissioning Commence	May 2016	
First Kimberlite in Plant	Sept. 2016	
Ramp Up To Full Production	Sept. 2016	Jan. 2017

1.8 Capital Cost Estimate

The capital cost estimate is based on:

- Contingency established via Quantitative Risk Analysis (QRA).
- A combination of committed and firm bid prices for major mobile mining equipment
- Budget prices for the minor mobile equipment.
- Firm and budget proposals for select equipment packages.
- Material Take-Offs (MTOs)
- Labour rates were from the general contractor (Ledcor Projects Inc.)
- Committed unit labour rates for earthworks equipment operators
- Labour productivity based on historical project experience with cold environment projects.
- Freight cost calculations.
- The project schedule outlined in 2014FS Report execution plan.
- Detailed estimates of indirect costs.
- Applying escalation to costs scheduled to be spent beyond 2013.

The capital cost for the project is C\$1,019 million including C\$75.6 million of contingency.

Table 1.4 summarizes the capital cost by WBS.

Table 1.4: Capital Cost Estimate by WBS

WBS	Description	CAD (M)
1000	Mine Operations	188.8
2000	Site Development & Roadworks	10.3
3000	Process Facilities	134.4
4000	Utilities	48.9
5000	Ancillary Buildings	51.8
6000	Waste & Water Management	6.1
7000	Off-site Facilities	0.4
Subtotal - Direct Costs =		440.7
8000	<i>Owner's Management Costs</i>	100.2
9000	<i>Indirect Costs</i>	360.5
Subtotal – Owners + Direct Costs =		460.7
9900	Contingency	75.6
9910	Escalation	42.0
Total - Projects		1,019.0

The \$1,019 M capital costs figure shown in Table 1.4 includes Sunk Costs for 2011, 2012 and 2013 totalling \$118.6 M. The capital cost includes escalation during construction the construction phase \$42.0 M; but excludes initial working capital (\$80.1M) and operating costs during the ramp up phase (\$81.9). Excluding the sunk costs the total capital required (in 2013 dollars) prior to commercial production is \$1,020.5 M.

1.9 Operating Cost Estimate

The operating cost estimate was developed by JDS based on first principles and by applying direct applicable project experience and avoiding the use of general industry factors. JDS is of the opinion that the operating cost estimate is an accurate representation of the mine operating costs based on the reasonable inputs and assumptions made at the time.

Operating cost estimate inputs were provided by De Beers, based on operating experience at the Snap Lake Mine in the NWT and the Victor Mine in Northern Ontario. The operating cost estimates use the labour classification and wage scales currently employed by Snap Lake, and much of the G&A cost estimate details were derived from actual cost data from the Snap Lake mine.

Certain sectors of the operating costs begin during the construction phase (mining, power generation, freight, and G&A) and continue through the life of the mine. All costs incurred during the construction phase have been capitalised and are part of the capital cost estimate.

The target accuracy of the operating cost estimate is -5%/+15%, which represents a Feasibility Study Budget/Class 3 Estimate. The average annual operating cost estimate and average LOM unit costs for the Gahcho Kué project are summarised in Table 1.5 in Q3 2013 Canadian dollars.

Table 1.5: Operating Cost Estimate Summary

WBS	Description	Average Annual Cost (\$)	Average Mined (\$/t)	Average Processed (\$/t)
A	Mine	98,505,321	3.49	33.24
B	Process	22,118,252	0.78	7.46
C	Power	17,886,381	0.63	6.04
D	Freight	18,646,525	0.66	6.29
E	G&A	41,701,193	1.48	14.07
F	Contingency	7,198,648	0.26	2.43
G	Management Fee	6,361,794	0.23	2.15
-	Total	212,418,114	7.54	71.68

Note: Unit costs per tonne mined are presented against materials mined in the operational phase only. Cleaning/Sorting cost at \$0.546/ct (\$0.83/t processed) is in addition to the \$71.68/t processed (\$72.51/t processed).

1.10 Financial Analysis

The financial evaluation of the project has been undertaken on an after-tax, unleveraged, real rate of return to the GK Project JV partners as a whole. The analyses assumed that three kimberlite bodies will be developed, with production on the first pipe (5034) starting in September 2016 as part of the scheduled plant ramp up. Mill feed, derived from indicated reserves with modelled carats plus limited additional material at zero carat grade (as mill feed dilution), was used in the 2014 FS. Production, including ramp up, extends over roughly 12 years. All production, costs and revenues are based on calendar fiscal years.

The project provides a real rate of return to the partners of 32.6% and a real net present value (NPV) at 10% of C\$1,004.8 M in calendar 2013 Canadian dollars, excluding all sunk costs to the end of 2013. In the scenario of including sunk costs incurred to end of 2013, the project provides a real rate of return of 21.9% and a real NPV at 10% of C\$747.3 M. In the sunk cost excluded scenario, the project is most sensitive to changes in diamond prices, with real dollar returns decreasing the IRR by 4.5% for a 10% reduction in prices and increasing the IRR by 4.2% for a 10% increase in prices. The project shows a lesser sensitivity to capital with IRR figure changing by +3.1%/-2.7% for a ±10% change in capital. The sensitivity to operating cost is ±1.4% for a ±10% change in the operating costs.

1.11 Conclusions

The Authors are of the opinion that the Project is economically viable, technically credible, and environmentally sound.

The Project is economically viable, generating C\$7,720.8 M in RV (realised value) revenues over a 12-year mine life resulting in a 32.6% IRR (real rate of return) and a \$1,004.8 M NPV (net present value) at 10% excluding sunk costs of \$259.5 M incurred prior to Dec 31, 2013. Including sunk costs of the project yields a 21.9% IRR and \$747.3 M NPV. Total life of mine (LOM) capital costs are estimated at \$1,290.8 M consisting of: \$140.9 M sunk costs (pre-2011); \$118.6 M sunk costs (2011-2013); \$858.5 M initial capital; \$80.1 M working capital; and \$92.7 M sustaining and closure costs. Total LOM pre-tax

cash operating costs are estimated at \$2,542.8 M, which equates to \$72.51/t processed or \$47.62/ct recovered. Operating costs incurred during the initial ramp up phase are estimated at \$81.9 M.

The Project is technically credible, utilising designs and practices that are proven in the Canadian diamond industry. The project design is based on the open pit mining of the 5034, Hearne and Tuzo deposits in a concurrent/sequential fashion (5034 and Hearne mined initially followed by Tuzo). Mine plans call for the extraction of 315 Mt of waste and 35.1 Mt of mill feed over a 15-year period (including construction/pre-production) utilising industry standard drill/blast equipment, truck/shovel equipment and pit designs that are similar to other open pit diamond mines operating in the area. The kimberlite processed includes Mineral Reserves, as well as an additional 1.2 Mt of dilution that will be processed through the mill. This added tonnage is at zero grade and does not provide any additional revenue, and is comprised of external waste at depth that is included in the pit design and is not classified as an Indicated Resource. Kimberlite will be fed to a 3.0 Mt/a processing plant with three stages of crushing, DMS, and X-ray/grease diamond recovery circuits. Process plant designs and equipment selections are based on experience from other De Beers operations and utilize proven suppliers. Security measures and designs are based on current De Beers' standards and practices.

1.12 Recommendations

The Gahcho Kué 2014 Feasibility Study Report indicates a robust project based on the assumptions made of the diamond recovery, execution plan, and the market. The Authors recommend the following:

- the project be funded for development
- the project advance to the full project expenditure decision by the Owners to proceed with the detail design and construction of the Gahcho Kué Diamond Mine
- full funding/commitment and start of major construction should be subject to and contingent upon the receipt of the final environmental permits under terms and conditions acceptable to JV partners.

SECTION 2 INTRODUCTION

2.1 Report Preparation

Hatch and JDS Energy and Mining Inc (JDS) were commissioned by De Beers Canada Inc (DBCI or De Beers) on behalf of the Gahcho Kué Joint Venture (GKJV, consisting of De Beers 51% and MPV 49%) to compile the Gahcho Kué 2014 Feasibility Study Report for the Gahcho Kué project (the Project), located in Northwest Territories, Canada. The Technical Report (This Report), was compiled for Mountain Province Diamonds Inc. (MPV) to provide a summary of the Gahcho Kué 2014 Feasibility Study Report findings and was prepared in compliance with National Instrument 43-101, *Standards of Disclosure for Mineral Projects* (43-101). This Report is intended for the use of MPV as a GKJV partner for the further development and advancement of the project.

This Report has been compiled by Hatch and JDS (the Authors and Qualified Persons). The areas of key responsibilities are as follows:

JDS Energy & Mining – Responsible for pit optimization, mine design, mine planning, mine capital cost development, overall operating cost development and financial analysis. JDS was assisted by principal designated project contractors and subcontractors providing report information as noted below:

- SRK Consulting Canada (SRK): Geotechnical design and geotechnical pit design parameters.
- EBA Engineering Consultants Ltd. (EBA): Waste and water management plans, waste rock storage geotechnical design, dyke design, construction geotechnical study.

Hatch – Responsible for processing plant design, site infrastructure design, project schedule, project execution plan and project capital cost development and risk analysis. Hatch was assisted by the principal designated project contractors and subcontractors providing report information as noted below:

- ADP – DMS and Recovery Plant Design
- Ledcor – Designated General Contractor – Construction cost estimating.

Information used to support the Report was derived from the Gahcho Kué Kimberlite Project NI 43-101 Technical Report (AMEC 2009); the Gahcho Kué Project Definitive Feasibility Study NI 43-101 Technical Report (JDS – Dec. 2010) and the Update of the Mineral Resource Estimate for the Tuzo Kimberlite, Gahcho Kué Project, NI 43-101 Technical Report (Mineral Services 2013). Sections 7 through 14 of the report have been derived from the AMEC 2009 Technical Report (AMEC, 2009) and the Mineral Services 2013 Technical Report (Mineral Services, 2013), and are repeated in this report for completeness. The Authors have, within their areas of responsibility, reviewed these previous reports

and are of the opinion the information contained in these sections is accurate. The 2009 AMEC Technical Report provided mineral resource estimates for the 5034, Hearne and Tuzo deposits. Additional drilling was conducted on the Tuzo deposit in 2011. The new drilling information was incorporated in the Mineral Services 2013 Technical Report, which provided and updated mineral resource estimate for the Tuzo deposit.

The Gahcho Kué 2014 Feasibility Study Report environmental and socioeconomic sections were prepared by Golder under contract to De Beers. Detailed summaries of these sections have been included in the Technical Report as Sections 23.6 and 23.7. The Authors have reviewed all the information contained in the environmental and socioeconomic sections and are of the opinion that the information and data is adequate for the Report.

Additional information was provided by or prepared by De Beers Canada Inc as the project operator. As the Project operator, De Beers was responsible for unit labour costs, environmental permitting, diamond prices, certain G&A costs, operational readiness plans, economic analysis parameters, geological block model and resource estimates (as prepared independently prepared by AMEC and Mineral Services), and diamond price valuations (as prepared by DTC and WWW International Diamonds Consultants (WWW), WWW prices were provided to De Beers via Mountain Province. Hatch and/or JDS reviewed the material provided by De Beers and considered the information provided adequate for use in the Gahcho Kué 2014 Feasibility Study Report. JDS and Hatch are of the opinion that the same information used in the Gahcho Kué 2014 Feasibility Study Report is adequate for use in this Report.

2.2 Qualifications & Responsibilities

Four Qualified Persons (QPs), as defined by NI 43-101, were responsible for the preparation of this Technical Report. Table 2.1 lists the qualifications for each QP, as well as the section(s) of the report for which they are responsible.

Table 2.1: Gahcho Kué NI 43-101 Qualified Person Responsibility

Qualified Person	Company	Report Section(s) of Responsibility
Daniel Johnson, P.Eng.	JDS	Sections 1-12; Section 14; Section 21.1.2 and 21.1.3; Section 23; Sections 24.2, 24.3, 24.4; Sections 25-27
Ken Meikle, P.Eng.	JDS	Section 19; Section 21.2; Section 22
Dino Pilotto, P.Eng.	JDS	Section 15; Section 16
Kato Lone, Eng.	Hatch	Section 13; Sections 17-18; Section 20; Section 21.1 and 21.1.1; Section 24.1, 24.5, 24.6

2.3 Site Visits

The QPs made several site visits, as listed below:

- Daniel D. Johnson, P. Eng., Project Director (JDS). Site visits on 18 September 2007, 1 August 2013, 15 February 2014 and 15 April 2014.
- Kenneth Meikle, P. Eng., Principal Mine Engineer (JDS). One site visit: 25-26 June 2012.
- Dino Pilotto, P. Eng., Principal Mine Engineer (JDS). No site visit.
- Kato Lone, Eng., Project Manager – Gahcho Kué 2014 Feasibility Study Report (Hatch). One site visit: 1 August 2013.

2.4 Currency

Costs in this report are provided in Canadian dollars (CAD or C\$), unless otherwise specified. US dollars (USD or US\$) are also used.

2.5 Units of Measure & Abbreviations

Unless otherwise specified, all units of measure in this report are metric.

A list of main abbreviations and terms used throughout this report is presented in Table 2.2.

Table 2.2: Units of Measure & Abbreviations

Units of Measure

'	Foot
"	Inch
µm	Micron (micrometre)
A	annum
A	Ampere
Ac	Acre
Ag	Silver
Au	Gold
cfm	Cubic feet per minute
cm	Centimetre
Cu	Copper
d/a	Days per annum
Dmt	Dry metric tonne
ft	Foot
ft ³	Cubic foot
g	Gram
h	Hour
Ha	Hectare
hp	Horsepower

in	Inch
kg	Kilogram
km	Kilometre
km ²	Square kilometre
kPa	Kilopascal
kt	Kiloton
kW	Kilowatt
kWh	Kilowatt hour
L	Liter
lb	Pound
m	Metre
M	Million
m ²	Square metre
m ³	Cubic metre
min	minute
mm	Millimetre
MPa	Mega Pascal
mph	Miles per hour
Mt/a	Million tonnes per annum
Mt	Million tonnes
°C	Degree Celsius
°F	Degree Fahrenheit
oz	Troy ounce
Pa	Pascal
ppb	Parts per billion
ppm	Parts per million
psi	Pounds per square inch
S	Second
T	Metric tonne
t/d	Tonnes per day
t/h	Tonnes per hour
V	Volt
W	Watt
wmt	Wet metric tonne
Zn	Zinc

SECTION 3 RELIANCE ON OTHER EXPERTS

The QPs, authors of this report, state that they are Qualified Persons for those areas as identified in the certificates of Qualified Persons. The Authors have relied upon information derived from previous reports pertaining to mineral rights, surface rights and permitting issues.

3.1 Mineral Tenure

JDS has not independently verified the complete legal status or ownership of the Project area, the mineral tenure, or underlying property agreements. JDS has however reviewed the public registry and mine recorder records with regard to mineral leases and the applications for surface leases ; and are of the opinion that the mining tenure held by De Beers on behalf of the GKJV is valid and sufficient to support Mineral Reserves and plans for mine development.

JDS has reviewed the Amended and Restated Joint Venture Agreement dated July 2009 between De Beers Canada, Mountain Province Diamonds, and Camphor Ventures and was found to accurately reflect the participating interests of the joint venture partners as of the effective date of this Report.

3.2 Diamond Valuations

JDS has relied on WWW International Diamond Consultants (WWW) for diamond valuation. WWW are recognised international leaders in this field, and are the valuers to the Federal Government of Canada for the Canadian diamond mines in the Northwest Territories. This information was used in support of Item 22 Economic analysis. JDS has also relied on De Beers (DTC marketing division) for diamond valuations along with the WWW diamond valuations, in accordance with the GKJV agreements, in support determining the reserves (Item 15). JDS believes it is reasonable to rely on De Beers valuations, as the Diamond Trading Company (DTC) is the rough diamond distribution arm of the De Beers Companies and is the world's largest supplier of rough diamonds.

Similarly, JDS has relied on De Beers and MPV for the diamond price escalation estimate. De Beers and MPV conducted their own market analysis and determined that a 1.5% real growth rate in USD diamond prices be used in the financial analysis which has been accepted as reasonable for the current market.

For the financial analysis, the diamond prices reference a non-public report: *Re-Price & Modelling of the Average Price of Diamonds from the Gahcho Kué Diamond Project – February 2014* (WWW 24-Feb-2014), which JDS has reviewed and accepts as reasonable. In reviewing this report or associated references, no significant additional risks beyond the modelled price ranges discussed in Items 19 and 22 were detected.

3.3 Other Information Sources

In preparing the Gahcho Kué 2014 Feasibility Study Report, Hatch and JDS have relied on inputs from De Beers, Mountain Province and a number of well-qualified independent consulting groups, particularly regarding socioeconomic and environmental issues. In general, the inputs were the end result of multidisciplinary professional/technical collaboration over a period of years and include the knowledge and experience within Hatch and JDS in the design, construction and operations of open pit diamond mines in Canada. Therefore, Hatch and JDS are of the opinion that the inputs are reasonable and adequate for this Report. Major information sources are noted below.

Supporting Information Sources

Major area(s) of Input

Golder Associates LLC

Permitting, Environmental and Socioeconomic.

De Beers Canada Inc

Operating Cost Estimate Inputs derived from other De Beers operated Canadian diamond mines;

Security, as it relates to diamond security design and operations;

Legal as it relates to leases, licenses and permits required to operate a mining operation in the NWT;

Operational Readiness, as in a planning/staffing program for the Gahcho Kué operation;

Government Relations and Socioeconomics, in terms of socioeconomic agreements and relations/interfaces with Government, and IBA (Impact and Benefit Agreements) with area stakeholders;

Permitting, in terms of obtaining and maintaining all permits required to allow the Project to proceed and operate; and,

Mineral Tenure, provided mineral lease information and surface lease application information and property agreements related to the GKJV.

SECTION 4 PROPERTY DESCRIPTION & LOCATION

4.1 Location

The Gahcho Kué Project is located at the informally-named Kennady Lake, approximately 300 km east-northeast of Yellowknife in the District of Mackenzie, Northwest Territories, Canada, at the approximate latitude 63.26.16N and longitude 109.12.05W (NAD83 Zone 12 coordinates 7035620N, 589735E (Figure 4-1).

Figure 4-1: Location of Gahcho Kué

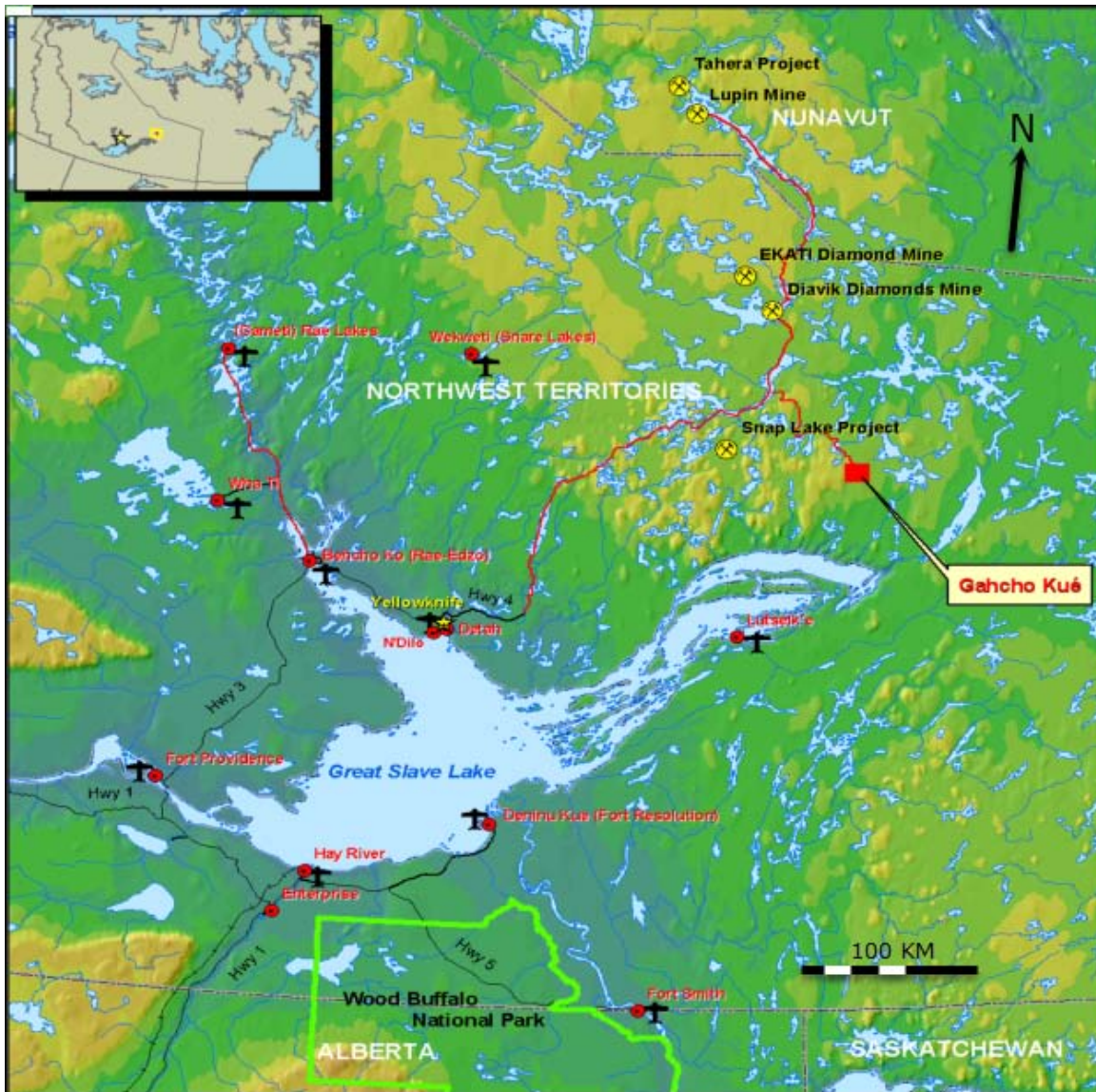

The Project is located 150 km south–southeast of the Diavik and Ekati diamond mines operated by Diavik Diamonds Inc (Rio Tinto) and Dominion Diamonds respectively at Lac de Gras, and 80 km east–southeast of the De Beers Snap Lake mine.

The Gahcho Kué Project consists of Hearne North and South; 5034 West, Central and North-East; 5034 South Pipe; 5034 North Pipe; and Tesla diamondiferous kimberlite pipes, sheets and dykes. Except for the northernmost part of 5034, the main kimberlite pipes all lie beneath Kennady Lake. Only the 5034, Hearne, and Tuzo pipes are adequately explored to allow estimation of Mineral Resources. A number of other kimberlite occurrences were explored, but currently have insufficient data to support Mineral Resource estimation.

4.2 Tenure History

The Gahcho Kué Project was part of a larger group of mining claims, known as the AK Property, which currently consists of four remaining mining leases (Figure 4-1 and Table 4.1). The AK Property was initially staked in 1992 by Inukshuk Capital Corp., and optioned to Mountain Province Mining, Inc. (now Mountain Province Diamonds, Inc – MPV) later the same year.

On staking, the project covered about 520,000 ha, and included the AK and CJ claims. The CJ claims substantially lapsed in November 2001, and the remaining CJ claims lapsed on August 17, 2002, leaving only the AK claims as current at that time.

Additional partners in the AK Property included Camphor Ventures Inc. (Camphor Ventures), and 444965 B.C. Ltd, a subsidiary company of Glenmore Highlands Inc. (Glenmore Highlands). At the time, Glenmore Highlands was a controlling shareholder of Mountain Province Mining Inc. as defined under the Securities Act of British Columbia. The Glenmore Highlands subsidiary amalgamated with MPV in 1997, and Camphor Venture’s interest in the AK Property was acquired by MPV during 2007.

In 1997, Monopros (now De Beers Canada) joint ventured the property. The currently applicable agreements between the partners are summarised in Section 4.4. Surrounding claims/leases were dropped and the remaining leases comprising of the Gahcho Kué Project are described below.

4.3 Mineral Tenure

The Gahcho Kué Project comprises four mining leases, 4199, 4341, 4200, and 4201, covering a total area of 10,353 ha (Figure 4-1 and Table 4.1). The mining leases are 100% owned by De Beers Canada Inc. who holds them on behalf of the GKJV. The participating interest of each of the GK joint venture parties is governed by the 2002 joint venture agreement as updated in 2009, which is registered against the mineral leases (see Section 4.4).

Annual lease payments, payable to the Receiver General Canada (Northwest Territories, c/o Mining Recorders Office), comprise \$1.00 per acre for the duration of the 21-year lease period (note that fees are payable on acres, not hectares, in the NWT and Nunavut). Payments increase to \$2.00 per acre if a

second 21-year term is granted after application to the Northwest Territories Mining Recorder for the extension.

All mining leases were legally surveyed by licensed surveyors.

JDS is of the opinion that the leases are valid and in good standing until the expiry dates in Table 4.1. Renewal of the leases is required in 2023.

Immediately to the south, and contiguous with the Project mining leases are three “sliver claims”, mining leases 4732, 4730 and 4731 (Figure 4-1). The leases have a total area of 11.52 acres, and are held in the names of De Beers Canada Inc. (55.5%), Mountain Province Diamonds Inc. (24.5%) and GGL Diamond Corp. (20%).

4.4 Agreements

The Monopros Ltd. Joint Venture Agreement, dated 6 March 1997, was entered into between Monopros Ltd. (Monopros; a wholly-owned Canadian subsidiary of De Beers Consolidated Mines and now known as De Beers Canada Inc.), MPV, and Camphor Ventures. The parties amended the Monopros Ltd. Joint Venture Agreement in 2000.

An updated and expanded JV Agreement between De Beers and MPV became effective on 1 January 2002, was signed 24 October 2002. This agreement provides that De Beers Canada could earn up to a 55% interest in the project by funding and completing a positive definitive feasibility study. The agreement also provides that De Beers Canada could earn up to a 60% interest in the project by funding development and construction of a commercial-scale mine.

MPV acquired Camphor Ventures’ interest in the joint venture in 2007.

A further updated and amended JV agreement between De Beers and MPV was executed effective 3 July 2009. The JV agreement superseded the previous JV agreements. The agreement maintains the project ownership at 51% De Beers and 49% MPV. Each party responsible for funding their respective share of the project development costs from 1 January 2009 onward, and each party shall receive a proportional share of the diamond production.

The amended agreement also sets forth the amount of “allowable” expenses of exploration work between 8 March 2000 and 31 December 2008 previously funded by De Beers, and sets forth a repayment schedule by MPV to De Beers for their 49% share of the allowable expenses. The repayment schedule is triggered by milestone events with the final payment being made on the due date, which is defined as 15 months after the start of commercial production.

A joint venture agreement was signed between De Beers, MPV and GGL Diamond Corporation on 28 February 2006, under which MPV has an interest in the three sliver claims (see Table 4.1). This agreement is still current.

Figure 4-2: Gahcho Kué Project Mining Lease Land Holdings

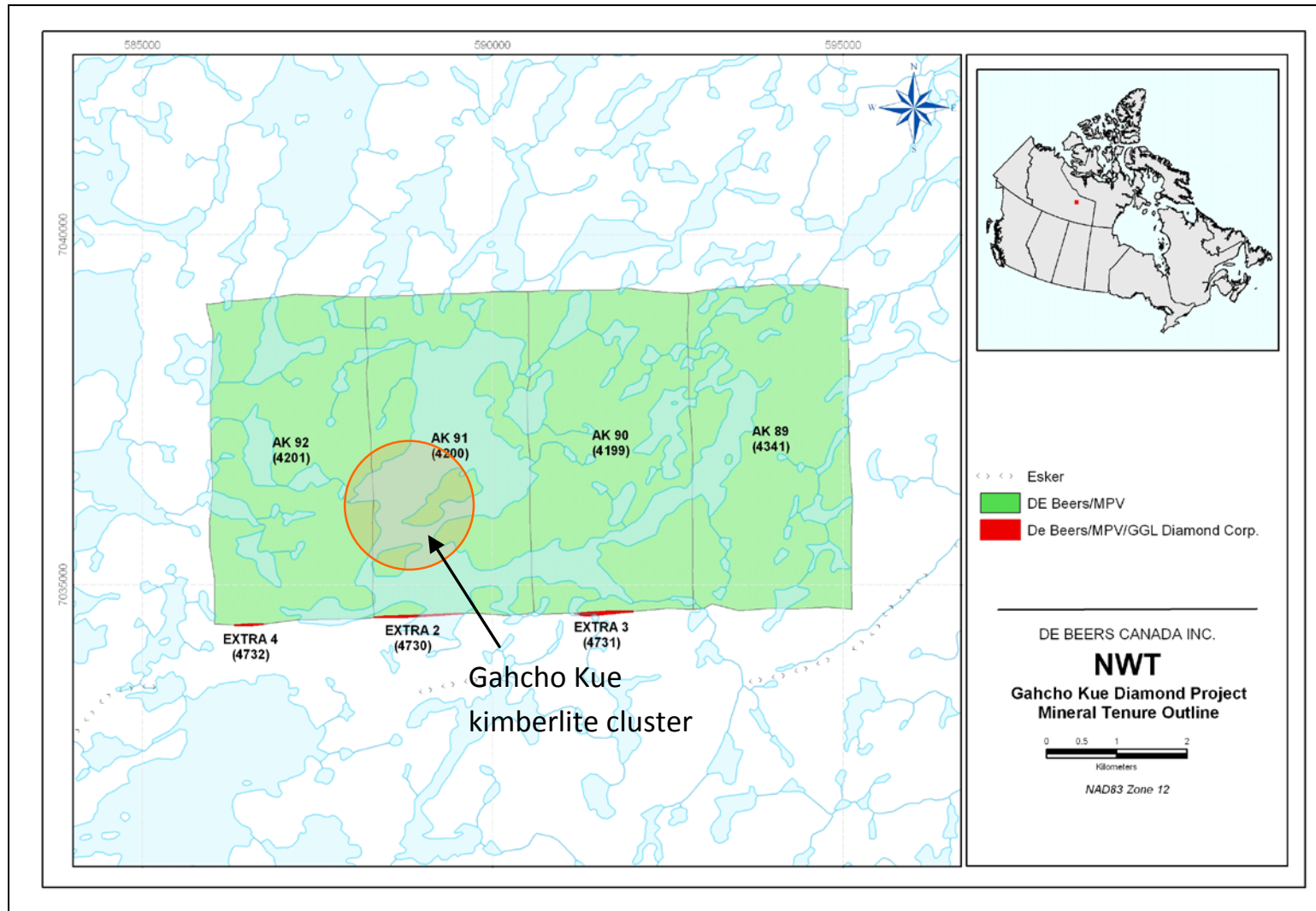

Note: Mining lease boundaries for 4732, 4730, and 4731 are approximate at this scale.

Table 4.1: Mineral Tenure Summary

Number	Tenure Type	Area (acres)	Date Granted	Expiry Date	Holders and Ownership Percentages
<i>Gahcho Kué Project</i>					
4199	Lease	2,607	15-Jul-02	15-Jul-23	De Beers Canada Inc. on behalf of the GKJV. The participating interest of each of the GKJV parties is governed by the 2002 Joint Venture Agreement, which is registered against the mineral claims. Interests in the GKJV are De Beers Canada Inc (51%), Mountain Province Diamonds (49%)
4200	Lease	2,579	15-Jul-02	15-Jul-23	De Beers Canada Inc. on behalf of the GKJV. The participating interest of each of the GKJV parties is governed by the 2002 Joint Venture Agreement, which is registered against the mineral claims. Interests in the GKJV are De Beers Canada Inc (51%), Mountain Province Diamonds (49%)
4201	Lease	2,590	15-Jul-02	15-Jul-23	De Beers Canada Inc. on behalf of the GKJV. The participating interest of each of the GKJV parties is governed by the 2002 Joint Venture Agreement, which is registered against the mineral claims. Interests in the GKJV are De Beers Canada Inc (51%), Mountain Province Diamonds (49%)
4341	Lease	2,577	17-Jul-02	17-Jul-23	De Beers Canada Inc. on behalf of the GKJV. The participating interest of each of the GKJV parties is governed by the 2002 Joint Venture Agreement, which is registered against the mineral claims. Interests in the GKJV are De Beers Canada Inc (51%), Mountain Province Diamonds (49%)
Total		10,353			
<i>Sliver Claims</i>					
4730	Lease	4.92	1-Apr-05	1-Apr-26	De Beers Canada Inc (55.5%), Mountain Province Diamonds (24.5%) and GGL Diamond Corp (20%)
4731	Lease	5.76	1-Apr-05	1-Apr-26	De Beers Canada Inc (55.5%), Mountain Province Diamonds (24.5%) and GGL Diamond Corp (20%)
4732	Lease	0.84	1-Apr-05	1-Apr-26	De Beers Canada Inc (55.5%), Mountain Province Diamonds (24.5%) and GGL Diamond Corp (20%)
Total		11.52			

4.5 Surface Rights

Crown lands are lands owned by the federal or provincial governments. Authority for control of these public lands rests with the Crown, hence their name. Crown land and Commissioner's land are both types of public lands. The Federal Government manages and administers Crown land in Canada. In the Northwest Territories, Aboriginal Affairs and Northern Development Canada (AANDC) is responsible for the majority of Crown land. Effective April 1, 2014 the responsibility for public land, water and resource management in the Northwest Territories will shift from AANDC to the Government of the Northwest Territories (GNWT). Public land is managed and administered by the Government of the Northwest Territories, and specifically, by the Department of Municipal and Community Affairs (MACA).

Administration of Crown lands, including minerals for the Northwest Territories and Nunavut, is based on the Territorial Lands Act (TLA) and its regulations. The Regulations under the TLA that deal with mineral tenure, leasing and royalties are the Northwest Territories and Nunavut Mining Regulations (NTNMRs), formerly known as the Canada Mining Regulations (CMRs). Under the current NTNMRs, a party may prospect for minerals and stake mineral claims on any Crown lands covered under the TLA, including lands in and around the area of the Mackenzie Valley.

A surface lease is required under the Territorial Lands Act if a project will require the use of Crown land anywhere in the NWT for longer than two years. A surface lease does not convey ownership to the minerals on or under the leased property. Those minerals require a mineral lease (refer to Section 4.3). The first step to acquire a surface lease is to submit an application for use of Crown land. For activities taking place in the Mackenzie Valley on Crown land, applications are made to the Mackenzie Valley Land and Water Board. The Mackenzie Valley, as defined in the Mackenzie Valley Resource Management Act, includes all of the Northwest Territories, with the exception of the Inuvialuit Settlement Region and the Wood Buffalo National Park. JDS has confirmed that De Beers has filed applications for the surface leases, however there is no guarantee that surface leases will be issued in a timely manner or will contain terms and conditions that are acceptable to the GKJV partners. The leases applied for are depicted in Figure 4-3. Surface rights for construction of a diamond mine—including the plant, access roads, airstrip, and accommodations—have not yet been granted.

The Gahcho Kué Project is currently operated under by authority of land use permits and water licences. JDS has confirmed that valid licenses are currently in place for exploration and initial pioneering construction activities. JDS has verified that a Type A Land Use Permit (permit number MV2013C0019, expiry date 28 November 2015); a Quarry Permit (permit number MV2014Q0008 and a Type B Water License (permit number MV2003L2-0005, expiry date 22 April 2015) are current valid and in place.

Figure 4-3: Permit Boundary Map

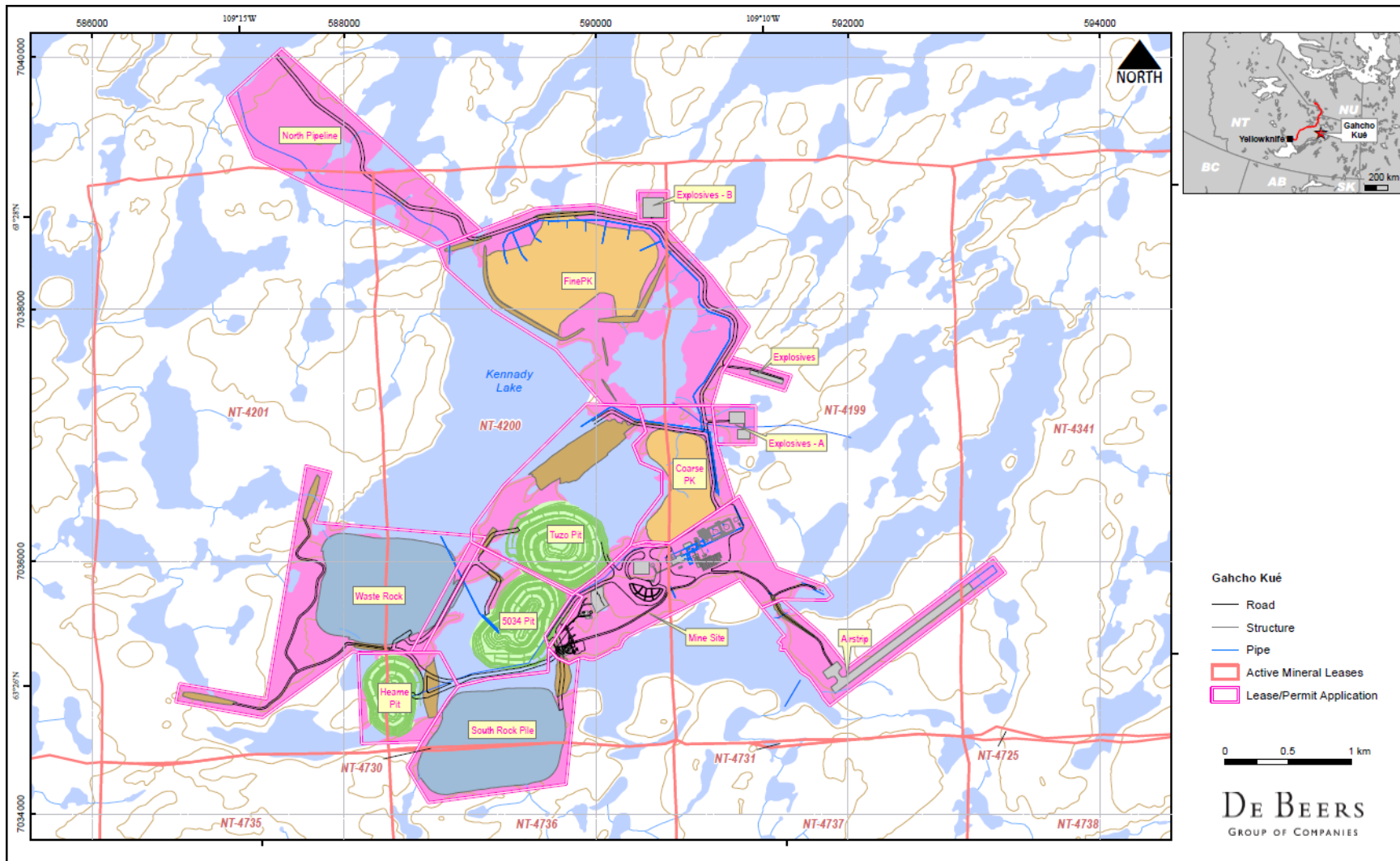

4.6 Permits

4.6.1 EXPLORATION PROGRAMS

Exploration programs to date were conducted under the permits obtained from the appropriate authority, including:

- Indian and Northern Affairs Canada – Type A Land Use Permit
- Indian and Northern Affairs Canada – Type B Water Licence
- Workers' Compensation Board (WCB), Mine Health and Safety – Drilling Authorization
- Indian and Northern Affairs Canada – Quarry Permit
- Indian and Northern Affairs Canada – Registration of Fuel Storage Tanks
- Prince of Wales Northern Heritage Centre – Archaeology.

4.6.2 FUTURE DEVELOPMENT

The Gahcho Kué Project is being reviewed and permitted under the Mackenzie Valley Resource Management Act (the Mackenzie Valley Act). A list of the permits that may be required for project development is presented in Table 4.2.

4.7 Environment

4.7.1 BASELINE STUDIES

Baseline studies were ongoing on the Property since 1995. Study area boundaries were established for land, water, air, vegetation, wildlife, fisheries and archaeology.

Archaeological sites identified will be protected; no known site is threatened by the proposed development.

4.7.2 PERMITTING FOR DEVELOPMENT

De Beers, on behalf of GKJV, filed applications with the Mackenzie Valley Land and Water Board (MVLWB) in November 2005 for a Class A Water License (MV2005L20015) and a Type A Land Use Permit (MV2005C0032) to construct a diamond mine at Kennady Lake.

On 1 December 2005, the MVLWB deemed the applications complete and notified the Mackenzie Valley Environmental Impact Review Board (MVEIRB) that it had started a preliminary screening. On 22 December 2005, Environment Canada referred the proposed development to the MVEIRB for an environmental assessment (EA).

Table 4.2: Major Regulatory Permits, Licences & Authorizations Required for Gahcho Kué

Authorization/Permit	Legislation	Agency	Tenure
<i>Planning, Design & Preparation for Environmental Assessment Phase & Environmental Monitoring</i>			
Archaeological Research Permit	NWT Archaeological Resources Act	Prince of Wales Northern Heritage Centre, Department of Education, Culture and Employment, GNWT	Annually as needed for archaeological research during any phase that research is deemed necessary.
Wildlife Research Permit	NWT Wildlife Act	Department of Resources, Wildlife and Economic Development, GNWT	Permit will be needed long-term for each phase of mine life for a wildlife monitoring plan. Permits are issued annually.
Scientific Research License	NWT Research Act	Aurora Research Institute	As needed for Socio-economic and Traditional Knowledge field work and investigations. Licences are issued annually.
Scientific Research Permit	NWT Research Act	Aurora Research Institute	As needed for aquatic and wildlife effects monitoring plans. Permits are issued annually.
Fisheries Research License	Fisheries Act	Fisheries and Oceans Canada	As needed for aquatic and wildlife effects monitoring plans. Permits are issued annually.
<i>Construction/Operation/Closure Phase</i>			
Land Lease License of Occupation	Territorial Lands Act and Regulations Real Property Act	Aboriginal Affairs and Northern Development Canada (AANDC)	Long-term licence needed for project life. Maximum 21 year lease for winter access road then renewal to cover final years.
Mining Lease	Territorial Lands Act Canada Mining Regulations	Mineral and Petroleum Resources Directorate, AANDC	Long-term licence needed for project life. Initially issued for 21 years; renewable for an additional 21 years.
Class A Water License	Mackenzie Valley Resource Management Act Northwest Territories Water Act Northwest Territories Water Regulations	Mackenzie Valley Land and Water Board	Long-term licence needed for project life. Issued in first year of mine for five years; renewable for additional years to cover remaining phases of mine life (Licence tenure in renewals may be variable as dictated by the MVLWB.)

Authorization/Permit	Legislation	Agency	Tenure
Type A Land Use Permit	Mackenzie Valley Resource Management Act and Mackenzie Valley Land Use Regulations	Mackenzie Valley Land and Water Board	Long-term licence needed for project life. Permit generally issued for five years, possibility for extension to seven years with renewal thereafter.
Quarry Permit	Territorial Lands Act and Territorial Quarrying Regulations	MVLWB	Long-term permit needed for use of quarry. Permit to be issued annually.
Operations & Safety Plan Approval	NWT Mine Health and Safety Act NWT Mine Health and Safety Regulations	GNWT, Chief Inspector, Workers Compensation Board	Long-term approval needed for construction and operation phases of mine (approximately 20 years). Approval is granted at start of mine with annual review thereafter.
Section 35(2) Authorization	Fisheries Act	Fisheries and Oceans Canada, Fish Habitat Management	At each stage of renewal of water license or land use permit, if fish habitat is harmfully altered, disrupted, or destroyed.
Water Intake Authorization	Fisheries Act	Fisheries and Oceans Canada, Fish Habitat Management	Long-term authorization needed for all phases of mine until closure is complete.
Approval for Constructing Works in a Navigable Water	Navigable Waters Protection Act	Fisheries and Oceans Canada, Canadian Coast Guard	Long-term authorization needed for all phases of mine until closure is complete.
Explosives Manufacture Explosives Storage Explosives Handling Magazine Permits Permit to Store Detonators	Explosives Act and Regulations NWT Mine Health and Safety Regulations	Department of Natural Resources Canada GNWT, Chief Inspector, Workers Compensation Board.	Long-term authorization needed for all phases of mine until closure is complete.

Note: At the effective date of this report, none of these permits was in hand.

The MVEIRB initiated the EA on 4 January 2006. On 12 June 2006, the MVEIRB concluded that the proposed Project would likely cause significant public concern and ordered that the GKJV conduct an Environmental Impact Review (EIR) for the proposed development pursuant to the Act. The MVEIRB issued its “Reasons for Decision and Report of Environmental Assessment for the De Beers Gahcho Kué Diamond Mine, Kennady Lake, NWT” on 28 June 2006.

On 28 July 2006, GKJV requested that the NWT Supreme Court conduct a judicial review on the MVEIRB’s decision. The Supreme Court heard the application on 22 November 2006 and upheld the MVEIRB’s decision for an EIR process on 2 April 2007. The MVEIRB notified potential parties and the public of the continuation of the EIR process on 20 April 2007.

In May 2007, the MVEIRB released the draft Terms of Reference for the Environmental Impact Statement (EIS) and appointed the Gahcho Kué Environmental Impact Review Panel (the Gahcho Kué Panel). The Gahcho Kué Panel is an independent body consisting of seven members. It is responsible for assessing the potential impacts of the proposed Project. A final Terms of Reference for the EIS was released on 5 October 2007. The GKJV delayed final preparation and filing of the EIS to coordinate the EIS preparation and documentation with the Feasibility Study project development plans. A revised project description was completed in 2010.

Final EIS was partially filed during December 2010, and completed in June 2011. An EIS supplement was filed in April 2012. The Gahcho Kué Panel assessed the proposed project based on the EIS submission and other relevant information. The Gahcho Kué Panel conducted a conformity check of the EIS to determine that the terms of reference were met; conducted a technical review; issued and processed information requests; conducted technical and public hearings; and prepared a recommendation report of the Gahcho Kué Panel. The Panel report was issued July 19, 2013.

The Gahcho Kué Panel’s report made a recommendation to the Minister of Aboriginal Affairs and Northern Development to approve the proposed development under certain conditions. After due consideration, the Minister issued a decision on October 22, 2013; that the proposed development should proceed to permitting phase.

The Project is now in the second licensing phase. GKJV has made applications for the many licenses, permits, and authorizations that fall under federal and territorial jurisdictions (see Table 4.2). The Project will require permits for long-term land tenure through a land lease. The GKJV was issued a Pioneer Land Use Permit (PLUP) on November 29, 2013 to allow for the construction of critical infrastructure and the 2014 winter road. Work is ongoing to install a 252-room camp, airstrip, pads and roads, fuel storage, and other supporting infrastructure under the conditions of the PLUP.

4.7.3 REHABILITATION

GKJV estimates that rehabilitation costs associated with the PLUP and areas that were subject to exploration and drilling programs, is approximately \$11.3 M. A reclamation bond has been posted for this amount.

SECTION 5 ACCESSIBILITY, CLIMATE, LOCAL RESOURCES, INFRASTRUCTURE & PHYSIOGRAPHY

5.1 Site Access

Access to the site is by floatplane in the summer and by aircraft equipped with skis or wheels in the winter. During winter, larger aircraft such as a Dash-7 and Super Hercules L100 Transport can operate from a thickened ice landing strip on the lake. A gravel airstrip will be constructed at the onset of the construction period to provide year round access for similar sized aircraft.

A winter road connects Yellowknife to the Snap Lake, Ekati, and Diavik mines during February and March each year (see Figure 4-1). The road is operated under a Licence of Occupation by the winter road JV Partners who operate the Ekati, Diavik, and Snap Lake mines. The road passes within 70 km of the Gahcho Kué site, at Mackay Lake. A 120 km winter road spur has been established from Mackay Lake to the project site, and was open in 1999, 2001, 2002, 2006, 2013 and 2014. The 120 km winter road spur will be constructed each year to support the mine construction and operation.

5.2 Climate

The climatic data and design criteria for the project site are summarised as follows:

- January (2.5% minimum incidence of occurrence).....-45°C
- July (2.5% maximum incidence of occurrence).....+25°C dry bulb/+16°C wet bulb
- Maximum recorded temperature +31°C
- Minimum recorded temperature-54°C
- Mean temperature.....-9.6°C
- Barometric pressure95.87 kPa
- Maximum wind speed..... 110 km/h
- Average prevailing wind speed 12 km/h
- Prevailing wind direction East
- Wind speed for infiltration..... 48 km/h

Temperature and precipitation characteristics at the site are expected to be close to average conditions recorded at the Yellowknife and Lac de Gras Extended AES climate stations.

5.3 Local Resources & Infrastructure

The Gahcho Kué site is typical of many northern Canadian mining operations that lack local and regional infrastructure such as permanent road access, navigable shipping routes and ports, and external utilities. Therefore, the Gahcho Kué site requires extensive infrastructure to sustain operations, including power generation, sewage and water treatment, personnel accommodation, storage facilities for materials delivered on the limited annual winter ice road, and an aerodrome to provide year-round cargo, food and passenger aircraft access.

The design approach for the Gahcho Kué site infrastructure will incorporate features common to other northern mining developments:

- Permafrost conditions will be considered in foundation designs, especially for settlement-sensitive structures and equipment. Major plant structures will be founded on bedrock and lesser structures on socketed steel pipe piles. The single-storey accommodation facilities and similar trailer units will be erected on a pads consisting of crushed and compacted mine rock.
- The airstrip and apron will be constructed from crushed, screened and compacted layers of mine rock.
- Electric power will be provided by a stand-alone modular diesel generating plant.
- Storage facilities/areas for consumables and spare parts will be sized for one year's supply requirement (e.g., diesel fuel, ammonia nitrate, cement, ferro-silicon, and operating and capital spares).
- Exhaust gasses (waste heat) from diesel generators will be recovered to the maximum practical extent and used for heating the plant site buildings.
- Major buildings, including the process plant, accommodations complex, service complex, and power plant, will be connected by enclosed, heated utilidors so personnel can access these facilities without going outdoors. The utilidors also provide support and routing for utilities such as piping, power, control and communications cables.
- Depending on function, fixed equipment will be located in heated or unheated structures. Personnel safety during construction, operation and maintenance is a prime consideration in plant layout.
- Piping for outdoor water, sewage, and slurry lines will be insulated and heat-traced (as required).
- Construction labour and indirect costs are typically relatively high in this region. Wherever practical, to minimize site erection time, equipment and buildings will be pre-assembled off site and delivered to site as modules or on skids.
- Common support services such as potable water, fire water, and sewage treatment will be provided as stand-alone equipment and systems. Waste generated from operations will be managed on site. Depending on category, wastes will be landfilled, incinerated, or shipped off site for proper disposal at approved facilities.

- Facility layout will accommodate snow clearing.
- Electrical grounding systems will be suitable for permafrost conditions.

5.4 Physiography

The site lies on the edge of the continuous permafrost zone in an area known as the barren lands. The surface is characterised as heath/tundra, with occasional knolls, bedrock outcrops, and localised surface depressions interspersed with lakes. A thin discontinuous cover of organic and mineral soil overlies primarily bedrock, which, occurs typically within a few metres of surface. Some small stands of stunted spruce are found in the area. There are myriad lakes in the area. Kennady Lake, under which the kimberlite pipes lie, is a local headwater lake with a minimal catchment area.

SECTION 6 HISTORY

In the early 1990s, Gahcho Kué, previously known as the Kennady Lake project, was staked by Mountain Province Diamonds. Canamera Geological Ltd. was contracted to conduct the original exploration, which led to the discovery of the 5034 kimberlite pipe in January 1995. A brief history of the project is presented below.

6.1 Historical Timeline

- 1990s: Exploration by Canamera Geological on behalf of Mountain province Mining Inc. and partners. 5034 pipe discovered.
- 1997: Letter agreement entered into with Monopros Limited (now De Beers Canada) in terms of which they could earn a 51% interest in the project. Hearne, Tuzo and Telsa pipes discovered in mid-1997.
- 1998: Mini bulk sampling of 5034, Hearne, Tuzo and Telsa by Monopros. Preliminary scoping study by MRDI (now AMEC).
- 1999: Bulk sampling by large diameter drilling of Hearne, Tuzo and Telsa by Monopros.
- 2000: De Beers Canada conducts Desktop Study.
- 2001: Further resource drilling of 5034, Hearne and Tuzo by De Beers Canada.
- 2002: Joint Venture agreement entered into between Mountain Province (44.1%), De Beers Canada (51%) and Camphor Ventures (4.9%).
- 2003: Technical (pre-feasibility) Study commences.
- 2004/5: Further hydrological, geotechnical design and resource drilling. Engineering and environmental baseline studies completed.
- 2005: Completion of the C\$25 million Technical Study. Commencement of the C\$38.5 million advanced Exploration Program and filing of applications for construction and operating permits.
- 2006: Mountain Province acquires controlling interest in Camphor Ventures. Independent valuation of Gahcho Kué diamonds completed. Tuzo and 5034 North Lobe delineation and geotechnical drilling completed.
- 2007: Mountain Province acquires 100% of Camphor Ventures thereby increasing interest in Gahcho Kué to 49%. Core drilling program completed at Tuzo to upgrade the Tuzo resource. Infill drilling program completed at the 5034 kimberlite. 5034 North Lobe bulk sampling program completed.

- 2008: Tuzo bulk sampling program completed. 25.14 carat gem quality diamond recovered from Tuzo drill program. Updated independent valuation completed; actual price per carat of bulk sample diamonds recovered increases 63% to \$135 per carat.
- 2009: Updated mineral resource statement completed. Revised and restated joint venture agreement concluded between Mountain Province and De Beers.
- 2010: Feasibility Study completed. Updated EIS under preparation for filing in December.
- 2011: Environmental impact review commences. Updated independent diamond valuation completed (\$185/carat). Feasibility study approved by JV. Decision to build approved by JV partners. Tuzo Deep resource drilling commences.
- 2012: Environmental impact review continues. JV approves initial C\$32 million capital budget for early mobilization. Updated independent valuation completed (\$186 per carat). Public hearings under environmental impact review concluded.
- 2013: Environmental impact review public record closes. Supplies to mine site commence on winter road.
- 2013: MVEIRB recommends project.
- 2013: 22nd October, Ministerial approval received for the Gahcho Kué Project.
- 2013: November 29, 2013; Pioneer Land Use Permit Issued.
- 2014: Winter Road installed and 634 truckloads of material delivered to site.
- 2014: Revised and Updated Gahcho Kué 2014 Feasibility Study Report completed.

6.2 Historical Mineral Resource Estimations

The mineral resource estimate for the property was compiled by AMEC (2009) and Mineral Services (2013). JDS has included information from these Reports in the Sections 7 through 14 below. In the opinion of JDS, the mineral resource estimates are adequate to support a feasibility study for the Gahcho Kué project.

SECTION 7 GEOLOGICAL SETTING & MINERALIZATION

7.1 Geological Setting

7.1.1 REGIONAL GEOLOGY

The Gahcho Kué kimberlite cluster occurs in the southeast Slave Craton, a small Achaean nucleus within the North American Craton (Figure 7-1), which contains rocks ranging in age from 4.05 Ga to 2.55 Ga (Bleeker et al., 1999). The oldest rocks of the Slave Craton are small remnants of felsic granites and gneisses (2.8 Ga to 3.2 Ga; Beals, 1994), and the Acasta Gneisses (3.6 to 4.0 Ga; Bowring et al., 1989) located in the western part of the craton. Several supracrustal series (metasedimentary rocks with less common metavolcanic rocks) crop out in the central and eastern parts of the Slave Craton, forming the Yellowknife Supergroup (circa 2.7 Ga). The Yellowknife Supergroup is intruded by an extensive series of pre- to post-deformational (2.69 to 2.60 Ga) felsic plutons.

The eastern portions of the Slave Craton are Late Achaean island-arc complexes (magmatic arcs and accretionary prisms) accreted to the margin of an older continental fragment to the west (Griffin et al., 1999).

Several swarms of Early-Mid Proterozoic (2.0-2.3 Ga; see LeCheminant et al., 1995) basaltic dykes occur in the Lac de Gras area. A suggested source for the Lac de Gras dyke swarm is beneath the Kilohigok Basin.

The north–northwest trending Mackenzie dyke swarm (1.27 Ga; LeCheminant and Heaman, 1989) extends over 2,300 km from a focus, interpreted as a plume head (Fahrig, 1987), and located west of Victoria Island.

The kimberlite intrusions are of Cambrian age (approximately 540 Ma).

Figure 7-1: Regional Setting, Gahcho Kué Kimberlite Cluster

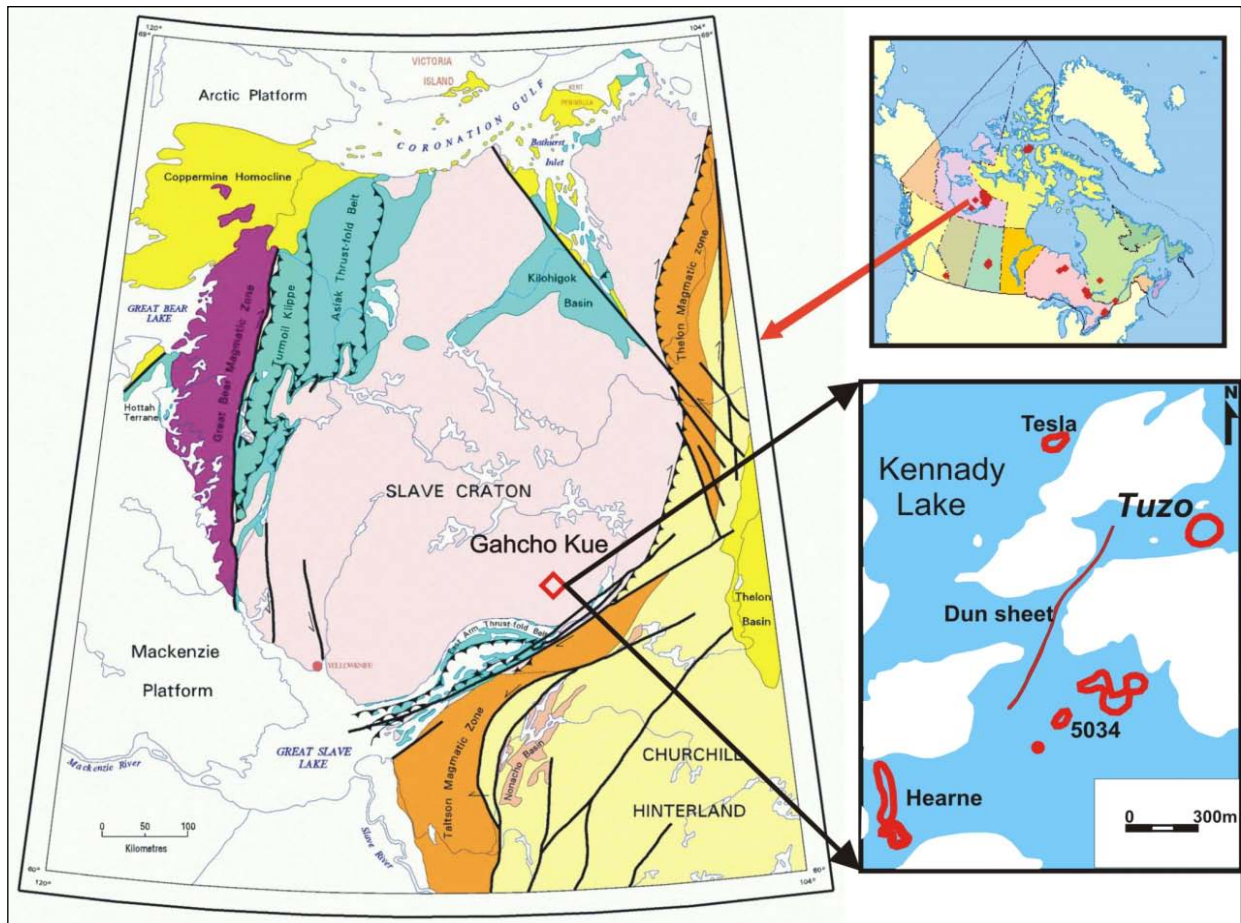

Note: Red diamonds on the plan map of Canada represent a number of other kimberlite occurrences in Canada. The inset shows the relationship between the individual kimberlites that comprise the Gahcho Kué cluster; Dun = Dunn in this Report. Figure from Caro and Kopylova (2004).

7.1.2 PROJECT GEOLOGY

7.1.2.1 BASEMENT

Basement lithologies mapped from limited areas of outcrop in a 16 km² area surrounding the Gahcho Kué cluster include granite, granitic gneiss, minor granodiorite, and diorite that have undergone regional amphibolite-facies metamorphism retrograded to greenschist facies (Baker, 1998). The most common rock type, granite, varies from a medium-coarse grained, equigranular facies to highly foliated granitic gneiss.

Two distinct northwest to north–northwest-trending, linear, magnetic highs in the eastern quadrant are interpreted to be part of the regional Mackenzie diabase dyke swarm. Two east–northeast-trending diabase dykes were identified from linear aerial photo-features occurring south of Kennady Lake and proximal to the Tesla kimberlite. These dykes can be traced in outcrop but do not have strong magnetic expression. They are considered to belong to the Mallay dyke swarm by Baker (1998) and to predate the interpreted Mackenzie dykes.

7.1.2.2 QUATERNARY

The Gahcho Kué area was glaciated repeatedly during the Pleistocene Epoch, most recently by the Laurentian ice sheet. The Laurentian ice sheet began to recede 18,000 years ago, and the ice front retreated past the Gahcho Kué project area between 9,000 and 9,500 years ago (Dyke and Prest, 1987). However, there is no stratigraphic evidence that represents deposits from previous glaciations; the Quaternary geology of the Gahcho Kué area appears to be related only to the last glacial event, the Wisconsinian glaciation (Hardy, 1997). Glacial-related sedimentation is quite thin, with only scarce patches of till blanket and large fluvioglacial outwash fans (Hardy, 1997).

Till veneer, till blanket, and outwash sediments characterize the Quaternary deposits in the Gahcho Kué area. The areas of till blanket contain abundant mud boils and no bedrock exposure. Areas of level sands and reworked till are classified as outwash sediments. Till veneer and till blanket cover most of the area except for small areas to the east of the campsite; outwash sediments occur west of Kennady Lake. Outwash sediments and a large esker that extends along a portion of the southern edge of the mapped area dominate the area south of Kennady Lake.

The stratigraphic record overlying the till is younger than the last glaciation and is composed mainly of pro-glacial sediments (glaciofluvial and glaciolacustrine deposits). As the Gahcho Kué area occurs over a relatively flat terrain, many swamps, ponds, and peat deposits are present (Hardy, 1997).

7.1.2.3 STRUCTURAL SETTING

Granite–gneiss terrane intruded by a series of dykes (Figure 7-2) characterizes the Gahcho Kué area. There are several granitic intrusions surrounded predominantly by gneisses; the gneisses display a clear structural pattern of being metamorphosed by the granitic intrusions. Along the eastern edge of the area, a marked geological boundary is interpreted to represent contact with meta-sediments that extend eastwards. The central portion is a structurally complex zone of folding and possible shears.

There are several groups of demagnetised lineaments with weak, negative magnetic expression; these demagnetised lineaments could be dykes or demagnetised country rock resulting from dyke intrusion or faulting. They are grouped as:

- a regular, pervasive northeast-trending set
- a regular, pervasive northwest-trending set
- an east–west-trending set in the south of the area.

Figure 7-2: Litho-structural Interpretation of the Gahcho Kué Area

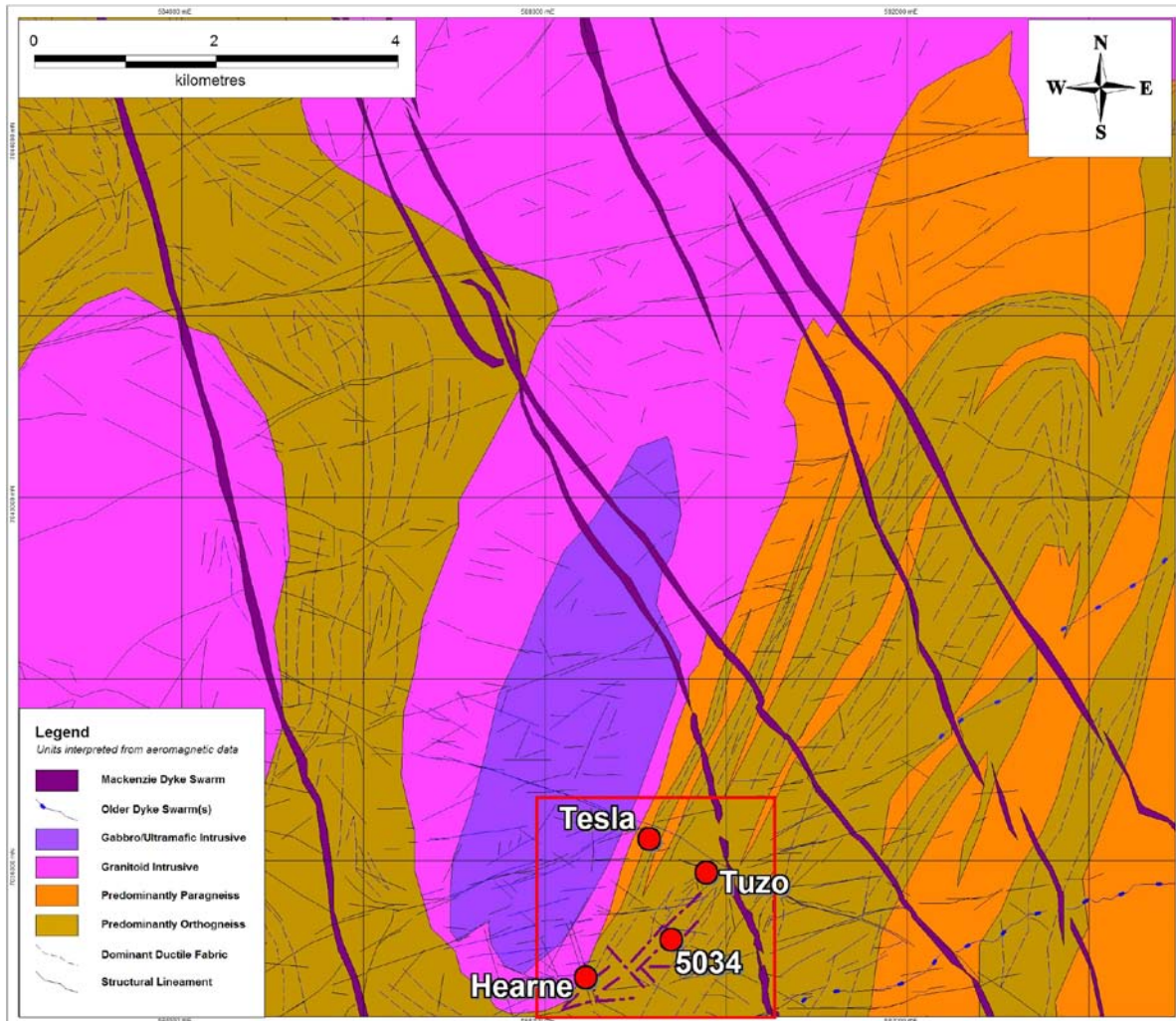

Note: Major first order structures trend northeast–southwest, and are parallel to the circa 2.0 Ga to 1.8 Ga Great Slave Shear Zone; second order (often younger) structures trend primarily northwest–southeast. Figure from SRK (2004).

The 5034, Hearne, Tuzo, and Tesla kimberlites all occur at the eastern edge of an interpreted south-closing fold-nose that has developed a radial fold-nose cleavage. The apparent south-closing fold is interpreted to open to the north–northeast; the dip direction is not known. The core of the fold is composed of granite and minor granodiorite. Northeast-trending axial-planar foliation associated with the fold is developed in gneiss.

7.1.3 KIMBERLITE GEOLOGY

7.1.3.1 KIMBERLITE TYPES

Tuffisitic Kimberlite (TK)

Tuffisitic kimberlite (TK) is olive green to light brown in colour. These rocks are relatively soft and can swell on contact with water because of the presence of hygroscopic clay minerals. The TK drill cores are characterised by matrix-supported magmaclastic breccia textures. Common fresh, typically pink-coloured, granitoid xenoliths vary in abundance from 30% to 95% and are as large as 5 m. Xenocrysts of country rock are common and are often shard-like in shape. TK contains two generations of olivine present as macrocrysts and phenocrysts, which are completely pseudomorphed by serpentine. Pelletal lapilli are common; these typically consist of thin selvages of kimberlite, which rim most of the olivines, xenoliths and xenocrysts. Altered groundmass minerals can be identified within the selvages. The matrix between the pelletal lapilli consists of common serpentine and clays. Primary carbonate is not present. In thin section, microlites, which include clinopyroxene, are common. Mantle xenoliths are extremely difficult to identify within the core due to alteration.

Transitional Tuffisitic Kimberlite (TKt)

Rocks classified as transitional tuffisitic kimberlite (TKt) are broadly similar to TK but are more competent and darker in colour. The TKt rocks have a uniform olivine distribution but the breccia matrix displays inhomogeneous textures dominated by magmaclastic textures or pelletal lapilli. In thin section, clinopyroxene microlites are present; however, they are slightly coarser grained than those within the TK rocks. These TK-like areas are closely intermixed with less common small patches that possess magmatic textures. Country rock xenoliths are less common in TKt than in TK and show greater reaction to the host kimberlite. Xenoliths often have a green colour and are more difficult to distinguish within the kimberlite matrix. Olivine macrocrysts and phenocrysts are completely altered to serpentine.

Transitional Hypabyssal Kimberlite (HKt)

Rocks classified as transitional hypabyssal kimberlite (HKt) are broadly similar to the HK rocks but are characterised by inhomogeneous textures dominated by a magmatic groundmass with less common patches of magmaclastic kimberlite. These rocks are dark in colour and competent. The granitoid xenoliths show a degree of reaction with the host kimberlite that is intermediate between HK and TKt and are typically dark green to black in colour. Olivine macrocrysts and phenocrysts are completely pseudomorphed by serpentine. Groundmass minerals include phlogopite, spinel, carbonate, serpentine and perovskite. In thin section, clinopyroxene is common within the groundmass and is much coarser grained than the microlites present within TK and TKt rocks. Such clinopyroxene is absent within HK.

Hypabyssal Kimberlite (HK)

Hypabyssal kimberlite (HK) is mainly fresh, competent, black to dark green, and characterised by uniform macrocrystic textures. The rocks are composed of two generations of olivine consisting of

anhedral, medium-grained, often fresh, olivine macrocrysts, and smaller subhedral to euhedral olivine phenocrysts. The well-crystallised groundmass consists of monticellite, phlogopite, spinel, primary carbonate, serpentine, and perovskite. Mantle xenocrysts, in addition to olivine macrocrysts, include rare garnet and clinopyroxene. Ilmenite is not present. Rare mantle xenoliths consist of garnet lherzolites and eclogites. Country rock xenoliths are predominantly granitoids exhibiting extensive reaction to the host kimberlite, and these xenoliths range in colour from black to white. In areas where significant digestion of granitic country rock xenoliths has occurred, the groundmass is characterised by common phlogopite and/or clinopyroxene reflected in a patchy colouration of the rocks.

7.1.3.2 COUNTRY ROCKS

The country rock contacts along the margins of the pipes are generally variable and broadly correlate with the textural variety of kimberlite present within the pipes. The country rock contacts can be grouped broadly into five main types based on geology:

- sharp contact zones
- brecciated contact zones
- chemically-altered contact zones
- chemically-altered and disaggregated contact zones
- thermally metamorphosed contact zones.

Sharp Contact Zones

Present between kimberlite and country rock, these are characterised by minimal broken cores or altered country rock surrounding the pipe. Sharp contacts are associated with all textural varieties of kimberlite present within the pipes.

Brecciated Contact Zones

Brecciated contact zones are characterised by fractured country rocks that do not contain any kimberlitic component. The variable fragment sizes and shapes range between 0.5 mm to 15 cm. In general, the brecciated zones can be subdivided into two main groups: massive brecciated zones (MBZ) and pulverised brecciated zones (PBZ).

MBZ consists of coarser fragments typically greater than 2 cm in diameter. These zones are often associated with pre-existing joints. The fragments within these zones are typically loose and have not been cemented. The distribution and extent of these broken zones is highly variable and generally increases in intensity as the pipe contact is approached. However, at a distance from the pipe contact, there are contacts without brecciated zones directly adjacent to contacts with brecciated zones. This apparent haphazard distribution of the brecciated zones may be related to the interconnectedness of the country rock joints. The broken country rock fragments can often be fitted back together, with no evidence of particle movement.

PBZ consists of a mixture of larger particles 2 cm to 15 cm in diameter with a matrix composed of finely pulverised country rock < 2 mm in diameter. These breccias are typically cemented. The PBZ can be either clast or matrix supported, and there is often evidence of particle movement. The proportion of fine pulverised material present within these zones is highly variable. Often the larger fragments contain smooth edges and show slight alteration or bleaching along the margins. The PBZ zones are not as common as the MBZ. These breccia zones are interpreted by GKJV to be related to pre-conditioning processes in the early emplacement of the kimberlite. Once the kimberlite has breached the surface, it is thought that the subsequent explosion and violent degassing of the magma column likely incorporated the weak brecciated zones into the pipe. Large xenoliths of this material are present within the Tuzo Pipe.

Chemically-altered Contact Zones

These are characterised by typically minor (< 5 cm) zones of alteration along joint surfaces without significant disaggregation. The intensity of this alteration is variable; however, this decreases in intensity with increasing distance from the pipe contact. Chemically altered contact zones are most often developed in areas around HK. These zones can also contain brecciated country rock. The altered zones typically are pale yellow in contrast to the pink granitoids. These areas can be porous due to the removal of quartz.

Chemically-altered & Disaggregated Contact Zones

These zones are considerably weaker and more extensive than the chemically altered contact zones where present. These areas are characterised by typically extensive chemical alteration that, in extreme cases, can result in extensive disaggregation of the country rock. These zones are also characterised by minor brecciation, but without evidence of transport or cementation. This type of contact zone is most extensively developed in areas around HK and, in particular, within the granite cap over the 5034 North lobe. The most extensive zones are present over the thicker intersections of kimberlite. The altered zones consist of a brittle core that appears bleached (particularly along joints). Feldspars are typically orange in appearance and in thin section appear sericitised. Chlorite and dolomite can be present along joint surfaces.

Thermally Metamorphosed Contact Zones

These zones are only associated with hot contacts related to HK, and are typically less than 50 cm wide. Weakest adjacent to the kimberlite, the country rock displays less reaction to the intruding kimberlite with increasing distance from the contact. The country rock within these zones is often grey or white in colour in contrast to the typically pink granitoids, and can contain significant green serpentine as well as carbonate veins.

7.1.3.3 COUNTRY ROCK XENOLITHS

Country rock xenoliths within the Gahcho Kué kimberlite pipes are dominated by granitoid xenoliths with lesser diabase, gneiss, and rare volcanic rocks. No sedimentary-rock xenoliths are present.

Xenolith contents of the kimberlites are variable, particularly in the TK units. For logging purposes, the following terms are used to describe the kimberlite texture. K = kimberlite:

- B = breccia
- m = micro- breccia.

The following terms are used in indicated xenolith abundance.

- K: < 15% (not a breccia)
- KB: 15% to 50% (breccia)
- KBB: 50% to 75% (breccia)
- KBBB: >75% (breccia)
- KmB: >15% xenoliths 5 mm to 10 mm (microbreccia).

7.1.3.4 GAHCHO KUÉ KIMBERLITES

The main Gahcho Kué kimberlite cluster comprises four pipes: Hearne, 5034, Tuzo, and Tesla. The Hearne Pipe, most of the 5034 Pipe, and the Tuzo and Tesla pipes occur under Kennady Lake (refer to Figure 7-2), which has an average depth of 8 m. The kimberlites may represent the oldest known occurrences of kimberlite on the Slave Craton. The 5034 kimberlite was Rb–Sr isotopically dated (phlogopite) as Middle Cambrian (542.2 ± 2.6 Ma: Heaman et al., 2003). Hetman et al. (2004) suggest similar ages for the Tuzo, Tesla and Hearne kimberlites based on Ar⁴⁰–Ar³⁹ dates on phlogopite that are 542 ± 6 , 531 ± 6 and 534 ± 11 Ma, respectively.

Gahcho Kué kimberlites are overlain by varying thickness of glacial boulder outwash and lake sediments (averaging 10 m thick), and have a combined water and sediment cover as much as 25 m thick.

The pipes are steep-sided and were formed by the intrusion of several distinct phases of kimberlite in which the textures vary from HK to diatrema-facies TK. TK displays many diagnostic features including abundant unaltered country rock xenoliths, pelletal lapilli, serpentinised olivines and a matrix composed of microlitic phlogopite and serpentine without carbonate. HK contains common fresh olivine set in a groundmass composed of monticellite, phlogopite, perovskite, serpentine and carbonate. A number of separate phases of kimberlite display a magmatic textural gradation from TK to HK, which are characterised by a decrease in the proportion of pelletal lapilli and country rock xenoliths, and an increase in groundmass crystallinity, proportion of fresh olivine, and the degree of xenolith digestion (Hetman et al., 2004). Characteristics of each pipe are summarised in Table 7.1.

Table 7.1: Characteristics of Gahcho Kué Kimberlites

Pipe	Characteristics
Hearne	Transitional diatreme and hypabyssal root zone
5034	Irregular hypabyssal root zone
Tesla	Transitional diatreme and hypabyssal root zone
Tuzo	Deeper part of less complex diatreme zone

7.1.3.5 HEARNE KIMBERLITE

Two bodies comprise the Hearne kimberlite, Hearne South and Hearne North (Figure 7-4). The bodies have smooth, steep-sided walls, and cover an area of about 1.5 ha. Hearne South is a roughly circular pipe, whereas Hearne North is a narrow, elongate pipe trending north–south. The pipes may join at depth. The width of country rock between the two bodies varies from a minimum of approximately 20 m at the sub-crop to approximately 70 m at depth. Hearne North measures a maximum of 250 m x 50 m north–south. Hearne South has a dimension of about 80 m x 90 m at surface. Hearne South is dominantly infilled with TK, and Hearne North is infilled with approximately equal amounts of HK and TK.

The present pipe geological model for Hearne South extends to 121 masl; however there is no drill information below 225 masl; this area of the Hearne kimberlite is referred to as Hearne South undefined. At Hearne North, the pipe narrows to less than 10 m wide in the centre of the body at approximately 130 m below lake-surface. There is also evidence at the north and south ends of the body that the pipe extends below 115 masl.

The distance from the south end of Hearne to Tuzo is about 2 km in Figure 7-3. In Figure 7-4, Hearne South is the pipe-like body on left of image, Hearne North on right.

Figure 7-3: 3D View of Gahcho Kué Kimberlite Bodies Looking Northwest

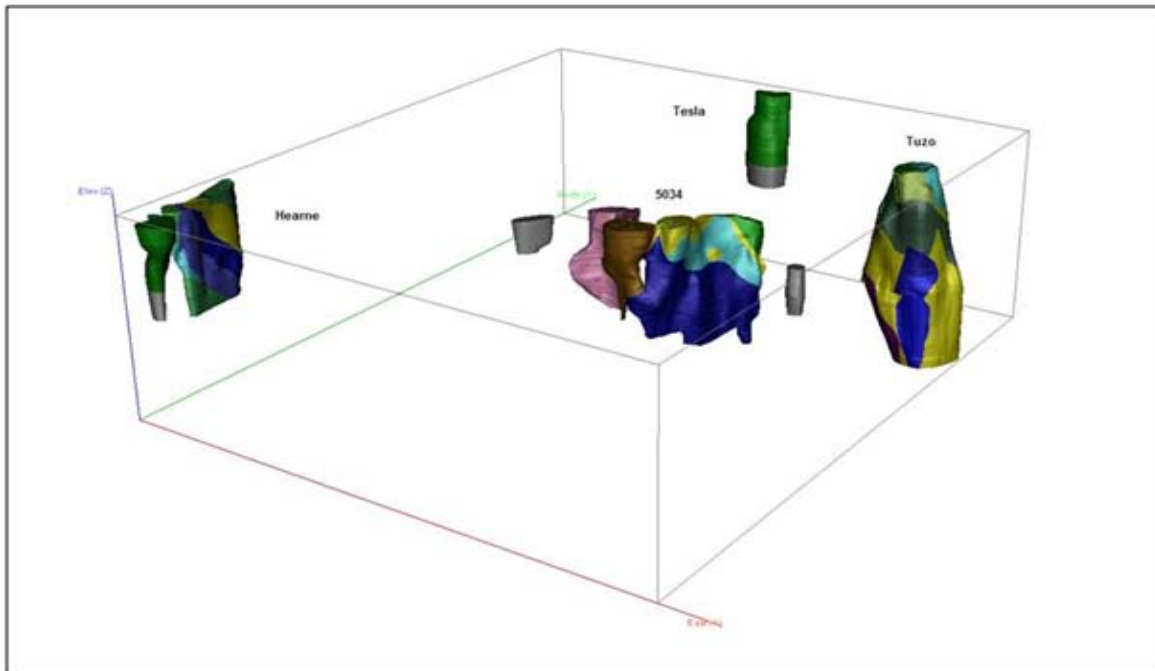
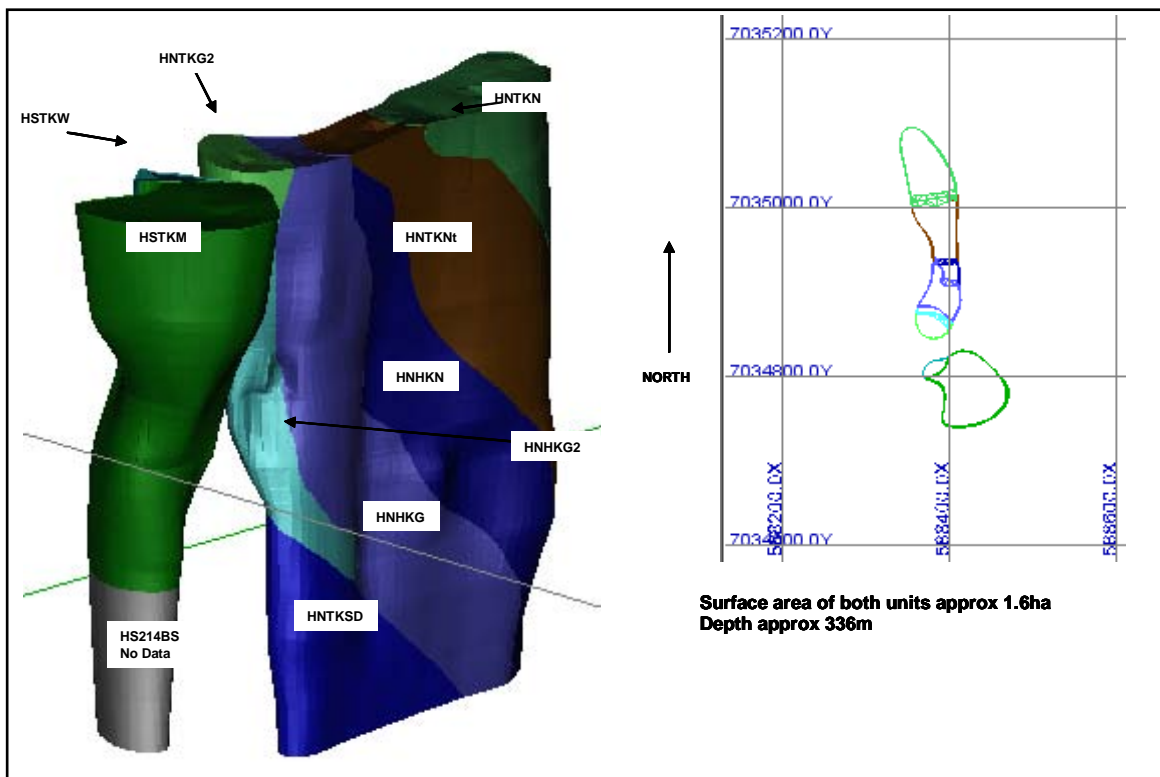

Figure 7-4: Section View of Hearne Looking Northwest



7.1.3.6 5034 KIMBERLITE

The 5034 kimberlite is a highly irregularly-shaped pipe and dyke complex, which is comparable to kimberlite root zones elsewhere and has a surface area of approximately 2.1 ha (West, Centre and East Lobe; Figure 7-5).

The 5034 kimberlite is modelled as a semi-continuous occurrence composed of five discrete kimberlite bodies, three of which are modelled as joined at the subcrop to form one main continuous body, with two small outlying satellite pipes (Figure 7-5).

Figure 7-5: 3D View of 5034 Looking Northwest

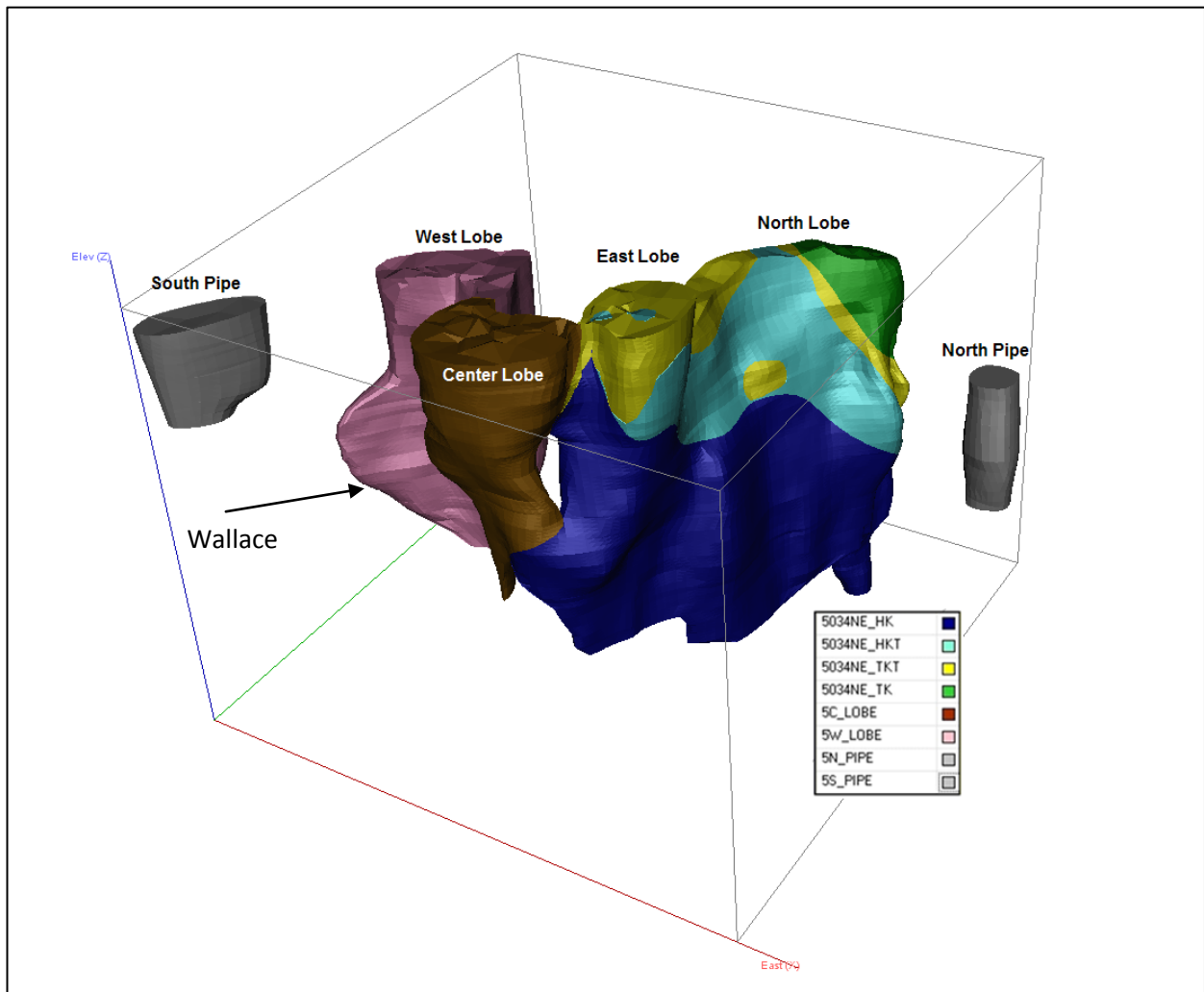

The five modelled kimberlite bodies are referred to as follows:

- 5034 South Pipe
- 5034 “Main” West Lobe
- 5034 “Main” Centre Lobe
- 5034 “Main” North-East Lobe (i.e., East Lobe and North Lobe)
- 5034 North Pipe.

The main part of the 5034 occurrence that reaches the surface occurs under Kennady Lake and can be divided into three lobes: West, Centre and East. These three lobes are joined at the surface, but separate at depth. The Centre and East lobes are modelled separately at shallow depth, but rejoin at greater depth producing what appears to be a window of granite within the kimberlite. The East and North lobes are joined at depth, geologically continuous, and are collectively referred to as the North-East Lobe. The surface measurements of the three lobes of the 5034 Main Pipe are approximately as follows:

- West Lobe – 125 m x 45 m
- Centre Lobe – 125 m x 80 m
- East Lobe – 85 m x 65 m.

The northern portion of the 5034 North-East lobe, the North Lobe, is blind, and occurs under 60 m to 90 m of country rock cap. Approximately half of this northern lobe lies below the lakebed and half beneath the main peninsula. The blind northern portion of the 5034 North-East Lobe measures 240 m long and varies from approximately 20 to 50 m wide, averaging 30 m wide. A combined internal geology model is developed for the 5034 North-East Lobes. There are four major kimberlite types, three of which occur across both lobes (refer to Figure 7-5).

The modelled 5034 kimberlite occurrence includes two small satellite intrusions, the 5034 South Pipe and the 5034 North Pipe, which are modelled separately from the main 5034 body due to very limited information on these bodies.

Some areas of the 5034 Pipe contacts remain poorly defined. 5034 South Pipe extends as deep as 305 masl, the maximum depth of the available information. The 5034 South Pipe and the 5034 West Lobe appear to be connected by a complex tuffisitic kimberlite breccia (“TKBBB”). Interpretation of drilling data suggests.

Based on petrographic observations and whole-rock geochemical data, a systematic arrangement of lithofacies types was recognised. HK textured kimberlites are located in deeper levels of the pipe, followed by transitional textured kimberlites (HKt and TKt) until fragmental textured kimberlites (TK) dominate in the uppermost portions of the pipe. TK and TKt textured kimberlite are present in the West and North-East lobes. The Centre Lobe is dominated by HK.

Four main textural kimberlite units are identified in the 5034 North Lobe: TK, TKt, HKt, and HK (Kryvoshlyk, 2006). The spatial distribution of those rock varieties creates an antiformal structure located approximately in the geographical centre of the lobe. The most important rock types in the North Lobe are HK and HKt, which are present in the deeper levels of the lobe and comprise the saddle of the antiform. TK and TKt rock types are mainly present in the shallow levels of the flanks in the North and South of the antiform and are overlying the HK units. A specific unit, the so-called “Orange Marker,” is identified in thin sections throughout the North Lobe. A selected suite of kimberlite rocks from the East and North Lobe were examined and the samples were concluded to show well-developed petrological similarities suggesting a close genetic relationship of the two lobes (Kryvoshlyk, 2007).

Kryvoshlyk (2008) showed that the North-East and West lobes have an overall layered internal structure, comprising gradual kimberlite textural changes from coherent HK at depth to fragmental TK at shallower levels. Transitional rocks in between these end member coherent or fragmental rocks are either called HKt or TKt, depending on their textural association. In contrast to the layered structure of most lobes, the Centre Lobe is composed exclusively of HK, which could not be subdivided with available petrological or geochemical data despite the variable diamond counts in this lobe. The HK found in all four lobes is geochemically and petrologically similar, suggesting a close genetic relationship between all four lobes.

Kryvoshlyk (2008) concluded that the quality of the geological model is strongly dependent on the data density (drill core and reference samples) and on sample collection protocols. The highest data density is present in North-East Lobe, which results in a relatively high-confidence model. The West and Centre lobes have a lower data density (both with respect to drill density and number of reference samples) and rather poor sample control (difficulties connecting micro-diamond and heavy mineral samples with geology). It is therefore not possible to produce a high-confidence geological model for West Lobe or to explain the diamond data variability in Centre Lobe without additional data. The Centre Lobe is composed almost entirely of HK, and minor HKt. With the dataset available in 2008, the HK rock types are petrographically and geochemically indistinguishable; thus, Kryvoshlyk (2008) recommended that they be modelled as one unit. The West Lobe is to some extent similar to the North-East Lobe in that the sequence HK–HKt–TKt is present, and these rocks are petrologically similar. The West Lobe is divided into three petrological units, a Main Lower HK unit, a Main Upper HKt unit, and a Secondary Upper TKt unit; however, significant uncertainty is associated with the contacts between those units, and the resource model considers the pipe to be undifferentiated kimberlite.

7.1.3.7 TUZO KIMBERLITE

In the section below, the key findings from two studies (Seghedi and Maicher, 2007; Mann, 2013) conducted on the geology of Tuzo by the DBC Kimberlite Petrology Unit (KPU) on behalf of the GKJV are summarised. More detailed descriptions and presentations of data on the geology of Tuzo are available in these reports. Seghedi and Maicher (2007) presented new petrographical, geochemical and micro-diamond data for Tuzo Pipe with the purpose of developing a 3D internal geological model. The 2007 study refined the previous internal geology model (Hetman et al., 2003; and Hetman et al.,

2004) and reassessed the diamond distribution model. The overall surface area of the Tuzo Pipe is about 1.2 ha, which is covered by as much as 25 m of water of and glacial overburden. The kimberlite body comprises various fragmental and coherent kimberlites, and it contains abundant inclusions of the surrounding granitic country rock. The 2007 drill program improved the definition of the shape of the pipe, which is unusual as it widens towards depth from 125 m in diameter near the surface to about 225 m at 300 m depth. Tuzo geology model commences about 25 m below lake level (lake level 420.9 masl). Information obtained from the 2011/2012 Tuzo Deep program enabled extension of the Tuzo pipe model from 360 mbs to 564 mbs, establishing that below ~330 mbs, the pipe maintains an ellipsoidal outline oriented northeast to southwest, but that the pipe dimensions gradually narrow with depth. The surface area of the pipe at the base of the model is approximately 1.3 ha (~175 m by 115 m). The 2013 update to the 2009 Tuzo pipe model is illustrated in Figure 7-6.

Figure 7-6: Profile of 3D Geological Pipe Shell Models from 2009 (left) & 2013 (right)

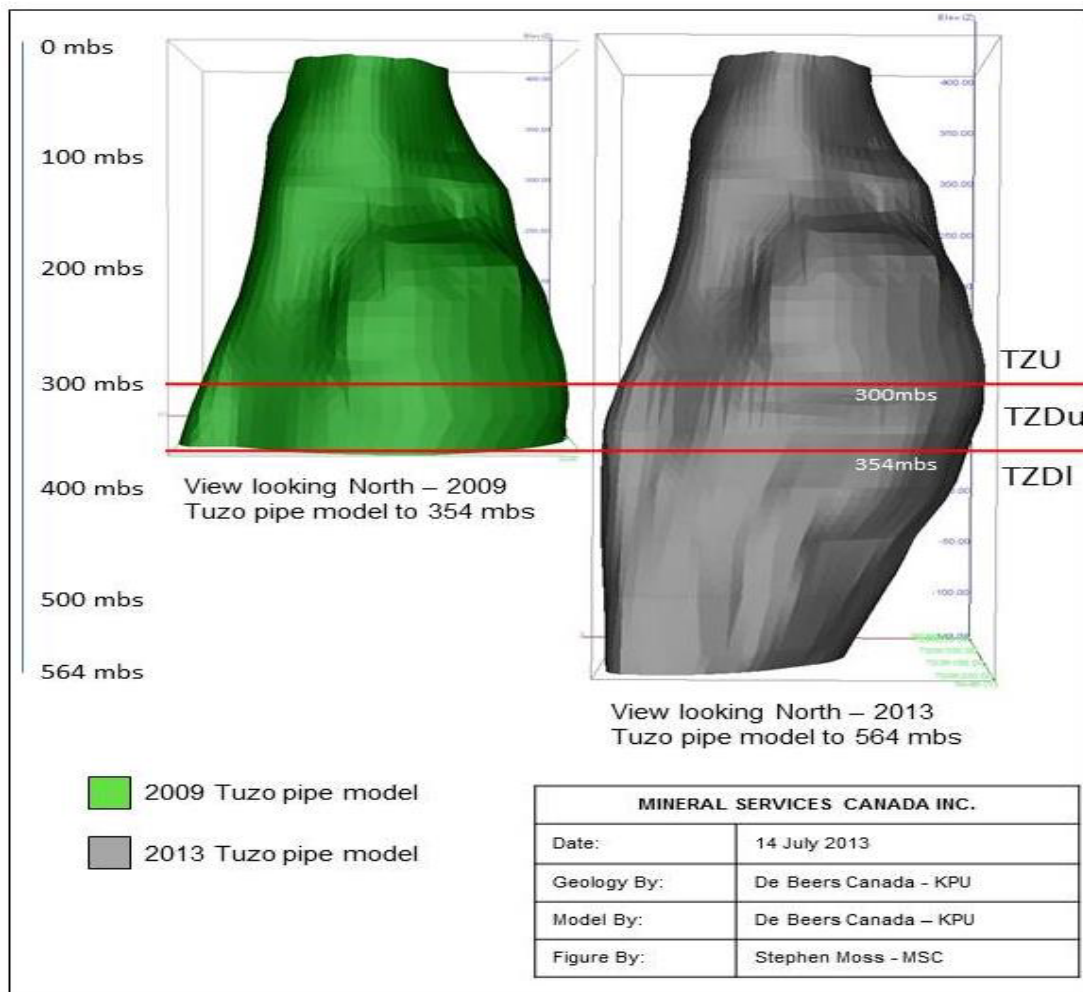

Note: The Tuzo Deep portion of the Tuzo kimberlite begins at 360 mbs; not at 354 mbs as indicated on the in Figure 7-6 ; 354 mbs is mid-bench, 360 mbs is the lowest extent of the bench.

Five (5) major textural sub-types of kimberlite (rock types) have been observed and logged in drill core from Tuzo. These types form a broad sequence with depth in the pipe as follows (from top to bottom): TK (tuffisitic kimberlite); TK-Tkt (TK transitional to Tkt); Tkt (TK transitional to HK); HKt (HK transitional to TK) and HK (hypabyssal kimberlite). Additional rock types defined and logged in Tuzo include country-rock breccia with kimberlite (CRX bx w/K); country-rock xenoliths (CRX) and an Epiclastic Unit (EU). The latter comprises short intersections too widely distributed for it to have a significant impact on the Resource Classification and, as part of the Tuzo Deep geology model update, has been incorporated into the modelled country-rock breccia unit (Mann, 2013). The models for Tuzo Upper are unchanged from those used for the 2010 Feasibility Study (Johnson, et al., 2010). As part of the Tuzo Deep study, the model for upper portion of Tuzo Deep (Tuzo Deep Upper; 300 to 360 mbs) was updated and a new model generated for lower portion of Tuzo Deep (Tuzo Deep Lower; 360 to 564 mbs)(Chuchra, 2013). The updated Tuzo Deep geological model includes two kimberlite domains (Tkt and HK), country-rock breccia with minor kimberlite (CRXBX), the extension of the granite raft into Tuzo Deep Upper (RAFT_TZDu), and two large isolated blocks of granite (CRX1 and CRX2). The Tkt and HK domains in Tuzo Deep correspond with the Tkt2 and HK in the upper reaches of the kimberlite.

Seghedi and Maicher (2007) reported that the internal geology of Tuzo is very complex. Abundant country rock xenoliths, ranging from a few millimetres in diameter up to blocks several tens of metres in size, are hosted within the pipe. The highest degree of dilution is concentrated along a belt-like zone at about 120 to 200 m depth and under the roof of the widening pipe. The distribution of lithologies follows, very generally, a trend from top to bottom: TK, TK-Tkt, and Tkt as well as HKt+Tkt, HKt, and HK. On a more detailed scale, however, the different lithologies occur as several metres to tens of metre thick intercalated sections. Contacts in between the kimberlite rock types are mostly gradual. The lithological units show limited horizontal extent. Instead, they appear steeply to sub-vertically oriented, which gives the Gemcom® internal geology model a rugged shape. Volcanological evidence for mixing and mingling processes combined with the general facies architecture strongly suggest the occurrence of multiple eruptive events that modified the pipe infill extensively.

Seghedi and Maicher (2007) stated that the geochemical signature of the lithologies is strongly influenced by the variable but generally high degree of country rock contamination. Fragmental kimberlite units are geochemically and petrologically very similar, suggesting a close genetic relationship. However, the coherent kimberlite types HK and HKt are slightly discordant to the geochemical trend defined by the fragmental kimberlites,

In its shallow levels the pipe contains a zone that is characterised by a higher diamond grade and lower dilution compared to the surrounding fragmental rock units. This High Grade zone (TZ-TKTh) was originally identified in 1998 from large diameter drilling (LDD) data due to a zone of higher macro-diamond grade (Williamson and Hetman, 1998).

In the geological model developed by Seghedi and Maicher (2007) the Tkt_1 and TK-Tkt_1 model codes form a low dilution zone that includes the pre-2007 high-grade unit. The High Grade zone shows considerable internal inhomogeneities and a high similarity to neighbouring fragmental units (TK and

TK-TKt_2) with respect to many petrographical parameters as well as its mineralogy, whole rock chemistry and micro-diamond (stone counts and size frequency distribution) data. Differences are the generally lower degree of dilution and a higher-grade.

Groundmass spinel chemistry demonstrates that the majority of the TKt, HKt and HK units are of the same magma batch suggesting a voluminous, rapid emplacement. The Tuzo pipe formation begins with the emplacement of a fragmental kimberlite (initially a TK) which is soon after intruded by a coherent magma, the HK. These texturally different kimberlites are still of the same magma batch, only the fragmentation behaviour of the magma changed during emplacement likely due to external factors, such as the interaction of the first intruding kimberlite with ground water leading to magma fragmentation. The depletion of ground water supply leads to non-fragmental emplacement of kimberlite into earlier fragmented tephra. The intrusive kimberlite forms a massive pillar along the eastern margin of Tuzo Deep and has a complex interface with the hosting fragmental kimberlite tephra. Close to the kimberlite intrusion, the interface is defined by an abundance of irregular dykes and veinlets, as well as spalling and agglutination of magma droplets, which intrude and inject the hosting tephra to form a complex peperite network of coherent and fragmental textured rocks. In addition, the intrusion of low viscosity kimberlite melt into the porous tephra framework in wide areas enhances the generation of coherent-looking rocks at this interface. The resulting rock type is a transitional hypabyssal kimberlite that has a mostly coherent appearance with local patches of the original fragmental nature of the host rock. Further from the intrusive coherent kimberlite, the influence of the intruding HK becomes less apparent and the original fragmental texture of the host tephra prevails – a TKt is generated. The granite country rock breccia with kimberlite matrix is interpreted as a contact breccia eroded from the weakened pipe wall during the eruption (Mann, 2013).

The investigation proves compelling evidence 1) that the TKt unit identified in Tuzo Indicated is the same TKt unit identified in Tuzo Deep and 2) the HKt and HK units observed in Tuzo Deep are from the same magma batch as the TKt. The geology is complex and integration of core logging, petrology, whole rock chemistry and groundmass spinel chemistry was important in developing a 3D model (Mann, 2013).

The geological domains have been modelled in 3D and are illustrated in Figure 7-7. Modelling was undertaken by DBC using GEMCOM GEMS™ software to generate triangulated “solids” built based on the logged drill core model codes and in such a way as to reflect a reasonable interpretation of the overall geology and emplacement history of the Tuzo kimberlite (Mann, 2013; Chuchra, 2013).

Figure 7-7: 3D Geological Domain Models

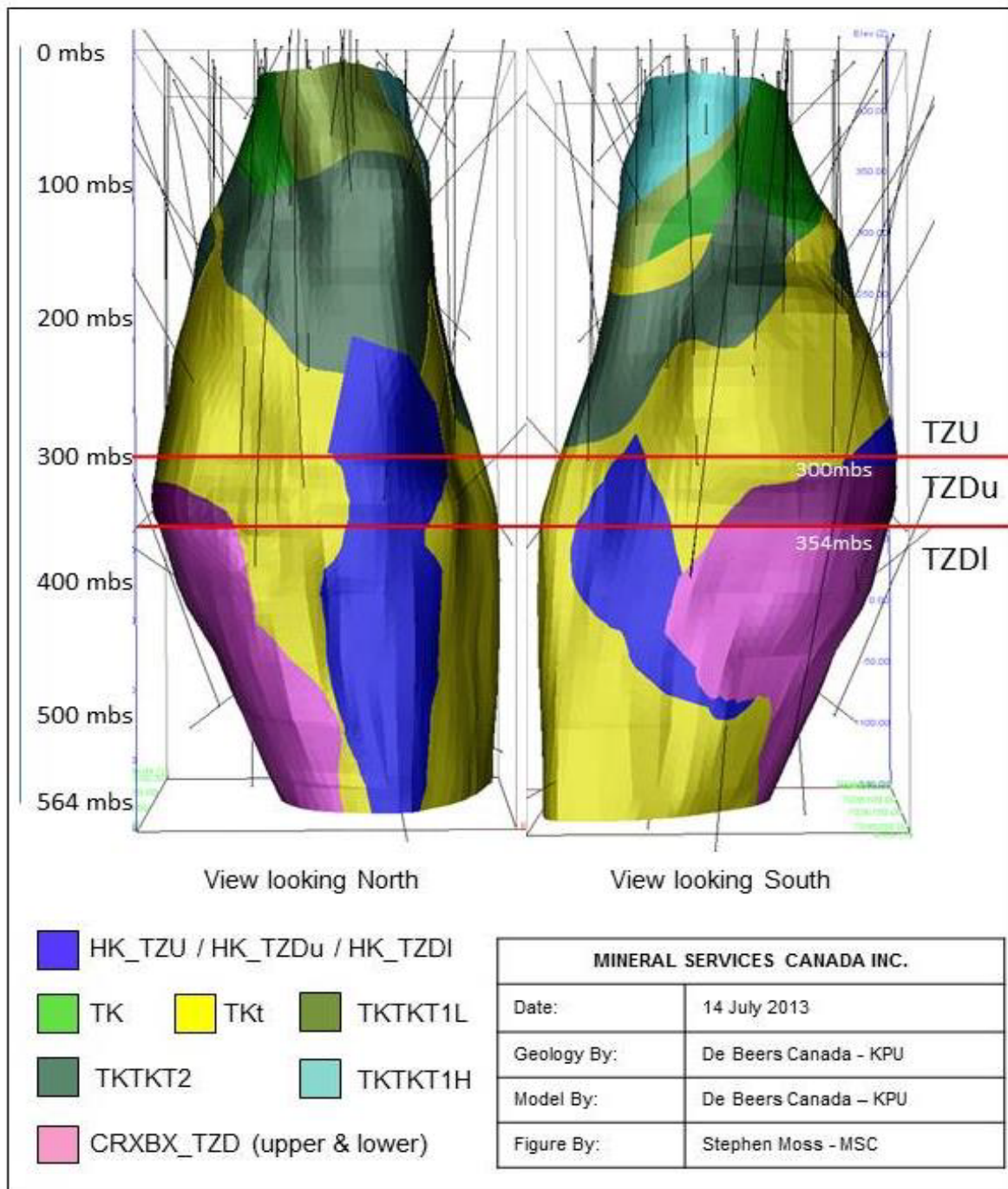

Note: The Tuzo Deep portion of the Tuzo kimberlite begins at 360 mbs; not at 354 mbs as indicated on the Figure 7-6; 354 mbs is mid-bench, 360 mbs is the lowest extent of the bench.

7.1.3.8 OTHER KIMBERLITES WITHIN THE GK PROPERTY

Several small kimberlite occurrences were intersected during exploration drilling programs following up geophysical and diamond indicator anomalies. These comprise dykes and what may be small pipes. None of these kimberlite occurrences are currently considered sufficiently diamondiferous to warrant additional work, and no additional exploration on the bodies is planned at this time.

7.1.4 COMMENT

5034 South and Hearne South could benefit from additional drilling to better define the limits of the body, whereas 5034 West could benefit from additional drilling to better define internal geology. All bodies remain open at depth.

7.2 Mineralization

7.2.1 HEARNE KIMBERLITE

Five different phases of TK were recognised within the Hearne kimberlite (Figure 7-8).

Figure 7-8: Hearne Kimberlite

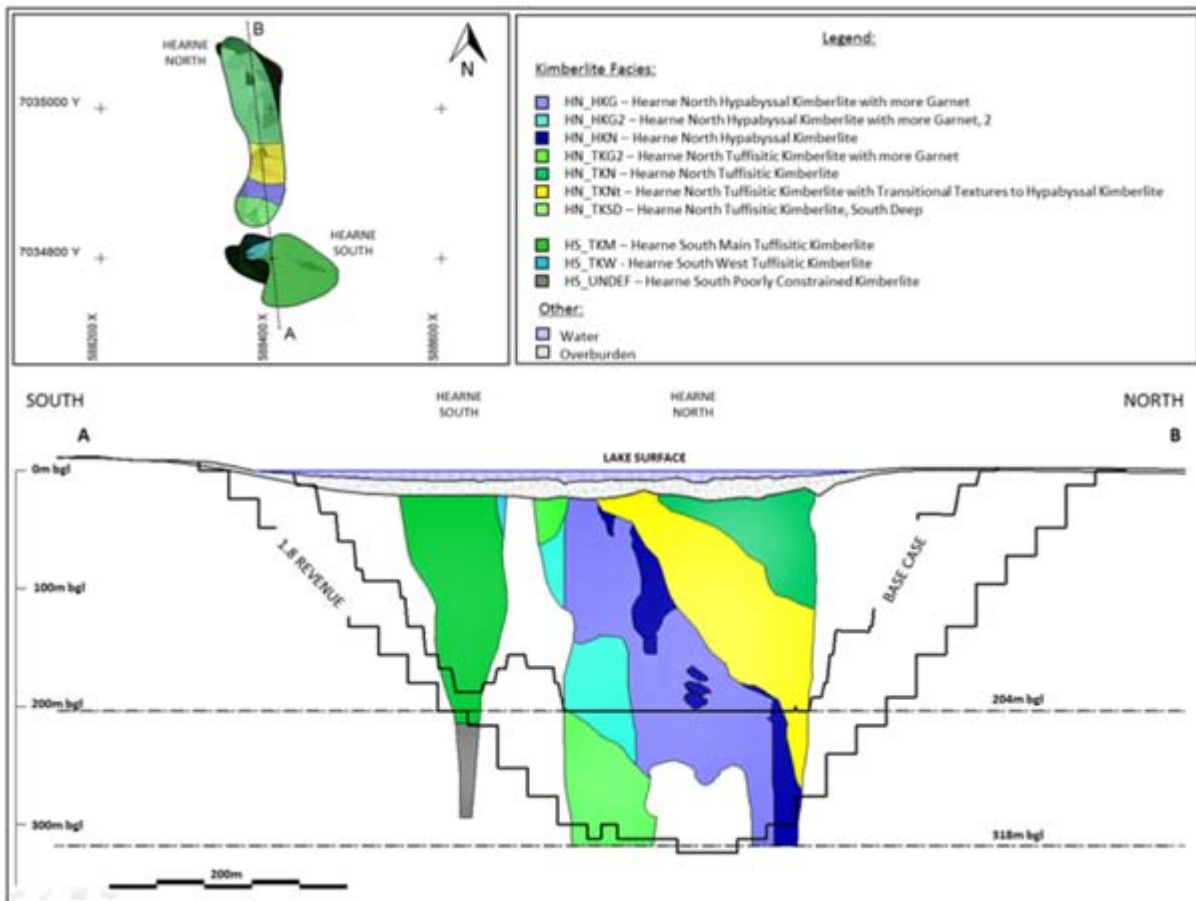

Each TK phase can be geologically distinguished using features such as varying proportions of garnets, magmaclasts, autolith-like bodies, xenoliths, and clay minerals. The names of the different TK units are based primarily on their location within the two pipes. The green–brown, partly altered TK units are easily distinguished from the fresh black HK in both core and reverse circulation drill cuttings. Different phases of kimberlite within the black HK units are very difficult to distinguish from one another. The total HK was sub-divided into three units based primarily on macro-diamond grade with some support from geological differences and spatial positions in the pipe.

7.2.1.1 HEARNE NORTH

A major TK unit in Hearne North is the HNTKN that occupies the upper northern part of the main pipe. This TK contains <15% of granite xenoliths, but does contain autolith-like bodies and magmaclasts. The TK grades with depth into transitional textures grading towards HK. The transition zone was termed HNTKNt. This unit was geologically modelled using the upper limit of HK and the lower limit of TK textures logged in both core and reverse circulation holes. Below the transition zone is HK, some of which appears to be of the same phase of kimberlite as the overlying TK and TKT. The internal contact separating the TKN and TKNt is sub-parallel to the contact with the underlying HK. Both internal contacts dip at approximately 50° to the north. The HK immediately underlying the HNTKNt is thought to be part of the same phase and was termed HNHKN. This interpretation is supported by the similarity in macro-diamond grade between the textural varieties of kimberlite. These three textural units (HNTKN, HNTKNt, and HNHKN) represent the transition from the diatreme to the root zone within a single phase of kimberlite.

Two smaller TK units, which are unrelated to those discussed above, are present in Hearne North. HNTKG2 is located near the surface at the southern end of the pipe. This unit also seems to grade into an underlying HK, termed HNHKG2. One of the main features that distinguish the two smaller TK units from the main HNTKN is the presence of fresh garnets in the former. The HNTKSD is interpreted to be a completely different, and probably earlier, phase of kimberlite partly because the HNTKN and HNTKG2 exhibit gradational changes to HK at shallower levels in the pipe than the HNTKSD.

Although the HNHKN, discussed above, is interpreted as being related to the HNTKN, other HK units appear to be unrelated. Geologically, the latter HK units seem to contain more garnets than the HNHKN. There also appears to be sharper contacts rather than gradational changes between these and the overlying TK units. The volumetrically largest of these HK units, HNHKG, is correlated with the low-grade areas within the HK found in many of the large diameter holes. The HNHKG2 is nearly indistinguishable from the HNHKG in core.

7.2.1.2 HEARNE SOUTH

Based on geological interpretations from limited core drilling, this body appears to be composed mainly of uniform diatreme-facies TK, containing as much as 50% granite xenoliths. The TK unit was named HSTKM. A separate transitional HK/TK was proposed and named HSTKW. The macro-diamond grades in both of the above units are similar.

7.2.2 5034 KIMBERLITE

Kryvoslyk (2008) reported that the diamond distribution in the 5034 North Lobe appears to follow the layered character of the kimberlite overall (refer to Figure 7-9). Maximum concentrations of diamonds appear often located close to the “Orange Marker” — a specific petrological layer generally found between the two units comprising the majority of the pipe infill: the upper HKt and the lower HK units. Diamond count maxima in the East Lobe appear to create a lens-like body at a depth of 85 to 131 m towards its flanks and 107 to 211 m in its centre.

Figure 7-9: 5034 Kimberlite

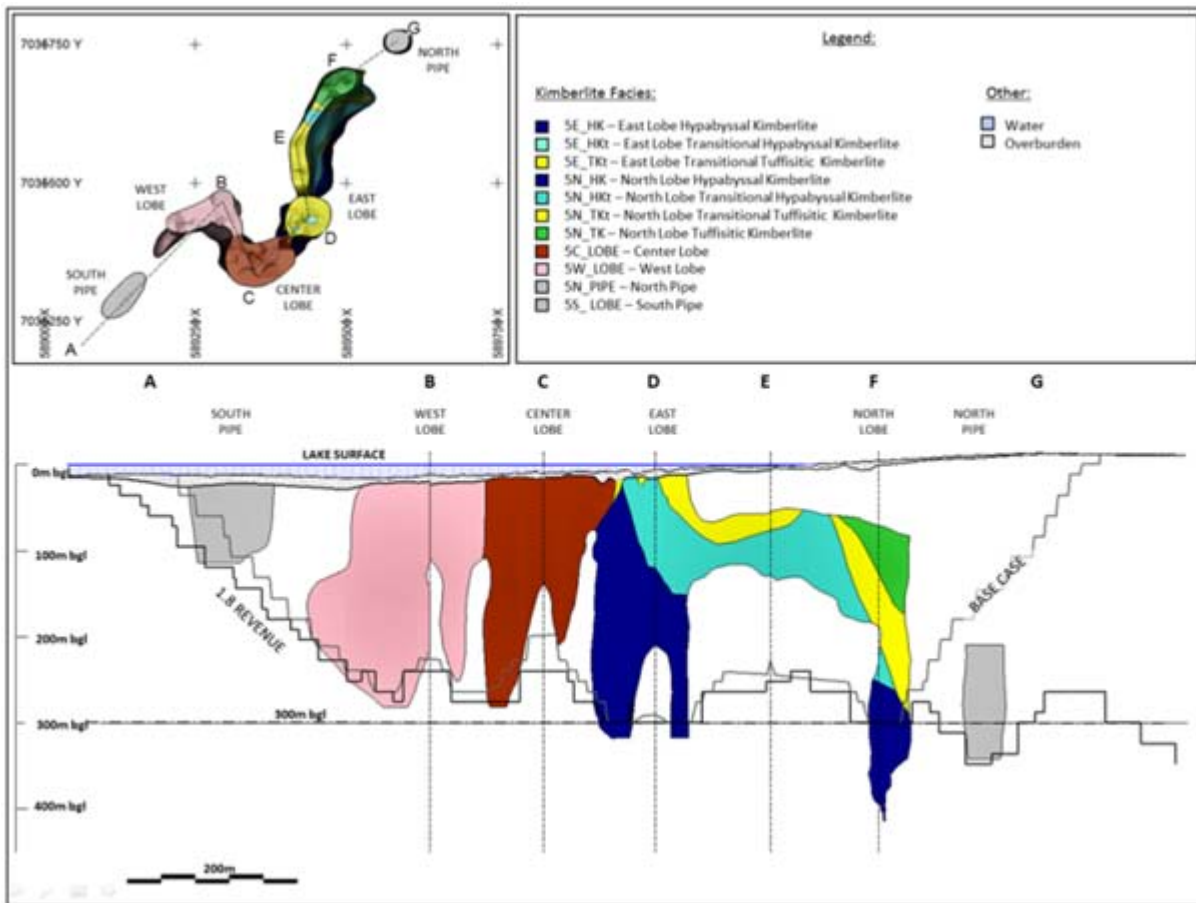

Limited diamond and geological data for the Centre and West lobes did not allow Kryvoslyk (2008) to produce high-confidence 3D models. The Centre Lobe macro-diamond distribution is highly variable and poorly supported by petrology, even between relatively closely spaced drill holes. The Centre Lobe micro-diamond distribution showed the presence of high-grade zones, which did not correlate with petrological changes. The resource model considers the West Lobe to be undifferentiated kimberlite and the Centre Lobe to be composed entirely of undifferentiated HK.

Kryvoshlyk (2008) concluded that the generation of the transitional kimberlite rock textures at 5034 is still poorly understood. If the transitional rock types are in-situ differentiates of HK magma, Kryvoshlyk (2008) maintains that they should play only a minor role in understanding the diamond distribution.

7.2.3 TUZO KIMBERLITE

Seghedi and Maicher (2007) reported that the kimberlite units of the Tuzo kimberlite pipe are characterised by a large variation of diamond counts in both micro as well as macro grain size classes, likely due to varying levels of dilution within the kimberlite (Figure 7-10). One of the aims of the 2007 drill program was to better delineate the pre-2007 established high-grade and low-grade units. Volumetrically significant lithologies with elevated diamond counts are found in the coherent HK and HKT units at depth. The fragmental lithologies in contrast have the lower stone counts, which seem to correlate negatively with country rock dilution. Seghedi and Maicher (2007) maintained that overall, the diamond distribution appears to be unrelated to spatial or depth levels, but more correlated with the abundance of dilution in an area. This in turn confirms the geological observations and geochemical data.

Figure 7-10: Tuzo Kimberlite

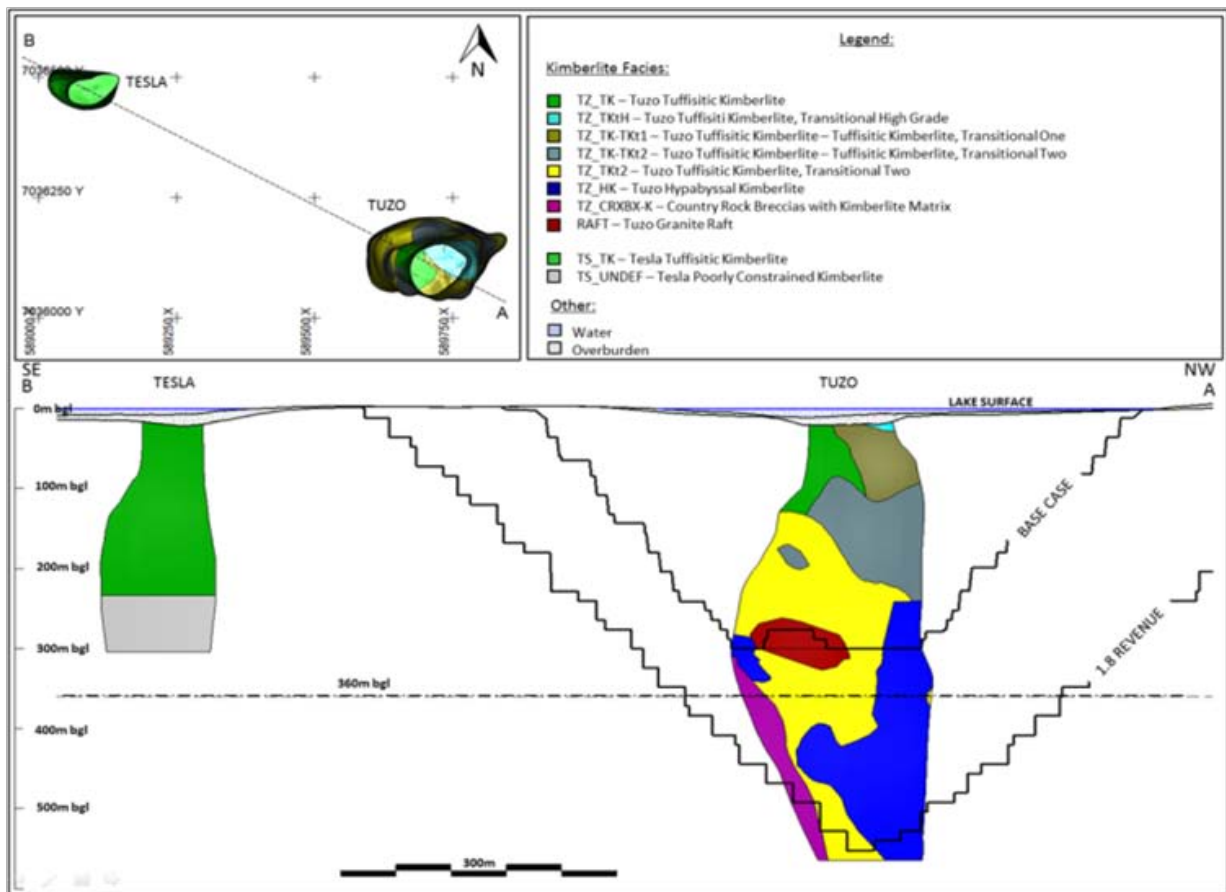

A previous interpretation of the emplacement mechanism of the Tuzo Pipe by Hetman et al (2004) proposed that the pipe is a transition zone representing a “frozen” degassing front of a single phase of intrusive kimberlite. Seghedi and Maicher (2007) concluded that the emplacement of the Tuzo pipe was a process extended over a period with repeated eruptions of variable magnitude and nature, with resedimentation and recycling of volcanoclastic material being evident.

Micro-diamond stone counts per sample were found by Seghedi and Maicher (2007) to be highly variable, both within and in between geological units. The abundance of xenoliths within a sample correlated negatively with total stone counts, and thus the highly variable degree of country rock dilution is thought to contribute to the large range of counts. According to Seghedi and Maicher (2007), the pre-2007 high-grade unit could not be confirmed with micro-diamond data obtained from the 2007 core program. The pre-2007 high-grade unit was found to have, on average, a lower degree of dilution than the surrounding lower grade unit. For the high-grade unit, no criterion was found by Seghedi and Maicher (2007) to consistently discriminate the unit.

It was concluded by Seghedi and Maicher (2007) that:

- The kimberlite units of the Tuzo kimberlite pipe are characterised by a large variation of diamond counts in both micro and macro grain size classes.
- There are distinctive differences in the absolute value of diamond stone counts of fragmental vs. coherent units, which appears partly related to their degree of dilution, but also to possibly different batches of magma.
- The stone counts are strongly affected by the degree of dilution. However, no distinctive separation of or internal homogeneity within a unit is found by eliminating the dilution. Outliers occur in country rock xenolith rich breccia zones.
- A distinct correlation of stone ratios is not found for any of the lithologies. (Ratios of diamond grain size classes are expected to be constant within a unit, irrespective of various effects that alter the absolute numbers of stones, including the degree of dilution. Thus, individual batches of magma that have sampled different areas of the mantle for diamonds are expected to have different stone size ratios.)
- Geochemically, some of the element vs. micro-diamond data plots indicates a subtle correlation of the major model codes distinguished in Tuzo kimberlites, although extensive scatter prevents the definition of a distinct criterion.
- For the pre-2007 high-grade unit, there was no criterion to consistently discriminate this unit or even confirm its existence as a separate unit.

Stiefenhofer (2008b) reported an investigation to attempt to clarify the apparent existence of a high-grade unit in the Tuzo Pipe, and commented on the validity of retaining this unit in the geological model. The investigation focused on a review of observations by past workers, reappraisal of new geochemical data generated in 2007, the methods used to calculate crustal dilution, distribution of granite dilution within the pipe, distribution of diamond grade within the pipe, and lastly,

consideration of the potential role that volcanic processes may have played in the generation of the high-grade feature. Stiefenhofer (2008b) concluded that geological evidence for the existence of a high-grade zone was circumstantial at best. Stiefenhofer (2008b) stated that ultimately, however, it appears that the High Grade zone was derived from magma with similar rare earth element (REE) chemistry compared to the remaining fragmental units. (It should be noted that the 2008 RC drilling mini-bulk sampling program did confirm the high macro-diamond grade zone delineated by the 1999 RC drilling mini-bulk sampling program.)

The possibility of a temporary obstruction during the course of the eruption and emplacement of the Tuzo Pipe was considered by Stiefenhofer (2008b) to be the most likely explanation for the High Grade zone. He speculated that the introduction of the granite raft, combined with the additional smaller blocks and fragments of granite, proved to be too voluminous for the volcano to eject at once. The feeder was forced to deviate around this obstruction, and the eruption continued. The 3D orientation of this zone of granite debris (defined largely by unit TKTKt_2) suggested to Stiefenhofer (2008b) that the new vent position was located along the eastern wall of the pipe. It is possible the proximal position to the vent will have locally influenced the diamond stone size and grade, thereby defining the High Grade zone.

Tappe (2009) reported on a preliminary groundmass spinel chemistry study to support the evaluation of a reconciliation of a high-grade unit with the 2007 Tuzo geological model. Tappe stated the data suggested that the High Grade zone of unit TK-Tkt_1 and the low-grade unit TK-Tkt_2 are derived from a common magma batch and that the difference in diamond grade is primarily a function of country rock dilution. The analyzed low-grade units contain multiple spinel populations, some of which are not observed in the High Grade zone. This suggests that mixing of different magma batches occurred. According to Tappe, there appears to be an affinity of the Tkt_1 model code, which is part of the high-grade material close to the surface, to HKt material at greater depths. Further groundmass spinel studies completed by Mann (2013) support the continuity between the geological units in Tuzo Deep with the upper regions of the kimberlite. There is compelling evidence that the TKT units in Tuzo Upper are the same as the TKT at depth, similarly the HK at depth is the same as the HK in mid levels of the kimberlite.

7.2.4 OTHER KIMBERLITES

Several small kimberlite occurrences were intersected during exploration drilling programs following up geophysical and diamond indicator anomalies. These bodies include the Tesla Pipe, Dunn Sheet and Wallace occurrences that comprise part of the Gahcho Kué kimberlite cluster; the Faraday and Kelvin kimberlites are located about 8 km northeast of the Gahcho Kué kimberlite cluster and are outside the mining lease. None of the satellite kimberlites are currently considered to be sufficiently economic to warrant additional work, and no additional exploration on the bodies is planned at this time.

7.2.5 COMMENT

The kimberlite geology and mineralization within the Hearne, 5034, and Tuzo pipes is in general quite well understood, and is adequate to support mineral resource estimation.

SECTION 8 DEPOSIT TYPES

The composite geological model of the Gahcho Kué kimberlite pipes (from Hetman et al., 2003) is shown in Figure 8-1. The shape and infill of the individual kimberlite pipes is similar to that of the kimberlites located in the Kimberley area of South Africa. They are, however, different from many other Canadian kimberlites, such as those found at Fort à la Corne, Attawapiskat, and Lac de Gras (Field and Scott Smith, 1999). In general, the other Canadian deposits comprise the upper levels of the pipes. The Fort à la Corne pipes are preserved as craters with kimberlite pyroclastic aprons around the craters. The Lac de Gras pipes are preserved as diatremes below the surficial craters and above the root zones. Gahcho Kué pipes preserve minor pyroclastic kimberlite attributed to the diatreme, but largely contain root-zone materials.

Hetman et al (2003) interpreted the Gahcho Kué pipes to be similar root-to-diatreme transition zones to those described by Clement (1982) and Clement and Reid (1989). According to Hetman et al (2003), the variations in pipe morphologies and infill displayed by the Gahcho Kué kimberlites reflect varying depths of diatreme development and are not a function of different depths of erosion for each of the pipes according to Hetman et al (2003).

With respect to emplacement, Hetman et al (2003) stated that the observed gradational TK to HK textures at Gahcho Kué are consistent with the interpretation by Clement (1982) and Clement and Reid (1989) in which the degassing of an intrusive magma column produces the diatreme zone, with the underlying transition diatreme root zone representing a “frozen” degassing front, as discussed by Field and Scott Smith (1999).

Kryvoshlyk (2008) considered that the diamond distribution in the 5034 North–East Lobe appears to follow the layered character of the kimberlite overall. Maximum concentrations of diamonds are often located close to the “Orange Marker” — a specific petrological layer generally found between the two units comprising the majority of the pipe infill: the Upper HKt and the Lower HK units. Kryvoshlyk (2008) further maintained that the diamond count maxima specifically in the East Lobe appear to create a lens-like body at a depth of 85 to 131 m towards its flanks and 107 to 211 m in its centre.

Seghedi and Maicher (2007) reported that, overall, the diamond distribution at Tuzo appears to be unrelated to spatial or depth levels, but is more related to the abundance of dilution in an area. This in turn confirms the geological observations and geochemical data. The pre-2007 established Tuzo high-grade unit could not be confirmed as separate using the micro-diamond data obtained from the 2007 drill program. However, the 2008 LDD program confirmed that higher macro-diamond grades occur in this zone, and the High Grade zone was re-incorporated into the 2007 resource model. The Seghedi and Maicher (2007) investigation demonstrated that the Tuzo Pipe is geology is complex.

Figure 8-1: Composite Geological Model of Eroded Gahcho Kué Kimberlites

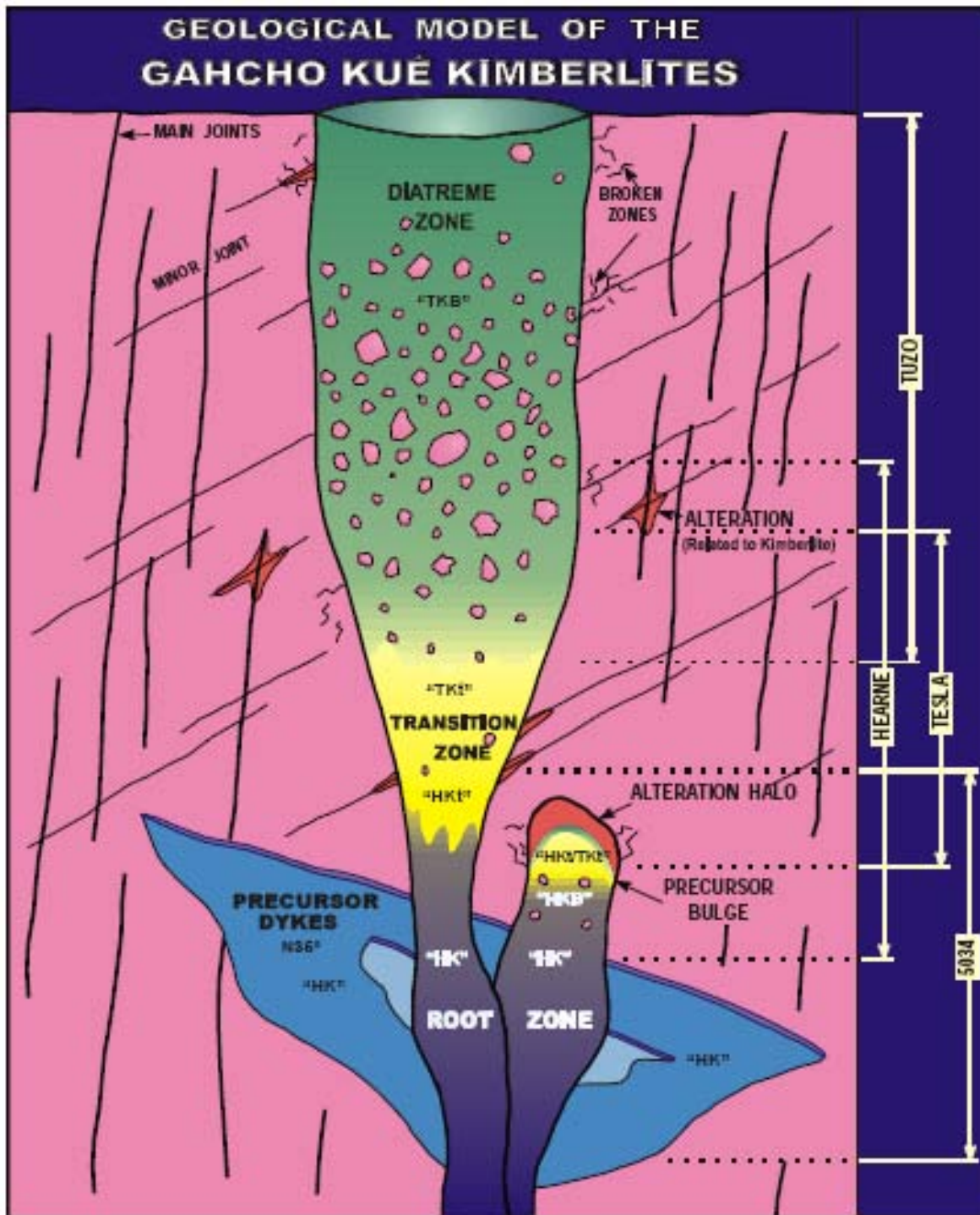

SECTION 9 EXPLORATION

The information contained in this section is based on the “Gahcho Kué Kimberlite Project NI 43-101 Technical Report” (AMEC 2009). While historical information in nature, the information has been incorporated in the Exploration section for continuity and completeness. Exploration at Gahcho Kué has included surveying, geological mapping, geophysical surveying, geochemical sampling and hydrological / geotechnical work.

All exploration was implemented directly by DBC or was subcontracted out under direct supervision of DBC as the project operator. Exploration / delineation drilling, as well as all related sampling and processing of drill material, is described in Section 10.

9.1 Survey

The Gahcho Kué site was surveyed by GKJV in 1998 using the North American Datum (NAD) 27 coordinate system, with elevations recorded in height above ellipsoid (HAE)¹.

All pre-2004 drill hole collars at Gahcho Kué were surveyed using UTM NAD 27 Zone 12. Pre-existing survey control for the Base Station at the site references a First Order Geodetic Monument located near the Hoarfrost River. This coordinate was established by global positioning system (GPS) survey between 1996 and 1998 by GKJV. A surface grid tied to the UTM system was established during 1997–1998 over each of the kimberlites. Several permanent reference points within each grid were established on land using a Trimble 4800 series GPS. These reference points were re-occupied by GKJV in 1998 with a Trimble 4800 series GPS, which confirmed the accuracy of the original locations (Hodgkinson, 1998).

From November 2003 to January 2004, GPS determination of Canadian Active Control Network (CACS) NAD 83 coordinate values with elevations in masl for the GPS Base Station at Gahcho Kué was performed using two independent methods (Hewlko, 2004). The first method¹ involved the processing of CACS data and satellite data collected at the base station in November 2003 and January 2004. The resulting six positions agreed within 3 cm in the northing direction, 3 cm in the easting direction, and 9 cm in elevation. The second method of determining the position of the base station was to process the data observed at the base station by single point positioning. The six positions agreed within 0.6 m in the Northing, 1.1 m in the Easting and 1.7 m in Elevation. All drill hole collars surveyed for the 2004–2008 drilling programs utilised real time GPS CACS NAD 83 coordinates.

Unless otherwise noted, drawings and coordinates are based on the NAD83 coordinate system, with elevations in masl, and are referenced to the CACS benchmark located in Yellowknife.

(1) The term above mean sea level (amsl) refers to the elevation (on the ground) or altitude (in the air) of any object, relative to the average sea level datum. As sea level can vary depending on air pressure, an alternative can be used, where base height measurements are referenced to an ellipsoid of the entire earth. HAE is the base reference for all GPS instruments.

The following shifts were used to convert the NAD27 HAE system to CACS NAD83 masl:

- Northing Shift:..... +221.619 m
- Easting Shift: -64.211 m
- Elevation Shift: +16.917 m

The shifts noted above differ from the theoretical shift between NAD27 HAE and NAD83 masl because of the enhanced survey accuracy achieved by tying into a CACS benchmark.

9.2 Geological Mapping

A 16 km² area near Kennady Lake was selected in 1998 for geological mapping at 1:2000 scale) using air photo bases. The purpose of the mapping project was to document the bedrock geology, structural geology, surficial geology (overburden type), and drainage patterns within the area.

9.3 Exploration Programs

No work was conducted by the original claim staking company, Inukshuk. Exploration between 1992 and 1996 was conducted by Canamera Geological Ltd. (Canamera) as the operator for MPV and its predecessor company Mountain Province Mining. From 1997, the GKJV was responsible for all exploration, with De Beers as “project operator” performing the work as directed.

9.3.1 CANAMERA GEOLOGICAL LTD.

Canamera Geological Ltd. acted as the operator for Mountain Province Mining Inc. prior to the joint venture with Monopros Ltd. (De Beers). Exploration work carried out by Canamera between 1992 and 1994 comprised 993 reconnaissance and follow-up glacial-till samples and an airborne electromagnetic survey. From 1995 to 1996, additional exploration included bedrock and surficial mapping, airborne and ground geophysical surveys, and collection of 1,842 sediment samples.

In January 1995, the AK5034 (5034) kimberlite was discovered, and from 1995 to 1996 it was tested by 68 exploration and delineation NQ core holes. In addition to the core drilling, geotechnical investigations of the kimberlite were completed by Canamera and Bruce Geotechnical Consultants Inc. Data collected included core recovery, rock quality designation, lithological information and alteration, point load tests, preliminary determinations of rock mass types, strength ratings, and preliminary determinations of slope requirements for rock mass types.

In 1996, a 105.2 tonne mini-bulk sample of the 5034 kimberlite was obtained by PQ core drilling of 43 holes for macro-diamond recovery. Material from NQ delineation holes completed in 1996 contributed an additional 10.2 tonnes to the mini-bulk sample.

9.3.2 GKJV

Initial exploration by the joint venture in 1997 comprised a low-level airborne magnetic and five-frequency electromagnetic (EM) survey over the AK property. Geophysical anomalies generated from

the surveys were followed by 2,211 sediment samples, 652 m of NQ core in five holes, and 85.35 m of reverse circulation drilling in four holes. Eight targets were identified in the AK property from this work, and included the discovery of three additional kimberlites: Tesla in May 1997 and Tuzo and Hearne in August 1997. Delineation drilling on the four kimberlites (including 5034) comprised nine NQ diamond holes for 2,658.89 m.

During 1998, exploration stage sediment sampling (945 samples) and diamond drilling programs (664 m in four holes) were performed. Thirteen drill holes (2,673 m) were completed in 1999 on geophysical targets from airborne and ground geophysical surveys. A total of 708 sediment samples were collected primarily in the southern portion of the AK property. The sediment samples included material for geochemical analysis collected from a detailed grid up- and down-ice of the Gahcho Kué kimberlites.

The 2000 exploration program included airborne and ground geophysical surveys, and collection of 670 20-litre indicator mineral samples and 385 geochemical samples. Sample collection was primarily from the southern portion of the AK property.

Detailed electromagnetic surveys at 40 m line spacing and 20 m station spacing were conducted at Kennady Lake near 5034, Hearne, Tuzo, and Tesla, and 12 km to the northeast over the Kelvin kimberlite intrusion. The electromagnetic data collected during this survey completed full coverage of Kennady Lake south of Tesla, and mapped the full extent of the Dunn dyke.

A total of 23 geophysical targets were drill-tested, one NQ core hole was drilled at the Hearne kimberlite, and three holes tested the Dunn anomaly, located about 250 m west of the 5034 and Tuzo kimberlites, for a total 543 m drilled.

Six ground gravity surveys and four extensions to grids were completed in the AK Claims in 2003. In addition, glacial sediment sampling was undertaken (21 samples).

A total of 1,198 line kilometres of airborne gravity survey was completed in October of 2011, covering the extent of the project area.

There were 564 m of core drilling at the Kelvin kimberlite (five holes), 330 m drilled at the Faraday kimberlite (three holes), 250 m drilled on possible extensions to Hearne (two holes), 200 m drilled on a possible extension to 5034 (one hole), and 101 m (one hole) drilled on an exploration target southwest of the Tesla kimberlite.

9.4 Delineation Programs

Delineation drill programs were undertaken from 1997 to 2008. Drilling and sampling of the deeper portions of Tuzo was undertaken from 2010 to 2013.

In conjunction with the Tuzo deep drilling programs, additional drilling was conducted to delineate geophysical anomalies identified during geophysical surveys conducted during 2012. These programs

consisted of a flown 1037 line-km survey followed by 3230 ground gravity surveys. 12 holes, totalling 1064.8 m of drilling, were drilled to delineate the anomalies identified during geophysics surveys; however, no new kimberlites were identified.

9.5 Petrography, Mineralogy & Other Studies

Detailed petrography and mineralogy is an integral part of GKJV's exploration process. Reports include Caro and Kopylova (2004), Hetman et al. (2004), Kryvoshlyk (2007), Seller (2008), Kryvoshlyk (2008), and Mann (2013).

Details of methodologies are discussed in Webb et al. (2006), Field and Ferreira (2006), Seghedi and Maicher (2007), Stiefenhofer (2007), Kryvoshlyk (2008) and Mann (2013). Methods include abundant use of thin sections and polished slabs, detailed mineral counts, and whole-rock geochemistry.

9.6 Hydrology & Geotechnical

Golder Associates (Eichenberg, 1999) trained GKJV personnel in the geotechnical aspects of core logging, and in 1999 a geotechnical study was performed by Golder Associates (Eichenberg, 1999). The Laubscher rock mass classification system was used to assess the geotechnical data. Geotechnical units identified were based on fracture frequency, rock strength, and joint conditions, in country rock and in kimberlite. The following work was performed:

- core orientation, fracture frequency, rock strength and joint conditions were measured
- rock mass rating and rock mass strength for each unit was calculated.

Point load testing of kimberlite and country rock xenoliths from the Tuzo 2002 HQ core specimens was performed (Charlebois, 2003). The aim of this exercise was to obtain fresh point-load strength index data for comparison against possible future rock-strength classification by ore dressing studies (ODS).

Geotechnical and geohydrology consultants were employed on site during the 2004 drilling program for detailed logging. A standard geotechnical logging template developed by SRK was used to record field drill hole data, including geotechnical logs, field geological log, density sample results and down-hole survey measurements. A site-specific geotechnical discontinuity atlas was produced. SRK supervised a geotechnical drilling program in the area of proposed open-pit mining, comprising geotechnical logging and an assessment of geological structures, rock strength, and hydrogeology for pit design and slope optimization.

Hydrology and geothermal drilling programs were also completed in 2004, supervised by HCI Hydrologic Consultants, Colorado, USA. Work comprised hydro-structural drilling of faults and potential lake dewatering dykes. Hydrological data for hydrological modelling were tied into environmental baseline studies. Packer testing was undertaken at 3 m and 9 to 12 m, for a total of 141 test intervals. Sub-permafrost sampling was undertaken, as was water sampling of the 5034 proposed pit, where 12 airlift tests at 30 m intervals were completed. To collect geothermal data for modelling to tie into environmental baseline studies, thermistors were installed at a depth of 250 m.

An assessment of uniaxial compressive strength and elasticity of 66 kimberlite and country-rock samples collected from the 2011/2012 core drilling campaign was carried out by Mirarco (Suorineni, 2012). Instrumented unconfined compressive strength testing was carried out on all intact core specimens.

9.7 Comment

JDS is of the opinion that the exploration to date at Gahcho Kué is consistent with industry-standard practices and is appropriate for the type of mineralization. Exploration is adequate to support mineral resource estimation.

SECTION 10 DRILLING

The property was the subject of several drilling campaigns since the initial work by Canamera Geological Ltd. in January 1995. In 1995, small diameter core drilling (47.6 mm NQ core) by Canamera Geological Ltd. discovered the 5034 kimberlite during drilling of geophysical anomalies at the head of a kimberlitic indicator mineral dispersion train.

Since then, small-diameter NQ core drilling was used extensively to test geophysical and kimberlite indicator mineral dispersion-train targets peripheral to the 5034 cluster (Tuzo and Hearne were discovered in 1997), as well as to delineate the shape of the kimberlite bodies and to provide data (including micro-diamonds) for geological and mineral resource modelling.

Large diameter core (LDC) drilling was used to collect small mini-bulk samples from 5034. In 1996, Canamera Geological Ltd. obtained PQ-sized core samples (85 mm diameter), and in 2007 GKJV obtained 149 mm diameter LDC samples. The LDC samples provide additional information (macro-diamonds) regarding the diamond content of the pipes.

Large diameter reverse-circulation (RC) drilling (LDD) was used to collect kimberlite mini-bulk samples by GKJV. LDD programs have included smaller scale 140 mm (5.5 inch) diameter drill holes in 1998 and 1999, 311 mm (12.25 inch) drill holes in 1999, to the largest employed, the 610 mm (24 inch) diameter drill holes in the 2001, 2002, and 2008 mini-bulk sampling programs. The LDD mini-bulk sample programs were obtained macro-diamonds for grade and revenue estimation.

In 2011/2012 small diameter (HQ) drilling was conducted on the Tuzo pipe to collect kimberlite samples at depth. Currently (2014) small diameter drilling is underway on the Tuzo pipe to collect further samples at depth below the currently defined resource level.

10.1 5034

Canamera Geological Ltd's 1995 and 1996 drilling of the 5034 kimberlite comprised 69 NQ core holes to obtain geological and pipe volume data and 43 PQ core holes to obtain macro-diamonds for a preliminary estimate of diamond grade. An additional 11 NQ core holes and 17 RC holes of various sizes were drilled by GKJV between 1998 and 2002. Mini-bulk sampling conducted between 1998 and 2002 to determine diamond grade and revenue has included 140 mm (5.5 inch) diameter drill holes in 1998, 311 mm (12.25 inch) diameter drill holes in 1999, and 610 mm (24 inch) diameter holes that were drilled in 2001 and 2002. The 1998 and 1999 drilling focused on the 5034 West, Centre and East lobes. In 2001, the East Lobe and the west neck of the Centre Lobe were drilled. In 2002, work focused on the narrow corridor drilled previously in 1999 through the West and Centre lobes. There was one delineation NQ core hole drilled by GKJV at 5034 in 2003.

In 2004, 13 core holes drilled into the 5034 kimberlite as part of pit geotechnical, hydrogeology, and ore dressing studies (ODS). In 2005, a single core hole for hydrogeology studies drilled through the East Lobe of 5034, and two core holes were drilled at the North Lobe of 5034 to provide additional geological data. A substantial core program followed this in 2006 that comprised 11 HQ core holes for pit geotechnical, pipe volume delineation, and geological investigations. The last campaign of core drilling was conducted in 2007 with five HQ core holes being drilled to provide geological data from the 5034 East Lobe and 5 LDC holes (149 mm, 5.875 inch) drilled into the 5034 North Lobe to obtain a small parcel of macro-diamonds for comparative purposes.

10.2 Hearne

A total of 25 core holes were drilled in and around the Hearne kimberlite by GKJV during 1997-2003:

- 17 in Hearne North
- 6 in Hearne South (1 that intersected both pipes)
- 2 of which did not intersect kimberlite.

In 1998, 19 LDD holes (140 mm diameter) were drilled into the Hearne kimberlite to test the diamond grade:

- 16 were located at Hearne North
- 1 in Hearne South
- 2 holes intersected only granite.

In 1999, eight LDD (311 mm diameter) holes were drilled into Hearne North and two were drilled into Hearne South to obtain macro-diamonds for initial revenue estimation. In 2001, three LDD (610 mm diameter) holes were drilled into the northern half of Hearne North, and five more LDD (610 mm diameter) holes tested Hearne North in 2002 to increase the parcel of macro-diamonds available for revenue estimation.

In 2004, 14 NQ core holes were drilled into the Hearne kimberlite as part of pit geotechnical and ODS programs. In 2005, a single core hole was drilled for hydrogeological studies; and in 2006, a single core hole was drilled to support pit geotechnical studies.

10.3 Tuzo

Between 1997 and 1999, eight NQ core holes were drilled into Tuzo. All of these were angle holes collared outside the kimberlite body and drilled into, and sometimes through, the kimberlite. In 2002, seven vertical HQ core holes were drilled into the pipe. LDD mini-bulk sample drilling took place in 1998 and 1999. Drilling to a maximum depth of 166 m, 17 LDD holes (140 mm diameter) were completed in 1998, and an additional 11 LDD holes (311 mm diameter) were completed in 1999 to a maximum depth of 300 m.

In 2004, two HQ core holes were drilled at Tuzo as part of a pit geotechnical study. This was followed by an 11-hole HQ core program in 2006 to provide pipe delineation and geological data. In 2007, a grid of 27 HQ core holes was completed to provide additional geological and pipe volume delineation data. The final resource drilling at Tuzo was an LDD mini-bulk sample program conducted in 2008 with nine holes (610 mm) completed to provide additional macro-diamonds for diamond revenue estimation.

An additional six HQ diameter core drill holes (4,127 m) were drilled in 2011/2012 with the purpose of further delineating the deep (300 – 564 mbs) portion of the Tuzo kimberlite and obtaining material for microdiamond sampling.

Currently a three -hole drill program is underway to test the Tuzo kimberlite to a depth of 750 mbs level.

SECTION 11 SAMPLE PREPARATION, ANALYSES, & SECURITY

Information contained in this section has been taken from AMEC's 2009 Technical Report (AMEC, 2009) and the Mineral Services' 2013 Report. JDS has reviewed the information contained in the previous Technical Reports and are of the opinion that sample preparation, analyses and security measures used meet industry standards and are adequate. Sections from these reports are included below. No additional test work has been conducted beyond the programs listed below.

11.1 Core Sample Preparation

11.1.1 CANAMERA (1994–1996)

The kimberlite intersections recovered by Canamera Geological Ltd's core drilling programs were shipped to Canamera Geological Ltd. in Vancouver BC, where the core was split after detailed petrologic logging. Portions of the split samples were processed for micro-diamonds by caustic fusion at both the Canamera Geological Ltd. laboratory in Vancouver and at the Saskatchewan Research Council facility in Saskatoon (Clement et al., 1996).

11.1.2 GKJV (1996–2007)

Core samples recovered by GKJV over 1997-2007 core drilling programs were utilised for the following studies:

- geology studies – slab and thin section analyses, petrology investigations, whole rock chemistry, heavy mineral analysis, and internal dilution estimation
- Mineral Resource estimation – density determinations, micro-diamond estimation
- geotechnical studies – slope stability analysis, rock strength point load and uniaxial compressive strength tests, concrete aggregate suitability, weathering and slake testing
- process plant design – ODS
- environmental baseline – ARD
- micro-diamond analysis.

Kimberlite core with corresponding country rock contact zones were shipped to Yellowknife, Vancouver, Toronto, or Sudbury for detailed logging by project petrologists. Core was kept intact during collection at the drill sites and packed into labelled core boxes with depth markers placed between each drilled core run. Geotechnical logging was conducted at the drill sites. After detailed petrological logging was completed off-site, project petrologists selected samples for geology studies

including slab and thin section analyses, petrological investigations, whole-rock chemistry, heavy-mineral analysis, and internal-dilution estimation.

Samples removed for slab and thin section, micro-diamond, whole rock chemistry, heavy mineral analysis, uniaxial compressive strength, ore dressing studies, acid rock drainage and slake weathering tests were removed from the core boxes, processed, and are considered destroyed. Density and rock-strength point-load samples were returned to their respective core boxes after completion of processing. Kimberlite core sampled for geology studies from the 2007 program is the only core that was split.

All unprocessed kimberlite core, along with 30 m, more or less, of the country-rock contact zones, is currently stored at a De Beers warehouse in Sudbury, Ontario. Country-rock core is stored at the Gahcho Kué site.

11.2 Mini Bulk Sample Preparation

11.2.1 CANAMERA (1996–1998)

In 1996 a 105.2 ton mini-bulk sample of the 5034 kimberlite was obtained by PQ core drilling of 43 holes with an additional 10.2 tons from 30 NQ delineation holes contributing to the total of 115.4 tons. Reportedly, 103.7 tons were processed at the Canamera Geological Ltd. diamond recovery plant (Clement et al., 1996).

11.2.2 1998 GKJV – 150 MM (5.5-INCH) RC MINI-BULK SAMPLING PROGRAM

From the 1998 mini-bulk RC drilling program, a total of 73 x 150 mm diameter RC drill holes provided 222 tonnes of kimberlite (callipered mass) from the 5034, Hearne, Tuzo, and Tesla kimberlites for a total of 7,170.32 m of drilling. The screen aperture used was nominally 1.0 mm. Samples were collected on average every 36 m, but the actual interval ranged from six to 60 m. The 1998 mini-bulk samples were processed at the De Beers Grande Prairie treatment facility at a bottom cut-off of 1.0 mm (Williamson and Hetman, 1998).

11.2.3 GKJV (1999–2008)

The 1999 LDD bulk sampling program produced 1,820.3 t of kimberlite, measured by caliper, from the 5034, Hearne, Tuzo, and Tesla bodies in 43 boreholes for a total of 10,451.2 m of drilling (Grenon et al., 1999). A nominal 1.4 mm screen aperture size with tolerances between 1.35 to 1.52 mm was employed at the drill site (Grenon et al., 1999). Drill holes were processed by individual bulk samples collected between 18 m and 24 m intervals. The process plant lower cut-off used was 1.6 mm square aperture (Williamson et al., 1999).

During the 2001 bulk sampling program, a total of 968.5 t of kimberlite were measured by caliper from seven LDD holes drilled in the 5034 and Hearne North kimberlites. The total interval of kimberlite sampled was about 1,240 m. The bottom screen cut-off at the drill rig was 1.58 mm. A

nominal 1.5 mm bottom screen cut-off was employed during sample processing that was conducted at the De Beers Grande Prairie plant (Skinner et al., 2001). Drill holes were processed by individual bulk samples collected at 12 m bench intervals.

A total of 1,919 m of kimberlite was RC drilled and sampled at the 5034 and Hearne kimberlites in 2002. The bottom screen cut-off at the drill rig was 1.58 mm. Based on caliper measurements, a total sample mass of 1,502 t was extracted. A nominal 1.5 mm bottom screen cut-off was employed during sample processing that was conducted at the De Beers Grande Prairie plant. Drill holes were processed by individual bulk samples collected at 12 m bench intervals. The 2002 LDD mini-bulk sample processing is reported in Skinner et al. (2002).

The LDC kimberlite intersection in 2007 of the 5034 North Lobe totalled 638 m, and an additional hammered kimberlite intersection of 45.4 m of kimberlite was processed. Geological logging of 5034 North Lobe LDD core determined geology units that were utilised for sample processing intervals. Sample processing was conducted at the De Beers plant in Grande Prairie, Alberta at 1.0 mm bottom cut-off, with a primary crush at -12.0 mm, and secondary crush of the -12 +6.0 mm fraction at -6.0 +1.0 mm (Skinner, 2007).

During 2008, the drilled Tuzo kimberlite intersection totalled 1,234.1 m in RC samples, and produced about 956.2 t as measured by caliper. A nominal 1.5 mm bottom screen cut-off was employed during sample processing that was conducted at the De Beers Grande Prairie plant (Thomson, 2008). Drill holes were processed by individual bulk samples collected at 12 m bench intervals.

Mini-bulk sample preparation procedures are typical of the industry and are adequate to support Mineral Resource estimation.

11.3 Analyses

11.3.1 MICRO-DIAMOND SAMPLES

Micro-diamond samples were processed at De Beers Kimberley South Africa micro-diamond laboratory (De Beers Kimberley), SGS Lakefield Research Laboratories (SGS) and at the Saskatchewan Research Council (SRC) Geoanalytical Laboratories. Selected micro-diamond and residue samples recovered at SGS and SRC have undergone audits at the De Beers Kimberley Micro-diamond Laboratory as part of routine quality assurance and quality control (QA/QC) measures.

The following discussion of micro-diamond processing is based on a visit by AMEC to the Saskatchewan Research Council micro-Diamond recovery facility in Saskatoon, Saskatchewan. Figure 11-1 is a generic micro-diamond recovery flowsheet.

11.3.2 SAMPLE RECEIVING & PREPARATION

Kimberlite samples are received by the laboratory, sorted, and assigned laboratory sample numbers. The samples are logged into the laboratory information system (LIMS) and are dried for 12–16 hours at

60° C. The samples are crushed, if necessary, to about -½ inch and split into 8 kg aliquots. The samples are removed from the oven and allowed to cool.

Figure 11-1: Generic Micro-Diamond Recovery Flow Sheet

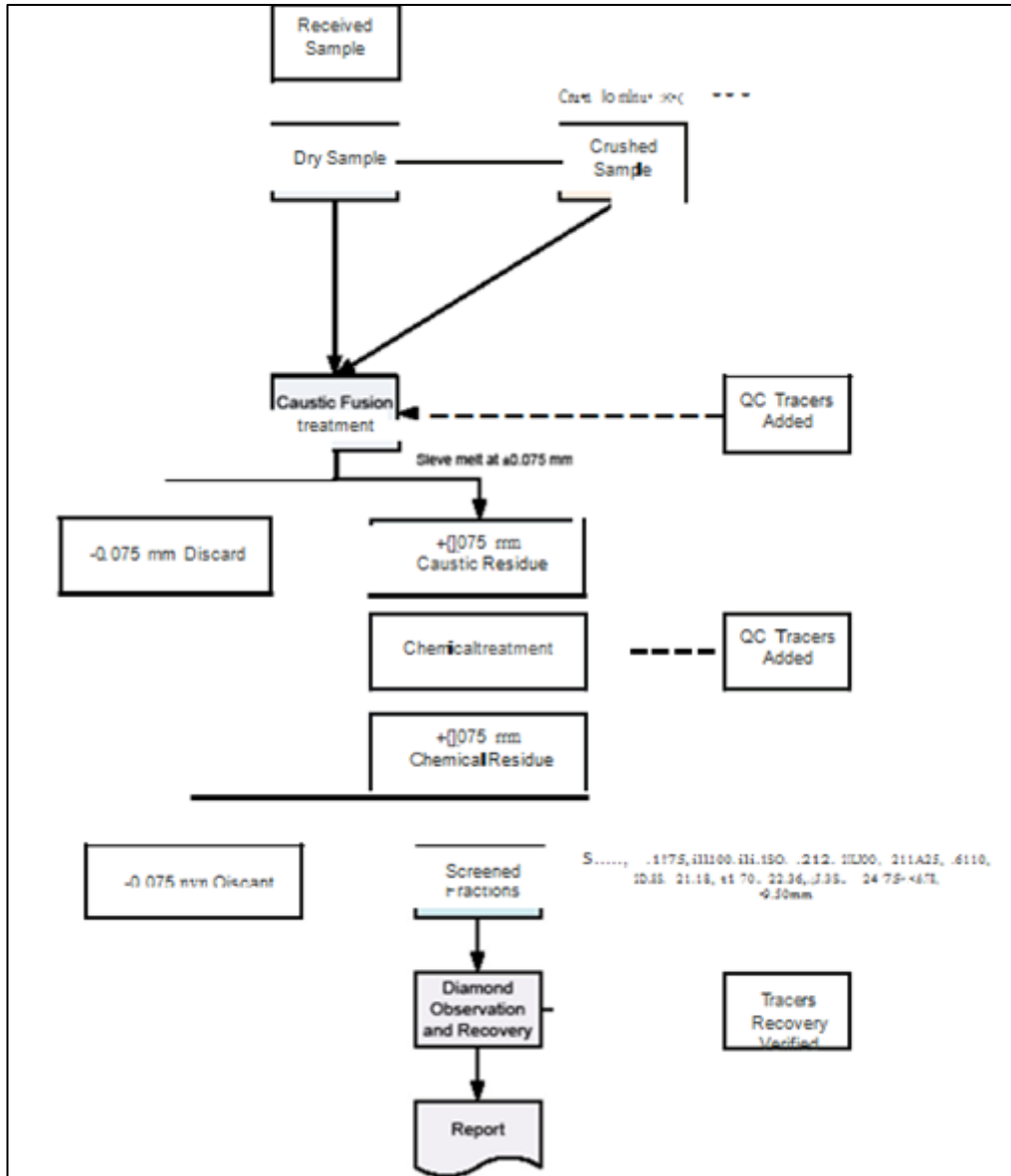

11.3.3 CAUSTIC FUSION PROCESSING

The caustic fusion process begins with placing 75 kg of virgin caustic (NaOH) in an approximately 40 L furnace pot. The 8 kg sample is then loaded on top of the caustic. Bright yellow synthetic diamonds, 150-212 µm in diameter are loaded on top of the kimberlite sample as a spike.

The temperature is then ramped up to 550° C, and the sample is held at that temperature for 40 hours. After 40 hours, the pots are removed from the kilns and allowed to cool. The molten sample is then poured through a 75 µm screen. (These screens are single-use screens that are discarded after use.) Micro diamonds and insoluble minerals remain on top of the screen. Insoluble minerals are typically ilmenite and chromite. The pot is then thoroughly soaked with water to remove any remaining caustic and trapped diamonds and the water is again poured through the screen.

Because not all of the material dissolves, additional steps are required to clean ilmenite, chromite, and other materials from the concentrate. Samples are sent to the “wet” lab where acid is added to neutralize the solution. The residue is then rinsed and treated with acid to dissolve readily soluble materials from the residue.

The sample is transferred to a zirconium crucible along with an additional bright yellow synthetic tracer diamonds and fused with sodium peroxide to remove any remaining minerals other than diamond from the sample. The sample is allowed to completely cool, and the liquid is decanted from the beaker. The remaining residue is then wet screened to divide the recovered diamonds into micro-diamond size classes. Stones are stored in plastic vials containing methanol.

11.3.4 SAMPLE PICKING, WEIGHING & DATA RECORDING

Samples are then sent to the observation room where they are handpicked by trained observers. Spikes are recovered first. After spike recovery is deemed complete, diamonds are picked from the residue and individually weighed. The weight of each stone in each size class is recorded. (In GKJV’s case, stones smaller than 300 µm are not individually weighed, but the total parcel in each size class is weighed.)

Stones are weighed on ultra-micro balances capable of accurately weighing 75 µg. Data are recorded on paper that is then manually entered into a spreadsheet by trained clerical personnel.

11.3.5 COMMENTS

The laboratory is ISO 17025 accredited for micro-diamond work. The laboratory reportedly has an average recovery efficiency of 98% based on spike recovery. Less than 70% recovery results in the laboratory absorbing the cost of the analysis and issuance of an apology to the client. This has happen only a “handful” of times since the laboratory opened.

Quality control (QC) consists of:

- every sample is picked by a designated observer, and the residue is repacked by a senior observer to insure that no diamonds were missed. The senior observer then signs off on the sample
- all observers are required to do annual retraining
- a designated Quality Control Manager is in charge of all of the QC documentation
- new observers are introduced to the process by picking tracer diamonds for two to three weeks.

They are supervised very closely for as long as four months. After that, normal QC procedures apply.

Due to the number of container transfers (7), screenings (2), and general handling of the samples, there is a very large risk of losing stones. It was obvious that the laboratory personnel are acutely aware of this and that numerous procedures are in place to minimize the possibility of lost stones. In AMEC's opinion, the procedures are appropriate.

11.4 Mini-Bulk Samples

GKJV mini-bulk samples underwent dense media separation (DMS) concentration at the De Beers DMS facility in Grande Prairie. Sealed bulk sample concentrates were shipped under "Kimberley Process"² chain-of-custody procedures to the De Beers Johannesburg, SA facility for final diamond recovery by X-ray fluorescence. The recovered microdiamonds were shipped under the same chain-of-custody procedure to the De Beers Diamond Trading Company (DTC) in London UK for appraisal and revenue analysis.

11.4.1 1999 GKJV MINI-BULK SAMPLE PROCESSING

Sample processing during 1999 was by gravity feed from the sample bag through a scrubber fitted with 12.5 mm square aperture a trommel screen, all +12.5 mm material was crushed to 10 mm and fed back into the scrubber. All -12.5 mm to 1.6 mm material was fed via a dropout box onto a 1.6 mm square aperture poly-panel pre-preparation screen, where this DMS feed was washed. Following preparation, the sample was gravity fed into the mixing box from where the FeSi/sample mix was pumped through a 200 mm diameter cyclone with a 46 mm spigot.

11.4.2 2001–2008 GRANDE PRAIRIE DENSE MEDIA SEPARATION (DMS) CIRCUIT

A purpose-built 5 t/h (200 mm cyclone) DMS plant, with an integral scrubber, trommel screen, crusher, preparation screen and concentrate recovery system was installed at De Beers' processing facility in Grande Prairie, Alberta and used in 2001.

The sample material was gravity fed from the 2-ton sample bag into a 2-ton feed bin; from the feed bin the sample was fed onto a 9 m long feed-belt; feed speed was controlled by a gate in the front of the conveyor feed tray. From the conveyor, the material was gravity-fed into the scrubber, with the assistance of the crusher pump water. After scrubbing, the sample was discharged through a 14 mm trommel screen into a 4/3 Warman pump. This material was fed via the 4/3 Warman pump through a drop-out box onto the prep screen on the DMS unit. Material over 14 mm in size fell from the trommel

² The Kimberley Process (KP) (introduced by United Nations resolution 55/56) is a joint governments, industry and civil society initiative to stem the flow of conflict diamonds which are rough diamonds used by rebel movements to finance wars against legitimate governments. The Kimberley Process Certification Scheme (KPCS) imposes extensive requirements on its members to enable them to certify shipments of rough diamonds as "conflict-free". As of September 2007, the KP has 48 members, representing 74 countries, with the European Community and its Member States counting as an individual participant. See Section 13.8 for additional information.

screen lip into a 6 x 4 Masco jaw crusher, set to a 10 mm closed-gap setting. This crushed product was gravity fed into a 3/2 Warman pump and returned to the scrubber. In this way, the circulating +14 mm oversize material remained in closed circuit until reduced to below 14 mm in size. Due to the minimal amount of +14 mm material present in the samples, the jaw crusher could not be choke-fed during production; however, most of the oversize material preferentially, remained inside the scrubber during feeding. This material was choke-fed through the crusher when the scrubber was reversed during clean-out at the end of treatment of each sample.

During processing, fines (-1.5 mm material) are removed on the preparation screen, while the sample material is split into high- and low-density components in the cyclone. Sample concentrate reports to pails within a concentrate cage, and tails are collected in a per-numbered sample bag and stored on a per-sample basis. The single deck prep screen is fitted with 1.6 mm square aperture poly-panel screen panels and a set of spray bars. After washing on the prep screen, the sample material is gravity fed into the DMS mixing box, where the sample material is mixed with the dense medium (270D grade ferrosilicon (FeSi) and water mix). This mixture is pump-fed at a pressure of ~98 Kpa into a 200 mm DMS cyclone with a 46 mm spigot. Lights (sample tailings) from the cyclone are drained and washed across the lower deck of a double deck product screen to recover FeSi and discharged to a bulk-sample bag for weighing and storage. Spigot product from the cyclone (DMS concentrate) is similarly washed across the upper deck of the double deck product screen (1 mm square poly-panel) and gravity fed to a 20 litre concentrate pail, located within a secure cage.

DMS concentrates are collected into a pail within a cage that is secured by two padlocks and two single-use security seals. The pail is sealed while inside the glove-box equipped concentrate cage, before being removed from the cage and weighed. These concentrate drums were all sealed with uniquely numbered security seals and were then stored in a locked transport container prior to shipment.

A video camera was installed inside the transport container (which was also alarmed), and two cameras overlooked the treatment plant concentrate cage. Two seals, as well as two padlocks, seal both the cage and transport container. The plant supervisor and the operator each held a key to one of these padlocks; consequently, neither the cage nor the concentrate container could be opened without both the plant supervisor and the operator being in attendance.

Prior to export, concentrate pails were drained of water, weighed, and boxed within a palletised wooden crate, which was firmly screwed together and then strapped using metal bands. Uniquely numbered, tamper-evident seals were strategically placed on these straps to detect unauthorised opening the crates. Sample shipments were made on a regular basis. Shipments would be collected from the Grande Prairie premises by a Brinks Inc. armoured vehicle and driven with an armed escort, to the Edmonton airport, where they were air-freighted to Johannesburg via London.

Following DMS concentration, an overall concentrate percentage yield (concentrate mass divided by sample mass calculated from caliper measurements of hole diameter) was recorded. An overall

sample recovery was calculated by dividing the headfeed sample mass by the sample mass calculated from caliper measurements of the hole diameter. All samples were subjected to similar processing, except for clay-rich samples, where small clay balls could still be found in the tailings following treatment. Such samples were re-processed.

Other measurements recorded during processing include moisture content and representative screening analysis of the tailings material. The treatment plant's operational parameters were recorded. This included measurement of operational time-and-motion information with discrimination of operational activities and downtime. Medium density was recorded regularly, as was the operating-medium pressure at the cyclone. Testing with density tracers was routinely undertaken, and the density cut-point and probable error (Ep) were determined.

Various measures were implemented to prevent sample contamination. The plant was cleaned after every sample. This involved a thorough cleaning of the scrubber, feed bin, pumps, screens, etc. A more thorough clean-out and a clean-up procedure was followed between processing material from the different kimberlite pipes.

In an attempt to avoid contamination, the scrubber was reversed and pressure-washed. Spillage was collected from beneath the plant and re-introduced into the process stream. All screens were hosed and unblinded between samples. The cyclone-feed pump would be stopped and restarted, to dislodge any trapped grains. The plant was operated without load for 15 minutes between samples in order to flush out any entrained material, in an attempt to prevent contamination between samples.

Macro-diamond sample preparation and recovery was performed using industry-standard procedures. The resultant diamond populations are adequate for Mineral Resource estimation and mine planning.

11.5 Program Quality Assurance/Quality Control

11.5.1 CANAMERA GEOLOGICAL LTD. 1992-1996 QA/QC

Monopros Ltd. undertook a due diligence study of the 5034 kimberlite and the AK and CJ claims in 1996 (Clement et al., 1996). The study encompassed:

- assessment of the information supplied by Mountain Province Mining Inc.
- discovery history
- local geological and topographic setting
- Kimberlite discoveries
- pipe location and general geology of the occurrence
- petrological and mineralogical results and reports
- borehole information

- drill sampling information
- geophysical surveys
- details of micro-diamond samples
- geochemical analysis of indicator minerals
- macro-diamond sampling and diamond valuation
- treatment procedures for macro-diamond samples
- access to diamonds for examination and valuation.

Kimberlite drill core received from Canamera Geological was transported from Vancouver BC and initially stored in the De Beers' warehouse in Grande Prairie, AB, moved to the De Beers' warehouse in Yellowknife, NWT and subsequently to De Beers' Sudbury warehouse facility where it is currently stored. The country-rock drill core remains on the Gahcho Kué site.

11.5.2 GKJV 1997-2003 CORE PROGRAMS QA/QC

A surface grid tied to the Universal Transverse Mercator (UTM) system was established in the winters of 1997 and 1998 over each of the kimberlites. Several permanent reference points in each grid were established on land using the Trimble 4800 series global positioning system (GPS). These reference points were re-occupied later that year, again with a Trimble 4800 series GPS, which confirmed the accuracy of the original locations (Hodgkinson, 1998).

SRK Consulting conducted three quality assurance exercises during the 1998-1999 GKJV geotechnical program (Eichenburg, 1999), covering:

- hole collar locations and drill rig setup
- core orientation (Pajari® tool and acid-test surveys)
- geotechnical measurements.

11.5.3 GKJV 1998-2002 BULK AND MINI-BULK SAMPLING PROGRAMS QA/QC

In all cases, marked or synthetic diamond tracers were added to the samples to monitor recovery efficiency. Additional QA/QC measures are discussed below.

The coordinate grid established in 1997-1998 was re-established from previously laid-out permanent markers using a Trimble 4800 Series GPS system. The LDD hole collar locations were all established by measuring from the grid (Williams, 1999). A contractor independently surveyed about 50% of the collar positions (Valeriotte, 1999)

An external audit of the procedures for the 1999 evaluation program at Kennady Lake was performed by a geologist and geostatistician from MRDI (now AMEC), during a site-visit lasting six days from 10 to 16 February 1999.

Conclusions and recommendations from that audit included but were not limited to:

- data entry and verification procedures should be reviewed to reduce data entry errors
- manual sample logging prior to treatment at the Geological Sample Processing Services (GSPS) facility results in occasional errors such as duplicate sample numbering and incorrect seal numbers on sample manifests
- more frequent field granulometry samples should be taken
- an estimate of slimes lost during dewatering of the kimberlite should be made for each hole
- security during all phases of the sample drilling and treatment is adequate and meets or exceeds industry standard
- data collected during sample treatment in Grande Prairie should be consolidated into one central entry point, with formal back-up procedures in place
- the sample treatment plant is adequate; however, the double-deck screen arrangement requires frequent monitoring during operation to ensure efficient diamond recovery
- control of security seals at the Grande Prairie facility requires attention
- DMS concentrate transportation should be reviewed to eliminate the road transport from Edmonton to Vancouver, en route to Johannesburg
- a data acquisition program be initiated to provide engineering data for a future feasibility study
- alternative containers for transporting DMS concentrate from Grande Prairie to Johannesburg should be investigated
- process equipment at the GSPS facility should be reviewed to eliminate double screening and manual de-dusting steps
- additional computer terminals should be considered at the GSPS facility to reduce waiting time and potential data entry errors
- random checks of samples revealed several discrepancies on the Geotrack sample tracking system in use at the GSPS facility.

Recommendations for improvements were implemented (Williams, 1999). Similar audits were undertaken at the Monopros Ltd. Grande Prairie, Alberta mini-bulk sample processing plant and the Geological Sample Processing Services (GSPS) diamond recovery plant in Johannesburg, SA.

Procedures during the 2001-2002 program included:

- 2001 program LDD hole collars were located using Real Time Kinematics GPS with the Leica system 500 tied in to a local GPS reference stations; collars were re-surveyed after hole completion.

- 2002 program LDD hole locations were determined using a Trimble 5700 series system GPS in Real Time Kinematics mode tied in to a local base station receiver (Rikhotso, Williamson and Podolsky 2002). Hole collars were re-surveyed after completion.
- Kimberley Process Chain-of-Custody documentation is used for all concentrate transfers.

11.5.4 GKJV 2004 – 2008 QA/QC

- density samples were subjected to a procedure based on ASTM Designation – C 97-96; variations in electronic scale output were monitored with standard weights. Density samples underwent a 1% external and 1.5% internal lab testing of duplicate density samples for verification of field density results.
- Kimberley Process Chain-of-Custody documentation.

11.5.5 COMMENT

Quality assurance-quality control measures for exploration and sample processing are adequate to support Mineral Resource estimation.

11.6 Database

Drilling data collected from the 1999–2003 exploration and evaluation programs were captured for GKJV using Access®. During 2001, a major database validation was completed, and the earlier files were consolidated into one database. Drilling data collected from the 2004–2005 Advanced Exploration programs continued to be captured using Access®.

In 2005–2006, a Datamine® geological data management system was implemented and utilised for capturing drill program data. The Datamine® data management system configures a central geological database through a series of configurable tables, columns and pick up lists with a query builder function. Hole collar survey, drilling (core and large diameter), geological and geotechnical logging, sample collection and consignment information were captured. The system has an open structure in that remotely-entered field data were copied onto a Microsoft SQL server central database in Johannesburg, South Africa.

The Mineral Resource Sampling Database (MinSAMP) model is a generic, advanced diamond sampling workflow-based repository capable of storing all sample-related data. The current Gahcho Kué Project MinSAMP model stores 2007–2008 collar survey, drilling (core and large diameter drilling), geological and geotechnical logging, sample collection and consignment, sample processing and plant configuration, diamond sorting and consignment data. The model consists of several groups of tables and views named according to the workflow process or type of data they contain. The MinSAMP database is currently running on a Microsoft SQL® server located in the De Beers Toronto office. Databases from pre-2007 drilling programs are being migrated into MinSAMP.

All DBC–KPU petrological data, such as geology logs, line scan, photographs, whole-rock chemistry, micro-diamonds, maps, cross sections, consignment, tables and scorecards, and general communications, are currently saved on a central server at De Beers Toronto office. These data are being migrated into MinSAMP for GKJV.

The Gahcho Kué kimberlites are modelled in three dimensions (3D) using Gemcom® software. Waldegger (2005b) reported that the first 3D model was completed in 1998 and that subsequent iterations were completed in 1999, and 2002. The current Gemcom® model iteration of the Hearne kimberlite was completed in 2005. The 5034 and Tuzo kimberlite Gemcom® models were completed in 2007–2008. All the final interpreted data from drilling and mapping used in both the country rock and kimberlite modelling are stored in an Access® database.

The database was internally audited during April to July 2004. Line verification was undertaken on collar location, downhole survey data, geological logs and macro-diamond data. Drill hole folders were compiled for the Gahcho Kué data room in conjunction with the audit. A major restructuring of the Gemcom® project and associated database was completed by the project resource geologist (Waldegger, 2005b).

Hard copy exploration and advanced evaluation geology–Mineral Resource estimate data including drilling program reports and individual drill hole files were compiled. The hard copy drill hole reports correspond to the drill holes in the Gemcom® database. The hard copy reports are filed and indexed in the geology and resource data room at the Gahcho Kué Project office in Yellowknife. The geology and resource data room files are also digitally copied and stored in a project “Electronic Data Management System” on a central server at De Beers Toronto office.

AMEC and its precursor MRDI audited the database in 1999, 2003, 2005, 2007, and 2008 and found no significant errors or omissions.

AMEC is of the opinion that the database is adequate to support Mineral Resource estimation. Routine backups, integrity checks and audits minimize the likelihood of significant numbers of errors finding their way into the database.

11.7 Sample Security

Security procedures were in place during bulk and mini-bulk sampling drilling programs at the Gahcho Kué site, during sample processing at the De Beers DMS facility in Grande Prairie; during diamond recovery at the De Beers Group Exploration Macro-Diamond Laboratory (GEMDL) in Johannesburg, RSA and at the Saskatchewan Research Council Geoanalytical Laboratories.

The purpose of security procedures at the Gahcho Kué site was to set out the security duties, transportation and chain-of-custody processes around the handling, storage, documentation and overall security for the bulk sampling programs. Independent security contractors were employed at the Gahcho Kué site for the 2001, 2002, and 2008 large-diameter drill hole RC bulk sampling programs.

Mini-bulk samples collected during LDD RC programs were secured in closed bags with uniquely numbered single-use security seals at the Gahcho Kué site. The chain-of-custody was maintained through a series of consignment document sign-offs and tracking of the sample and security seal numbers from the initial collection of the sample, during transportation and to the final processing stages. Field consignment records of the bag and seal number, bag weight and condition were documented.

The mini-bulk samples were transported directly from Gahcho Kué to Grande Prairie in vans that were padlocked and affixed with uniquely numbered security tags via winter ice roads when possible, or flown by commercial aircraft to Yellowknife and then transferred to closed vans for shipment to Grande Prairie.

The De Beers Grande Prairie bulk sample DMS processing warehouse is a locked facility, monitored by multi-camera video surveillance by contracted security personnel. DMS concentrate is fed into a pail within a locked cage. Once a sample is completed the pail is sealed using a glove-box arrangement. Concentrate cages and storage areas are double sealed and locked, requiring the presence of one senior GKJV person and one contracted security personnel for access. Records are kept of visitors to the facility. DMS concentrates are locked into sealed 20-L containers, each of which has a uniquely numbered, single-use seal affixed. These containers are stored inside a class-three demountable vault until periodic shipments are made to Johannesburg using a security contractor.

At the Saskatchewan Research Council Geoanalytical Laboratory macro-diamond recovery facility, GKJV security staff reviewed the security procedures and systems and made recommendations for improved camera surveillance and hands-off microdiamond sorting by glove box. The recommendations were implemented.

The De Beers GEMDL facility in Johannesburg conforms to all the De Beers' Diamond Control Teams requirements for the secure processing of diamondiferous material. This involves access control, surveillance, hands-off processing and diamond control in accordance with the South African Diamond Act No. 56/86. JDS is of the opinion that the security procedures and measures undertaken during the Gahcho Kué sampling programs are adequate.

SECTION 12 DATA VERIFICATION

JDS has reviewed Data Verification processes undertaken in the previous Technical Reports. JDS is of the opinion that the Data Verification is adequate for use in the Report. A summary of data verification from these reports is provided below. Independent data verifications were undertaken on a number of occasions between 1999 and 2012:

- 1999, 2004, 2007 – independent consultants made site visits to review quality assurance/quality control (QA/QC)
- 1999 – external consultant audit of the 1999 evaluation program
- 2000 – geology (petrological) peer review
- 2004 – geotechnical and hydrogeology consultants QA/QC site visit, internal and external mineral resource evaluation data base audits, geology (petrological) peer review, Gemcom® three-dimensional (3D) model peer review
- 2007 – internal and external petrological peer reviews; external verification of macro-diamond resource evaluation data set
- 2008 – external review of 2003 Technical Report resource estimation and density (rock density) models.
- 2012 – peer review of updated geological models and Mineral Resource estimates; external consultant reviews of geological solid models and zonal estimate for Tuzo Deep Lower.

Resource evaluation database verification included the following:

- audits of drill collar locations and lengths
- down-hole survey data
- geological logs
- bulk density data
- macro-diamond data.

Data storage and verification procedures are adequate to support the geological interpretations and mineral resource estimation. Data are stored digitally using appropriate database management software (Microsoft Access®), are being migrated into a diamond sampling workflow-based repository running on a SQL server located in Toronto, and are backed up periodically to ensure against loss of data due to failure of a single computer or hard drive. Original data are properly stored as paper and/or digital files with appropriate backups. Most paper files were scanned and stored digitally. The project database undergoes periodic internal verification as well as periodic audits by external reviewers.

SECTION 13 MINERAL PROCESSING & METALLURGICAL TESTING

13.1 Metallurgical Testwork

Mineral processing and metallurgical testing supports the mineral recovery and process plant design and was undertaken by ADP, Polysius and De Beers. Mineral processing and metallurgical test work undertaken on from the Gahcho Kué Kimberlites is summarised below. Hatch is of the opinion that the metallurgical testwork is adequate for use on the project.

13.1.1 2002

Sample and mineralization characteristics were evaluated from a combination of the 2002 ODS results, and suitable information from the treatment of the LDD chips at the De Beers Grand Prairie facility during the 2000 (5034, Hearne, Tuzo and Tesla) and 2001 (5034 and Hearne) Gahcho Kué evaluation programs. This included dense media separation (DMS) and granulometry data.

Examination of the DMS operating parameters indicates that data derived from the sample treatment plant are reliable. The information is summarised in Table 13.1 and 13.2.

Preliminary data from both the ore dressing studies (ODS) and the LDD chip processing indicated that the kimberlite has a low DMS yield that should result in easy DMS operations and a relatively small recovery plant. The fines content presented in Table 13.2 is the total amount of fines produced during both drilling and scrubbing operations. As such, this is not considered representative of the fines that would be generated in a production plant.

Table 13.1: Mineralization Characteristics 2000 (Summary)

Pipe	Density (g/cm ³)	Total % (-1.0 mm)	DMS Concentrate (% of DMS Feed)	X-ray Yield (%)
5034	2.59	49.8	0.40	3.10
Hearne	2.58	49.8	0.38	2.61
Tuzo	2.40	65.7	0.31	4.05
Tesla	2.39	58.0	0.2	2.23
Average	2.39	55.2	0.36	3.0

Table 13.2: Mineralization Characteristics 2001 & 2002 (Summary)

Pipe	Total %	DMS Concentrate (% of DMS Feed)	
	(-1.0 mm)	2001 Grande Prairie	2002 ODS (Theoretical Yield Ep = 0.08)
5034	42.5	0.42	0.03
Hearne	54.7	0.28	0.09
Average	46.7	0.37	Not Applicable

A significant amount of internal granite dilution can be expected at times. This could have an impact on liberation (granulometry) and result in accelerated wear.

The kimberlite content of the expected run-of-mine (ROM) feed based on these data is widely variable but on average is higher than 90%.

Information relating to the X-ray properties of diamonds was available from the evaluation programs and from the 2002 ODS. The ODS included magnetic susceptibility testing of the diamonds and gangue and the development of a luminescent profile of the gangue material. The recoverability of diamonds by X-ray sorting based on stones recovered during the evaluation programs, is summarised in Table 13.3. The number of stones larger than diamond sieve #12 was small, and the results were therefore biased toward the luminescence intensity (LI) values of the small stones. Generally, the large stones (>#12) showed good luminescence, while the smaller ones were more problematic. Recovery of small sizes would require very sensitive diamond sorting equipment, that is, the X-ray sorting equipment will need to be set at a lower than normal threshold setting, which could have an impact on diamond recovery.

Luminescence data obtained for the gangue material show that high yields can be expected when X-ray recovery technology is used to process DMS concentrate. Yields for the finer size fractions are estimated to be in the order of 0.3%. Excessively high yields can be expected for the coarser size fractions (+8 mm material). The data also showed that a yield in excess of 44% could be expected when processing material from certain areas of the kimberlite pipes. The actual diamond recovery may vary compared to the test work.

Table 13.3: Diamond Recovery Characteristics (Evaluation Programs)

Pipe	% Recovery at 0.25 Volts
5034	90.8
Hearne	94.3
Tuzo	90.3
Tesla	Not Applicable

Note: The 0.25 V is a threshold setting on an X-ray machine. When a diamond luminesces, the light is converted to an electrical signal, and if the signal is above 0.25 V the machine will eject the diamond and surrounding particles to the concentrate chute.

All the diamonds samples have a magnetic susceptibility less than $20 \times 10^{-6} \text{ cm}^3$ and thus could be recovered using high intensity magnetic separation. Magnetic susceptibility results showed that of the diamonds tested, 13% were diamagnetic and would not be recovered in using high intensity magnetic separation; thus, other methods are required to recover those stones. With the use of an NdFeB magnet, gangue mass reductions of up to 81.95% were measured.

13.1.2 2005

Testwork, as shown in Table 13.4, was completed from 2002 to 2005.

Table 13.4: Testwork Summary

Testwork Location	Tests Undertaken / Data Generated
Gahcho Kué LDD (Grande Prairie processing facility) Diamonds sorted at the GEMDL (South Africa)	Particle size distribution DMS concentrate yield Diamond recovery Diamond size distributions Granulometry
DebTech (South Africa)	Diamond and gangue luminescence Diamond and gangue magnetic susceptibility Recovery plant yield Drop weight data Slimes characterization Whole ore densimetric analysis Rock mechanics Preliminary scrubbing tests
Patterson and Cooke Consulting Engineers (South Africa)	Slime slurry rheology and pumping
Krupp Polysius (Germany)	High-pressure rolls crushing
Kawasaki (EarthTechnica, Japan)	Cone crushing

Testwork findings were as follows:

- Gahcho Kué kimberlites exhibit similar impact breakage to their associated granite rock. The impact breakage characteristic of these samples can be classified as medium to hard; therefore, crushers utilising higher input energies such as 1 kWh/t or higher may be required.
- Gahcho Kué material is resistant to comminution by abrasion as indicated by t_a values of 0.27 to 0.52, where t_a is the measure (index) of resistance to abrasion breakage. This indicates that a scrubber or a mill could be utilised as a ‘washer’ rather than a comminution unit.
- Laboratory scrubbing results indicated that comminution attributed to scrubbing would generate very low fines, less than 10%.
- Polysius testwork generated design data for application of a high pressure rolls crushing (HPRC) unit either in a secondary or tertiary crushing mode. The required product size for treating approximately 350 t/h of a mixture of plant feed (-50+30 mm) and DMS rejects (-30+6 mm) will be achieved by a truncated feed size at higher press force, 3.4 N/mm^2 and with specific energy of 3.0 kWh/t.

- EarthTechnica crusher testwork generated design and scale-up data for secondary crushing application using a Kawasaki type crusher. These data were generated for a blend of Hearne and 5034 samples. However, it was established that if these kimberlite bodies are treated separately it would result in similar trends within certain limits. This conclusion was based on the individual drop-weight tests (DWT) and rock mechanics results provided to their technical team by GTS Metallurgy.
- Three Kawasaki crusher options, such as KM3015Z, KM3682Z and KG4015Z, were investigated for scale-up.
- DMS yields should be relatively low, potentially less than 1%, for both 5034 and Hearne kimberlite bodies. The optimum split size based purely on the lowest calculated yield was found to be 8 mm. A split DMS was recommended for the conceptual Gahcho Kué process flowsheet.
- Co-thickening has benefit in terms of reagent consumption, water savings and generation of high-density slurry. A high density thickening unit with picket rakes would be necessary to assist with the compaction of the mud-bed to achieve higher-density slurry.
- The results from the ore dressing study showed that the Gahcho Kué material is similar to other kimberlites processed in Southern Africa with respect to comminution and densimetric profiling.
- Normal wear rates are expected for the processing of the Gahcho Kué material through standard diamond processing comminution devices such as cone and high pressure roll crushers. DMS yields can be classed as “medium to low” with less than 1% yield being obtained for both the 5034 and Hearne kimberlites.
- One problematic area that was identified by the ore dressing study was the large amount of luminescent material that reported to the DMS sinks fraction. This material was subsequently tested on a dual-wavelength X-ray machine to determine the probable yields that could be obtained from a production unit. Initial indications were that up to 90% of the luminescent gangue material could be rejected.
- High flocculant consumption rates were obtained for treatment of slimes where the grit fraction had been removed. Flocculant consumption for co-thickened slurries were approximately half that of the slimes only fraction.

13.1.3 2006

Conceptual use of grease recovery technology was explored during 2006. Grease technology was considered to have advantages over the earlier use of X-ray technology at Gahcho Kué because grease technology typically has:

- high efficiency, typically greater than 95% diamond recovery for -3 +1.5 mm material and 97% recovery for -6 +3 mm material
- low capital and operating costs
- low yields of 0.05% for -3 +1.5 mm material and 0.01% for -6 +3 mm material

- high throughputs, typically 500 kg/h for -3 +1.5 mm material and 1,000 kg/h for -6 +3 mm material
- small footprint
- fully enclosed for security of product.

The conceptual recovery plant designed in 2006 was based on grease recovery for -6 mm material and X-ray recovery for +6 mm material. To remove non-diamond material, degreased -6 mm concentrate was proposed to be chemically treated using hot molten caustic, and +6 mm X-ray concentrate to be hand-sorted.

13.1.4 2007

Samples of Gahcho Kué Tuzo gangue were characterised at DebTech for amenability to X-ray sorting and magnetic separation technologies. The samples were composed of material fractions, -8+3 mm and -3+1.18 mm. The respective size fractions were separately subjected to X-ray excited luminescence intensity, as well as mass magnetic susceptibility measurements.

Tuzo gangue was found to be amenable to X-ray sorting. Magnetic susceptibility data for the Tuzo drill core samples and diamonds indicate that magnetic sorting to reduce the feed to recovery can be applied.

13.1.5 2011-2013

A review of all testwork completed was undertaken by De Beers Technical Services to establish the final design criteria for the process plant design.

13.2 Process Plant Design

A plant design was prepared to support cost estimates. The design assumes conventional diamond processing techniques, and a process flowsheet comprising:

- primary and secondary crushing
- scrubbing and screening of the crushed product
- size separation of cleaned material based on density
- diamonds recovered using grease technology and X-ray sorting
- fines and coarse rejects disposal.

SECTION 14 MINERAL RESOURCE ESTIMATES

14.1 Introduction

The baseline estimation and classification of the mineral resources was completed by AMEC, summarised in the “Gahcho Kué Kimberlite Project NI 43-101 Technical Report” (AMEC 2009). Additions / modifications to the AMEC mineral resource for the Tuzo Deep mineral resources deeper than 300 metres below surface (mbs) elevation are summarised in the “Update of the Mineral Resource Estimate for the Tuzo Kimberlite, Gahcho Kué Project, Northwest Territories, Canada NI 43-101 Technical Report” (Mineral Services 2013) as a result of an additional ‘Tuzo deep’ drilling program undertaken in 2012.

JDS has reviewed both the (AMEC, 2009) and (Mineral Services, 2013) resource statements and has compiled the information into a single resource estimate table for the Report. JDS is of the opinion that the resource estimates presented in Table 14.28 provide an accurate and complete basis for the feasibility study.

The databases were constructed and maintained in the Gemcom® modelling system. Geological models were constructed using Gemcom® modelling tools. Mineral resource estimations were carried out in both Gemcom® software and Isatis®. Open-pit shells for use in resource declaration were developed in Whittle® using the Lerchs-Grossman open-pit optimization algorithm.

LDD was used to collect samples of kimberlite for grade and diamond value modelling. Macro-diamonds³ from the LDD were used to estimate local grades on 5034 West and Centre lobes and Hearne Pipe. Grade estimations for these pipes were completed using variography and kriging methods. Diamonds from this drilling were also used to confirm diamond size and value data for all lobes and pipes.

Micro-diamonds⁴ from drill core were used to create local estimates of grade for the 5034 North-East Lobe and Tuzo Pipe. Micro-diamonds are stones (less than 0.5 mm) recovered from the dissolution of drill core using a caustic fusion process. These results were used for local estimation (kriging) into blocks (25 m x 25 m x 12 m) and then converted to carats per hundred tonnes above a commercial

(3) Macro-diamonds for the purposes of this report are those stones recovered from LDD samples by a treatment process that involves crushing and screening.

(4) Traditionally, stones retained on a 0.5 mm square-mesh screen after sieving are referred to as macro-diamonds, while stones that pass through the sieve are referred to as micro-diamonds. For the purposes of this report, micro-diamond results refer to stones recovered from diamond drill core subjected to acid digestion or caustic fusion. Strictly speaking, these results may contain both micro- and macro-diamonds. The micro-diamond treatment process involves dissolving the kimberlite in an acidic or caustic solution and recovering any diamonds released above a specified bottom cut-off (usually 75 µm or 106 µm). The micro-diamond results can be used to estimate the grade in carats per hundred tonnes (cpht) of a kimberlite above a given cut-off. Estimates of grade using micro-diamonds must be adjusted to reflect a realistic bottom cut-off (e.g., 1.0 mm), and may need adjustment to reflect differences in liberation and recovery in a commercial treatment plant and the micro-diamond treatment process.

bottom cut-off using a micro–macro model of grade as a function of size. Micro-diamonds were used in these cases primarily due to the difficulty of obtaining adequate macro-diamond samples for the purposes of local resource block estimation. In these cases, the available macro-diamonds were used for valuation purposes and for calibration of micro-diamonds models.

Micro-diamonds from drill core were used to create global estimates of grade for the 5034 North and South pipes. Zonal estimates of grade (grade/rocktype) were completed in 2013 for Tuzo Deep.

Density modelling was completed using dry bulk densities. Density was estimated per lobe for 5034 West and Centre, locally into mining blocks for the 5034NE Lobe, by rock type for Hearne Pipe, and locally into mining blocks for Tuzo Pipe.

Appropriate techniques were used to ensure calculation and reporting of the diamond mineral resource at a +1 mm lower cut-off. The mineral resource was adjusted appropriately for expectation of main treatment plant recoveries.

To establish a reasonable cut-off grade and assess reasonable prospects for economic extraction to support declaration of the mineral resources, average diamond pricing was applied to the resource, and Whittle® software was used to establish a series of pit shells. Material outside of the selected pit shell was also considered with respect to potential underground extraction.

14.2 Mineral Resource Estimation

14.2.1 GEOLOGIC MODELS & ESTIMATION DOMAINS

The following sections briefly discuss the geologic models as they relate to the estimation of the resource grades.

14.2.1.1 5034

The 5034 Pipe is composed of four joined kimberlite bodies, referred to as “lobes” and two small satellite pipes (North and South pipes; see Figure 7-5). In plan view the West, Centre and East lobes have irregular, but roughly circular shapes of approximately 80 m diameter. The North Lobe is comprised of a 35 m wide dyke-like protrusion, which extends from the East Lobe 300 m to the north–northeast. The North Lobe lies under a cap of 70 m to 80 m of granite, which is likely to be in situ. In this report, the North and East lobes were treated as one lobe, the North-East Lobe, for the purposes of mineral resource estimation.

The North-East and West lobes exhibit a layered internal structure with kimberlite gradually changing texture from coherent hypabyssal kimberlite (HK) at depth to a fragmental tuffisitic kimberlite (TK) at shallower levels. In contrast to the layered structure of most lobes, the Centre Lobe is composed exclusively of HK, which cannot be subdivided using petrological or geochemical means. The hypabyssal kimberlite found in all four lobes is geochemically and petrologically very similar, suggesting a close genetic relationship of all four lobes.

14.2.1.2 HEARNE

The Hearne kimberlite consists of two pipes, North and South, and comprises a mix of HK and TK. The North Pipe is elongate with an approximate near-surface 55 m width and 215 m length. The South Pipe is roughly circular with a near-surface diameter of 90 m. Each TK kimberlite can be distinguished geologically based on garnet content, magma clasts, autolith-like bodies, xenoliths, and clay minerals. The names of the different TK units are based primarily on their location within the two pipes. The HK kimberlites represent the transition from diatreme to root zone and are differentiated largely based on garnet content and grade.

14.2.1.3 TUZO

Tuzo Pipe covers 1.27 ha at surface, measures approximately 115 m x 110 m in plan, and is overlain by lake-bottom sediments, glacial overburden, and the waters of Kennady Lake. The pipe is circular at surface, but widens at depth, resulting in an unusual inverted conical shape.

For the purposes of mineral resource estimation, one of the fragmental units (TKTKT1) was subdivided into a high-grade and a lower grade portion using macro grade information from LDD samples taken in 1999 and 2008.

The High-Grade zone was originally identified in 1998 from LDD data due to a zone of higher macro-diamond grade. Subsequent logging and re-logging of existing core suggested overall slight petrographic differences between the “High-Grade” zone and the adjacent “Low-Grade” area, but also considerable textural inhomogeneities within the High-Grade zone itself. A possible scenario to explain these features is that the High-Grade zone is a feeder conduit that has collapsed and mixed on a grain-by-grain basis with the surrounding tephra of the TK unit.

Although not an ideal approach, it is relatively common industry practice to isolate a high-grade zone in this manner where it is recognised that to not do so would cause undue spreading of the anomalous (high into low, low into high or both) grade during an interpolation. In this case, the approach is preferable, particularly where the data available are insufficient in number to risk potential over-projection of high-grade samples.

The Tuzo Deep program resulted in the extension of the geological model to a depth of 564 mbs. Of the main kimberlite types identified in the Tuzo upper, only two main types (Hk and TKt) extend below 300 mbs. The TKt unit is volumetrically dominant representing 59% of the Tuzo deep model and represents transitional kimberlite that has been demonstrated to be geologically continuous with the TKT2 domain modelled in Tuzo Upper (Mann, 2013). HK makes up approximately 24% of the Tuzo Deep geological model. It has been demonstrated to be continuous with and, for the most part, geochemically and mineralogically similar to the HK occurring in Tuzo Upper (Mann, 2013). In addition to the main kimberlite types, the granite breccia/xenolith zone (granite “Raft”) modelled in the lower portion of Tuzo Upper extends into the upper portion of Tuzo Deep. This, together with a marginal zone of country-rock breccia (with minor kimberlite; referred to here as CRXBX) and large blocks of granite modelled as separate solids (CRX), are included in the geological model, but for the purpose of

Mineral Resource estimation are classified as internal waste. Waste units comprise approximately 17% of the Tuzo Deep geological model. The solids for the TKt, HK and CRXB domains have been subdivided at 360 mbs for the purpose of Mineral Resource estimation.

14.2.2 GRADE ESTIMATION - 5034 WEST & CENTRE LOBES

14.2.2.1 ESTIMATION APPROACH

For the West and Centre lobes of 5034, local block estimates were created within a 3D block model using the macro-diamonds recovered from LDD. Grade was first estimated locally in carats per cubic metre (ct/m³) and then converted to cpht by applying a global density for each lobe (grade in cpht is obtained by dividing grade in ct/m³ by density and multiplying by 100).

14.2.2.2 LARGE DIAMETER DRILLING DATA (MACRO-DIAMOND DATA)

The 1999 LDD holes were drilled using a drill bit diameter of 12.25" over 18 m lifts: the 2001 and 2002 drilling used a 24" drill bit diameter over 6 or 12 m lifts. Table 14.1 summarizes the holes located in the West and Centre lobes, and Table 14.2 summarizes the sample statistics by lobe. Both tables have a bottom cut-off at 1.5 mm including incidentals.

Table 14.1: 5034 West & Centre Raw LDD Data

Hole ID	Location X	Location Y	Location Z	Depth (m)	Volume (m ³)	Carats	Stones (No.)
MPV-99-01L	589231.79	7035426.62	394.47	75.00	4.198	19.050	171
MPV-99-02L	589249.29	7035423.62	386.82	219.70	15.944	81.665	1,089
MPV-99-03L	589274.79	7035431.62	395.87	263.10	19.921	92.195	1,277
MPV-99-04L	589297.79	7035430.62	396.02	281.10	20.864	100.895	1,210
MPV-99-05L	589324.79	7035386.62	399.37	237.10	17.341	60.160	630
MPV-99-06L	589321.79	7035371.62	395.37	203.50	14.802	38.455	567
MPV-99-07L	589341.79	7035369.62	399.57	209.10	15.289	31.365	403
MPV-99-08L	589359.79	7035362.62	399.92	208.50	15.485	52.530	644
MPV-02-081L	589318.91	7035387.49	399.27	190.20	51.668	137.215	1,462
MPV-02-086L	589317.99	7035376.18	398.60	192.27	52.128	109.575	1,191
MPV-02-088L	589281.77	7035429.16	395.40	259.50	75.514	414.020	3,961
MPV-02-089L	589282.58	7035422.64	386.25	206.76	58.303	243.430	2,578
MPV-02-090L	589313.67	7035384.07	399.94	167.40	44.476	123.370	1,462
MPV-02-102L	589276.67	7035425.08	386.32	151.59	41.428	179.735	1,879

Table 14.2: Raw Sample Data Statistics

Rock Type	Code	1999		2001 & 2002		All	
		No.	Avg. ct/m ³	No.	Avg. ct/m ³	No.	Avg. ct/m ³
5034 W Lobe	101	44	4.8	42	5.3	86	5.0
5034 C Lobe	107	57	3.3	48	2.6	105	3.1

14.2.2.3 OTHER CONSIDERATIONS IMPACTING GRADE DETERMINATION

A number of other issues were considered prior to the grade estimation of 5034 West and Centre lobes:

- The effect of different sample-support sizes of the two LDD programs. Different sample support sizes (in this case, 311 mm and 610 mm diameter LDD drill holes) tend to result in similar grade means, but different grade variances: the larger support size has a smaller variance. A technique to adjust the sample variance of the smaller diameter holes was considered in 2003, but was not applied due to inconsistent results. In this report, as in 2003, no adjustment was made for different hole diameters.
- The effect of different sample lifts, namely 6 m, 12 m, and 18 m. The issue of different sample lifts was resolved by regularization, a process that calculates the grade per mining bench height by combining or sub-dividing samples into common lengths and weight averaging the diamond content over the new interval. For Gahcho Kué, a bench height of 12 m was planned, and grade values were drill-hole length weighted according to the drill-hole intersection per bench to accommodate sample lengths that varied from less than 12 m to greater than 18 m.
- The impact of clustering of the 2002 drill holes. To test the effect of the clustered LDD samples on the mineral resource estimates, a de-clustering method was tested but not applied for two reasons. Only small differences were found between global grades using de-clustered data and clustered data, and the semi-variograms indicated that the correlation between sample points was preferentially orientated in a vertical rather than horizontal direction.
- Assess the diamond recovery differences between campaigns. Results from different campaigns exhibited differences in recovery characteristics, which were related to reasonably well understood drilling conditions.

14.2.2.4 COMPOSITE PREPARATION (CP)

The adjusted sample macro data were imported into Gemcom® where they were bench composited to 12 m lengths while honouring geology. The cut-off for the minimum length of composites to be used in the estimation was investigated by comparing the average cp/m^{3*} value of composites at several cut-offs to ensure there was no bias in the selection of composite length. The difference in the average cp/m^3 value between all composites, and those where bottom cut-offs were applied, is negligible. To maximize the use of available grade information, a minimum length of 6 m was imposed.

14.2.2.5 HISTOGRAMS & UNIVARIATE STATISTICS

Histograms and probability plots of the 12 m bench composites were generated for each rock type containing macro data. Summary statistics are shown in Table 14.3 at a bottom cut-off at 1.5 mm including incidentals.

Table 14.3: 5034 Composite Statistics by Rock Type

Rock Type	Rock Code	No.	Avg. cp/m ³ *	CV
5034 W Lobe	101	102	4.843	0.324
5034 C Lobe	107	130	2.805	0.559

* Bottom cut-off at 1.5 mm includes 9% incidentals in 5034

14.2.2.6 VARIOGRAPHY

Grade variography was conducted on the 12 m bench composites for each lobe in 5034. Experimental correlograms were calculated and modelled using Sage2001®. Directional correlograms were generated using a 20 m lag: the vertical correlogram is based on a lag spacing of 12 m. Greatest continuity is in the down-dip direction for all rock units. For the 5034 Pipe, this equates to the vertical orientation of the holes.

14.2.2.7 LOCAL GRADE ESTIMATION

A 25 m x 25 m x 12 m block model project was defined in Gemcom®. Ordinary block kriging was performed for each by a kriging estimator using two passes. Search ellipses were orientated in the direction of continuity as defined by the correlograms. In Pass 1 for 5034, the search radii were 75 m x 75 m x 50 m in the X, Y and Z directions, respectively. In Pass 2, search radii were increased to allow all blocks within the model to be assigned a grade. Validation of the mineral resource estimate included a visual inspection, comparison of statistics, and analyses to detect spatial bias and excessive smoothing. Table 14.4, at a bottom cut-off at 1.5 mm including incidentals, shows the percent difference between the kriged and nearest-neighbour (NN) block estimates are typically less than 5% for any given rock type.

Table 14.4: Comparing Kriged & NN Estimates by Rock Type

Rock Type	Code	Composites			Kriged Estimates			NN Estimates			% Diff = (KRG-NN)/NN
		No.	Avg. cpm ³	CV	No.	Avg. cpm ³	CV	No.	Avg. cpm ³	CV	
5034 W Lobe	101	102	4.8	0.324	357	4.8	0.102	357	4.9	0.345	-3.0
5034 C Lobe	107	130	2.8	0.559	295	2.8	0.310	295	2.9	0.513	-3.6

⁴ Bottom cut-off at 1.5 mm includes 9% incidentals in 5034

14.2.2.8 DENSITY MODEL

The 2003 Mineral Resource estimate applied an in-situ (wet) density, rather than a standard dry density, due to the limited number of dry density measurements available. In this update, dry density was used where available. Where too few dry measurements were taken, available in-situ density measurements were converted to a dry density. The average dry densities by lobe were calculated for the Centre and West lobes and applied to the mineral resource model (Table 14.5).

Table 14.5: Calculated Dry Density by Rock Type

Rock Type	Dry Density (g/cm ³)
W Lobe	2.34
C Lobe	2.66
5034 South	2.40
5034 North	2.58
HNTKN	2.22
HNTKNT	2.34
HNHKN	2.63
HNTKG2	2.37
HNHKG2	2.68
HNTKSD	2.22
HNHKG	2.65
HSTKM	2.21
HSTKW	2.22
HS_UNDEF	2.21

14.2.3 GRADE ESTIMATION – 5034 NORTH-EAST LOBE

14.2.3.1 ESTIMATION APPROACH

De Beers and other companies have used micro-diamond sampling to estimate diamond grade in kimberlites for some time. In almost all cases, the approach was to estimate grade globally or per lithofacies. For the North-East Lobe, the estimation of global grade using micro-diamonds was extended to allow the estimation of local block grades. This was achieved by combining models of stone density and diamond size distribution data and by estimating stone density rather than carat grade locally. Calibration and consistency of the models was achieved using macro-diamonds.

This method was considered particularly apt for the North Lobe, which lies below 60 m of granite that has proved difficult to penetrate using large diameter drilling (the conventional approach to kimberlite grade estimation). In addition, the inclined nature of the North Lobe limited the amount of sampling that could be achieved from vertical holes. The use of micro-diamond sampling provided a practical method of estimating grade.

The estimation approach is summarised as follows:

- The North-East Lobe was evaluated by means of micro-diamond sampling with confirmation of macro-diamond size distributions from LDD on the East and North lobes, respectively.
- The lobes were first evaluated individually in terms of their litho-facies.
- The two lobes were then combined, and a global diamond content was estimated for each litho-facies where the North and East lobes were treated as one unit (the North-East Lobe).

- Diamond content was estimated on the basis of micro-diamond and macro-diamond sampling. Micro-diamond samples comprised 8 kg samples from fixed lengths of core at regular intervals down-the-hole with diamond recovery above 0.074 mm. Macro-diamonds were recovered from LDD and LDC samples with recovery above a 1.5 mm (LDD) and 1 mm (LDC) bottom cut-off.
- A spatial model for density was constructed for the calculation of block tonnages.
- The global diamond content was proportioned into the local resource blocks (25 m x 25 m x 12 m) on the basis of the spatial distribution of micro-diamond sample stone counts (stone densities).

14.2.3.2 SAMPLE DATA

A total of 200 micro-diamond samples, each weighing approximately 8 kg, were collected from 11 core drill holes drilled into the North Lobe, amounting to some 1,615 kg of sampling material. From the East Lobe, 107 samples were collected from five core holes with samples comprising an average of 8.1 kg from an average core length of 3.1 m. This program yielded a total sample weight of 866 kg.

Table 14.6 is a summary of the core drill holes treated for micro-diamonds used in this analysis, showing summary depths with recovered stones and carats from 5034 East and North lobes.

In order to eliminate irregular recoveries in the very small size classes and to facilitate better comparison, it was decided to work with stone counts and stone density above the De Beers micro-diamond size class md6, which represents diamonds larger than 0.00003 cts. Diamond density was expressed in terms of stones per 10 kg.

A further breakdown of micro-diamond sampling results by lobe and litho-facies is shown in Table 14.7. One drill hole intersected the North Pipe, and with the results for these samples similar to HK from North and East lobes, it was decided to include its samples in the analysis.

Table 14.6: Core Holes for Macro-diamonds from 5034 North & East Lobes

Hole ID	From (m)	To (m)	Sample weight (kg)	Consignment	Lobe	Stones total	Stones +md6	Stones / 10 kg	Stones 10 kg +md6	Carats total
MPV-07-296C	29.4	310.3	177	CAN070177	East	1,694	755	95	43	0.9397
MPV-07-294C	26.2	225.2	137	CAN070180	East	866	371	63	27	0.3361
MPV-07-298C	17.6	295.7	179	CAN070199	East	1,590	616	89	34	1.0202
MPV-07-303C	18.1	276.0	171	CAN070210	East	1,745	777	102	46	1.1861
MPV-07-305C	18.1	307.2	203	CAN070233	East	2,176	922	107	45	1.5364
			866			8,071	3441	93	40	5.0185
MPV-05-242	66.9	296.8	193	CAN060012	North	1,769	756	92	39	1.1375
MPV-05-239	180.7	322.8	121	CAN060015	North	1,134	451	94	37	0.6572
MPV-05-241	84	404.8	193	CAN060018	North	961	588	50	30	2.1683
MPV-05-244	55.9	305.8	201	CAN060022	North	1,150	683	57	34	0.8002
MPV-05-243	69.8	345.3	226	CAN060026	North	1,000	609	44	27	1.3368
MPV-05-245	70.6	344.5	193	CAN060030	North	1,241	759	64	39	0.9514
MPV-05-234	122.0	222.2	89	CAN060034	North	780	468	88	53	0.5023
MPV-05-260	305.7	341.9	40	CAN060083	North	232	145	57	36	0.1231
MPV-05-261	300.8	358.3	57	CAN060087	North	295	184	52	32	0.1149
MPV-05-258	60.4	358.4	253	CAN060122	North	1,445	899	57	36	1.2024
MPV-05-275	152.7	200.5	49	CAN060125	North	276	158	56	32	0.2504
			1,615			10,283	5700	64	35	9.2446

Table 14.7: 5034 North & East Lobe Micro-diamond Sampling Results per Litho-facies

Lobe	East				North					
	HK	HKT	TKT	Total	HK HKT					
Sample wt(kg)	583.1	186.2	97.1	866.4	928.6	395.3	88.6	145.6	56.8	1614.8
Dilution %					13	15	32	20	13	15
Undiluted Kg	583.1	186.2	97.1	866.4	809.5	336.8	60.3	116.7	49.2	1372.6
Stones	4802	2396	873	8071	5515	3241	409	823	295	10283
carats	3.2012	1.4106	0.4067	5.0185	5.5683	2.2146	0.4551	0.8917	0.1149	9.2446
Stones (+md6)	2040	1057	344	3441	2941	1820	254	500	184	5700
Stones/10kg (+md6)	35	56.8	35.4	39.7	31.7	46	28.7	34.4	32.4	35.3

14.2.3.3 DIAMOND SIZE DISTRIBUTION MODELLING

Individual size distributions for micro-diamond samples were plotted and compared with other samples from the same litho-facies to observe sample variability and to eliminate possible outliers. No samples were identified as outliers. In addition, samples were plotted and combined by hole and litho-facies to compare drill hole results.

Sample diamond-size distributions were compared by lobe and lithofacies (North and East Lobe data were kept separate) and by lithofacies for the North and East lobes together. The plots showed that the smaller TKT sample totals from the East and North lobes were more variable and the North Lobe TKT indicated a coarser diamond size distribution than the other litho-facies, while TKT from East lobe

indicated exactly the opposite. Combining the two sets of TKT samples resulted in a size distribution similar to the other lithofacies.

This final comparison by litho-facies between the North Lobe and East Lobe suggests that the litho-facies all have a similar diamond size distribution. The observation of a similar diamond size distribution for all the litho-facies in North and East lobes supports the idea of geological continuity from the East to the North lobe.

Macro-diamond results were subsequently plotted for the different litho-facies to ascertain if the suggestion of a similar overall diamond size distribution was also evident on the basis of macro-diamond sampling results. In this comparison the North Lobe LDC sampling results were plotted, along with the LDD results for East Lobe.

These plots exhibit a similarity of macro-diamond size distributions and further confirm the observed geological continuity between the East Lobe and the North Lobe.

Size distribution modelling was concluded by obtaining the (log-normal) statistical parameters from the sample diamond size distributions. Diamond size distribution modelling was done iteratively by creating a diamond “parcel” based on the modelled diamond size distribution, with an iteration comprising two million “samples,” which were combined to form the diamond parcel.

The results were plotted on one graph showing the micro- and macro-diamond sampling results. The process was repeated until both micro- and macro-diamond sample results were satisfactorily replicated.

In view of the common diamond size distribution for all litho-facies, it was concluded that differences in diamond content between litho-facies and between North and East lobes would be attributed to differences in diamond density (stone density) and that the spatial variability of diamond density would have to be established in order to estimate diamond content in resource blocks.

14.2.3.4 DIAMOND DENSITY DISTRIBUTION (STONES PER 10 KG) MODELLING

Micro-diamond samples were analysed per litho-facies to obtain diamond density (concentration) models required for grade modelling.

In view of the similarity in stone counts between the TK and TKT lithofacies, it was decided to group these samples for modelling. This also increased the number of samples available for the procedure. Furthermore, GKJV concluded that North Lobe and East Lobe HK samples could be combined, as was the case for North Lobe and East Lobe HKT samples and for all the TK and TKT samples from North Lobe and East Lobe.

14.2.3.5 ESTIMATION OF GLOBAL DIAMOND CONTENT PER LITHOFACIES

Global diamond content was estimated by creating a “diamond parcel” for the litho-facies under consideration. This diamond parcel was based on the modelled diamond size and diamond density distributions (see above).

The diamond parcel was generated by simulating two million samples using the model attributes for diamond size and diamond density. A Monte Carlo simulation was then used to construct a diamond parcel as follows:

- A sample stone density is drawn at random from the modelled stone density distribution.
- The stones in this sample are assigned a weight by randomly drawing from the modelled diamond size distribution.
- The stones and weights from each draw are accumulated.
- The simulation is repeated until the required number of samples was drawn resulting in a “diamond parcel.”

The parcel stones were allocated to size classes and presented in the form of log-probability and grade-size⁵ curves. Diamond data for the corresponding micro- and macro-diamond sample parcels were plotted with the simulated parcel curves for comparison. Global estimates of grade were prepared for units HK, HKT and combined TK and TKT based on the simulated parcels.

The grade estimates prepared this way represent the total diamond content. This means that the estimates include stones that would not usually be recovered after treatment in a conventional production treatment plant. Such grades are therefore optimistic relative to what will be achieved in a conventional treatment plant and require adjustment. The global grades for the two lobes combined are shown in Table 14.8.

Table 14.8: Zonal Diamond Content for 5034 North-East Lobe

Items	North & East Lobe HKT		North & East Lobe HK		North & East Lobe TK & TKT	
	+5ds (cpht)	+2ds (cpht)	+5ds (cpht)	+2ds (cpht)	+5ds (cpht)	+2ds (cpht)
No incidentals	200	289	142	206	143	207

Note: Total content grades are given in carats/100 t at +5 and +2 ds, (effectively +1.5 mm and +1.0 mm). Content derived from grade-size models from sampling data for the combined lobes.

(5) One way to view micro-diamond data (and estimate a grade) is to plot the micro-diamond results for a given kimberlite facies on a grade-size graph. In such a graph, the average size of the micro-diamonds in a particular sieve size is plotted on the X-axis, and the “grade” of the sieve class in stones per tonne is plotted on the Y-axis. If the data are plotted using a log-log scale, a polynomial can be fitted to the data points and the grade of the kimberlite above a bottom cut-off calculated by measuring the area under the fitted curve. The relative position of the fitted curve on the plot is indicative of kimberlite grade, while the curvature of the fitted line reflects the diamond size distribution.

14.2.3.6 SPATIAL ESTIMATION OF STONE DENSITY & PROPORTIONING OF THE GLOBAL DIAMOND CONTENT

A spatial model for micro-diamond stone density was created to obtain a spatial model and local estimates for macro-diamond grade in carats/100 tonnes. Local estimates for stone density were calculated by means of kriging. This process involved a spatial analysis per litho-facies to obtain spatial structure for stone density, followed by the kriging process.

Variograms were modelled for units HK and HKT combined for the two lobes and kriged using the combined micro-diamond sample stone densities. A range of 60 m and a nugget effect of around 50% of the sill were used with a kriging neighbourhood of 75 m in all directions for HK and HKT, applying ordinary kriging in all cases. For the sparser sampled TKs, a unique kriging neighbourhood was used.

By using calculated block tonnages and kriged block stone density the corresponding block stones were calculated and accumulated to total stones for each litho-facies. To obtain block carat estimates at a given bottom cut-off, the corresponding total carat estimate for the unit (zone) was apportioned into resource blocks in the ratio of block stones to total stones for the unit.

Table 14.9 is a summary of global grades at +5 ds derived from block carat estimates per litho-facies and lobe, after localising zonal diamond content.

Table 14.9: Estimated Zonal Grades for Gahcho Kué 5034 North & East Lobes

Lobe	Rock	Sample Grade (cpht, +5ds)	Zonal Estimate (cpht, +5ds)
East	HK	126	147
	HKT	155	207
	TKT	169	156
North	HK	105	140
	HKT	203	197
	TK	156	128
	TKT	146	144

14.2.3.7 BULK DENSITY MODEL

Spatial analyses were performed using dry density per unit for the combined lobes. Bulk densities for blocks were estimated using a kriging estimator. Table 14.10 shows reasonable comparisons between estimated blocks and sample data.

Table 14.10: Sampled & Estimated Dry Density for Gahcho Kué 5034 North & East Lobes

Density data by lobe & rock type				Used for kriging in Isatis® (spatial selection into litho facies by zonal polygons)				Kriged Result	
			In Situ	Dry Bulk		In Situ	Dry Bulk		Dry
Lobe	Rock Type	No. Samples	Density (g/cm ³)	Density (g/cm ³)	Number Samples	Density (g/cm ³)	Density (g/cm ³)	Number Blocks	Density (g/cm ³)
North	HK	164	2.63	2.58	151	2.65	2.60	406	2.58
North	HKT	84	2.54	2.44	77	2.55	2.46	262	2.46
North	TK	16	2.31	2.08	18	2.32	2.10	86	2.10
North	TKT	19	2.35	2.15	21	2.36	2.16	169	2.18
East	HK	46	2.73	-	56	2.72	2.69	286	2.65
East	HKT	15	2.61	-	21	2.58	2.49	103	2.47
East	TKT	-	-	-	6	2.52	2.42	76	2.35
East	Not Coded	18	2.63	2.55					
Not Coded	Granite	87	2.60	2.56					
North Pipe	HK	11	2.57	2.51					

14.2.4 GRADE ESTIMATION - HEARNE

14.2.4.1 ESTIMATION APPROACH

For the Hearne Pipe, local block estimates were created within the 3D block model using the LDD results. Estimates were constructed for 12 m benches across the entire pipe.

14.2.4.2 LARGE DIAMETER DRILL DATA (MACRO-DIAMOND DATA)

Similar to the drilling on 5034 West and Centre lobes, the 1999 LDD holes were drilled using a drill bit diameter of 12.25" over 18 m lifts: the 2001 and 2002 drilling used a 24" drill bit diameter over 6 m or 12 m lifts. Table 14.11 summarizes the holes located in the Hearne Pipe. There are no macro-diamond data for rock units HNTKG2 AND HS_UNDEF.

14.2.4.3 OTHER CONSIDERATIONS IMPACTING GRADE DETERMINATION

Hearne macro-diamonds are impacted by the same considerations presented for the LDD data from 5034 West and Centre lobes.

14.2.4.4 COMPOSITE PREPARATION

Hearne composites were prepared in the same manner as the composites for 5034 West and Centre lobes.

Table 14.11: Hearne Raw LDDH Data

Hole-ID	Location X	Location Y	Location Z	Depth (m)	Volume (m ³)	Carats	Stones (No.)
MPV-99-37L	588381.79	7034806.62	395.815	203	19.294	93.745	1391
MPV-99-38L	588367.79	7034806.62	305.82	173	5.259	25.835	352
MPV-99-39L	588392.79	7034921.62	396.195	299	22.324	94.565	1065
MPV-99-40L	588380.79	7035041.62	395.895	299	23.076	101.320	1126
MPV-99-41L	588387.79	7034961.62	396.72	257	19.310	68.770	730
MPV-99-42L	388385.79	7035001.62	394.07	288.8	21.514	77.720	976
MPV-99-44L	588385.79	7035021.62	395.22	294	22.046	87.785	969
MPV-99-45L	588390.79	7034941.62	392.2	155.2	13.621	63.890	1262
MPV-99-46L	588365.79	7035061.62	397.32	285.2	26.012	179.135	2941
MPV-99-47L	588392.79	7034901.62	394.82	203.2	17.640	48.445	724
MPV-01-057L	588366.04	7035065.45	397.895	159.44	43.900	242.755	2657
MPV-01-058L	588389.98	7035037.37	395.07	189.3	50.190	281.880	3139
MPV-01-060L	588376.57	7035054.86	396.885	150.79	40.790	223.110	2462
MPV-01-091L	588391.33	7034881.68	396.775	267.8	73.284	172.320	1663
MPV-01-099L	588382.84	7034998.17	386.62	225.7	57.940	258.470	2560
MPV-01-101L	588380.84	7035031.80	395.165	186.6	49.656	281.855	2871
MPV-01-103L	588386.14	7034991.63	393.92	154.04	40.640	227.710	2448
MPV-01-105L	588378.17	7034992.65	394.57	159.86	42.168	221.210	2378

Note: Bottom cut-off at 1.5 mm including incidentals.

14.2.4.5 HISTOGRAMS & UNIVARIATE STATISTICS

Histograms and probability plots of the 12 m bench composites were generated for each rock type containing macro data. Table 14.12 summarizes the statistics by rock type.

Table 14.12: Hearne Composite Statistics by Rock Type

Rock Type	Rock Code	No.	Avg. cpm ³	CV
HNTKN	200	47	5.9	0.178
HNTKNT	201	96	5.4	0.179
HNHKN	202	17	4.9	0.320
HNHKG2	204	19	3.9	0.417
HNTKSD	205	11	6.4	0.271
HNHKG	206	74	1.4	0.755
HSTKM	207	16	4.2	0.299
HSTKW	208	4	4.8	0.101

Note: Bottom cut-off at 1.5 mm including incidentals.

There are limited data available to analyze the Hearne rock types. HNTKN and HNTKNT exhibit higher grades and illustrate normal distributions: HNHKG contains low-grade material with a positively skewed distribution. Remaining Hearne units do not have sufficient data to make an informed comment.

Units with limited data are difficult to model and are grouped with units with similar statistical behaviour, specifically grade. Four rock groups were created for Hearne Pipe based on geology, location and grade:

- high-grade tuffisitic (TK_HG) – HNTKN (200), HNTKNT (201), HNTKSD (205)
- medium-grade hypabyssal (HK_MG) – HNHKN (202), HNHKG2 (204)
- medium-grade tuffisitic (TK_MG) – HSTKM (207), HSTKW (208)
- low-grade hypabyssal (HK_LG) – HNTKG (206).

14.2.4.6 VARIOGRAPHY

Grade variography was conducted on the 12 m bench composites for each rock group as defined above. For the Hearne units, maximum continuity is down dip following the interpreted dip direction of the rock units. Defined correlogram models were imposed on rock units demonstrating limited structure due to insufficient data. Experimental correlograms with limited data were modelled with structures of a group with similar grade. The correlogram model for Hearne TK_HG group was imposed on the Hearne HK_MG group with a slight modification to the range in the Z direction. The model for Hearne HK_LG group was imposed on the Hearne TK_MG group.

14.2.4.7 LOCAL GRADE ESTIMATION

A 25 m x 25 m x 12 m block model project was defined in Gemcom®. Ordinary block kriging was performed for each lobe, and the kriged estimates were validated globally and locally by a NN model generated for each lobe.

Ordinary block kriging was performed for each rock type with the exception of HS_UNDEF. The kriged estimates were validated by a nearest-neighbour (NN) model generated for each rock type. Soft boundaries between rock types within the same rock group were imposed.

Solid models exist for two Hearne rock units that have no macro data, HNTKG2 and HS_UNDEF. HNTKG2 sits just below the overburden surface in the south of Hearne North. As a result of its position in relation to Hearne South and its commonality in rock units (tuffisitic), HNTKG2 is estimated using HSTKM and HSTKW data and TK_MG estimation parameters.

Kriging was performed using two passes. The Hearne search strategy follows the strategy of mining bench-by-bench due to the slender north-south striking nature of the body. Search radii reaching the north-south and east-west extents aimed to include all allowable composites within a limited number of surrounding benches. Search radii are dependent on rock type for both passes. In the second kriging pass, search radii were increased to allow all blocks within the model to be assigned a grade.

Validation of the mineral resource estimate included a visual inspection, comparison of statistics, and analyses to detect spatial bias and excessive smoothing. Table 14.13 and 14.14 show the percent difference between the kriged and NN block estimates for rock type and rock group.

Table 14.13: Hearne Kriged & NN Estimate Comparison by Rock Type

Rock Type	Code	Composites			Kriged Estimates			NN Estimates			% Diff = (KRG-NN)/NN
		No.	Avg. cpm ³	CV	No.	Avg. cpm ³	CV	No.	Avg. cpm ³	CV	
HNTKN	200	47	5.865	0.178	101	5.580	0.044	101	5.883	0.175	-5.2
HNTKNT	201	96	5.383	0.179	210	5.516	0.035	210	5.484	0.191	0.6
HNHKN	202	17	4.938	0.320	157	4.393	0.073	157	4.866	0.304	-9.7
HNTKG2	103	-	-	-	40	4.739	0.028	40	4.948	0.094	4.2
HNHKG2	204	19	3.900	0.417	97	4.289	0.083	97	3.759	0.363	14.1
HNTKSD	204	11	6.363	0.271	82	6.393	0.105	82	6.632	0.271	-3.6
HNHKG	206	74	1.370	0.755	265	1.530	0.400	265	1.562	0.764	-2.0
HSTKM	207	16	4.145	0.299	219	4.391	0.126	219	4.420	0.263	-0.7
HSTKW	208	4	4.796	0.101	30	4.767	0.056	30	4.856	0.100	-1.8

Table 14.14: Hearne Kriged & NN Estimate Comparison by Rock Group

Rock Group	Code	Composites			Kriged Estimates			NN Estimates			% Diff = (KRG-NN)/NN
		No.	Avg. cpm ³	CV	No.	Avg. cpm ³	CV	No.	Avg. cpm ³	CV	
TK_HG	200, 201, 205	154	5.596	0.197	393	5.630	0.071	393	5.725	0.210	-1.7
HK_MG	202, 204	36	4.371	0.386	254	4.349	0.079	254	4.399	0.348	-1.1
TK_MG	207, 208	20	4.277	0.271	249	4.405	0.125	249	4.435	0.259	-0.7
HK_LG	206	74	1.370	0.755	265	1.530	0.400	265	1.562	0.764	-2.0

Table 14.13 shows that the percentage difference between the kriged and NN block estimates are typically less than 5% for any given rock type. Rock types with percent differences around 10% are those belonging to the HK_MG group (HNHKN AND HNHKG2).

The difference in the composite means of these rock types is close to 1.000 cpm³; hence estimating using soft boundaries is the main reason for the percentage differences observed. Table 14.14 shows the comparison of statistics for the kriged and NN models by rock group. Percentage differences between the kriged and NN means are generally less than 4%, illustrating no bias exists in the estimate.

Initial estimation was completed without the capping of potential outliers. Validation results showed this not to be a problem for all units with the exception of HNHKG. Kriging estimation of HNHKG was

overestimating the composite mean by 10%. The locations of three higher grade outliers were identified on the unit's boundary with rock units with higher grades, and composites were capped to 3.0 cpm³. Both kriged and NN estimation were re-run with improved results.

14.2.4.8 BULK DENSITY MODEL

The 2003 Mineral Resource estimate applied an in-situ (wet) density rather than a standard dry density due to the limited number of dry density measurements available. In this update, dry density was used where available. Where too few dry measurements had been taken, available in-situ density measurements were converted to a dry density.

The average dry densities by lobe were calculated and applied to the mineral resource model using the values in Table 14.10.

14.2.5 GRADE ESTIMATION – TUZO

14.2.5.1 ESTIMATION APPROACH

As with 5034 North-East Lobe, the estimation of global grade using micro-diamonds was extended to allow the estimation of local block grades. This was achieved by combining models of stone density and diamond size distribution data and by estimating stone density locally. Calibration and consistency of the models was achieved using macro-diamond data collected from large diameter percussion drilling in 1999.

The close-spaced drill grid (35 m) in 2007 had the advantage of providing a high quality geological data set that included quantitative measures of dilution throughout the Tuzo body.

Estimation was carried out in three stages: estimation of global diamond content per litho-facies, estimation of block tonnage and finally local estimation of grade per mining block.

A key difference at Tuzo is the need for a dilution model on a local basis. Dilution was estimated in blocks so that a more accurate tonnage calculation can be made in the model. Consequently, grade estimates must be fully diluted. This is achieved by using the 2007 micro-diamond dataset.

14.2.5.2 ESTIMATION OF GLOBAL DIAMOND CONTENT PER LITHO-FACIES

Diamond size was the first component of diamond content to be modelled. Samples were combined and plotted on log-probability plots to observe the size distribution per litho-facies and to express the distribution of diamond size per litho-facies in terms of a statistical distribution. Diamond stone density or diamond concentration was the second component of diamond content to be modelled. Stone density was used to estimate diamond concentration by zone per litho-facies and locally in resource blocks. The statistical distribution of stone density was modelled per litho-facies and expressed in terms of a statistical distribution. The combination of stone density distribution and stone size distribution was used to reproduce (simulate) a representative diamond parcel statistically for comparison with observed samples.

14.2.5.3 ESTIMATION OF BLOCK TONNAGE

A detailed set of dilution measurements of drill core was prepared for every hole. The dilution measurements were used in a spatial analysis to obtain an estimate of the percent dilution in each resource block. Estimates for undiluted kimberlite density and granite density were combined with the percentage block dilution to calculate a block tonnage. Density estimates for kimberlite and granite were estimated locally. Block volume was split into kimberlite and granite volume based on the block dilution estimate and converted into tonnages by means of the kimberlite and granite density estimates. The two tonnage components were combined into a single block tonnage and used with block volume to derive an overall block density estimate.

14.2.5.4 LOCAL ESTIMATION OF GRADE

An estimate of stone density was made per mining block. These local estimates and block tonnages were used to calculate block stones, which were accumulated to total stones per litho-facies. The individual estimates of stones per mining block and the total stones per litho-facies were used with the global carats per litho-facies to calculate the carats in each mining block. The mining block carats were divided by the block tonnes (the total of kimberlite and granite tonnes) to give a grade in carats per 100 tonnes (dry).

The estimation procedure involved the following steps:

- diamond size distribution modelling
- diamond stone density distribution modelling
- estimation of the global diamond content per litho-facies. This is based on micro-diamond stone density distributions in combination with diamond size distribution models
- estimation of a local relative density for kimberlite and a global estimate of density for granite
- estimation of dilution per mining block
- estimation of local stone density using micro-diamond sampling
- proportioning of global diamond content into local blocks on the basis of local stone density.

These steps are explained in more detail.

14.2.5.5 SAMPLING DATA

A total of 367 samples of core were treated for micro-diamonds. The average sample weight was 8 kg comprising 2 m drill core sections and amounted to a total sample weight of 2,860 kg. The average dilution for the micro-diamond samples is 37%.

Table 14.15 shows a summary of micro-diamond recoveries broken down into the nine litho-facies units identified for the body.

Small numbers of samples were collected from units TK and EU with low likelihood of being used in advanced spatial analysis for diamond content.

Table 14.15: Tuzo Micro-diamond Recoveries

Rock Type	No. of Samples	Weight (kg)	Dilution (%)	Undiluted Wt (kg)	Stones (+md5)	Stones/8 kg (+md5) Diluted	Stones/8 kg (+md5) Undiluted
CR	9	65	23	50	205	25	33
EU	5	40	82	7	22	4	24
Granite	3	22	63	8	26	10	26
HK	28	215	28	155	911	34	47
TK	10	81	33	54	161	16	24
TKT2	169	1331	29	940	2832	23	33
TKTKT1H	21	155	30	109	452	23	33
TKTKT1L	16	129	36	83	221	14	21
TKTKT2	106	822	51	402	1085	11	22

Results from the 1999 and 2008 LDD programs were incorporated into this study and used in combination with micro-diamonds to model diamond size distributions to ensure the diamond size distribution is coherent over the entire diamond size range.

Table 14.16 shows a summary of LDD results broken down per litho-facies. No macro-diamond results were available for unit HK. Diamond recovery took place at a bottom cut-off of 1.5 mm; all stones are reported including those recovered below the bottom cut-off. Samples were not weighed, but sample volume was derived from hole-diameter and used in combination with density estimates to calculate an equivalent sample weight, as shown.

Table 14.16: Tuzo Results from GKJV LDD Sampling Carried Out in 1999 & 2008

	TK			TKT2			TKTKT1H			TKTKT1L			TKTKT2		
	2008	1999	Total	2008	1999	Total	2008	1999	Total	2008	1999	Total	2008	1999	Total
Cts/100t	108.55	68.33	91.09	119.04	114.78	117.63	244.48	276.21	247.77	872.74	99.38	143.55	54.91	59.27	57.67
Cts/100t +5	90.02	61.01	77.42	99.37	102.66	100.46	205.67	252.18	210.49	770.79	90.19	129.06	46.90	53.81	51.27
Volume m ³	23.81	18.34	42.15	74.04	36.30	110.34	233.12	25.26	258.39	3.99	34.47	38.46	56.68	100.13	156.81
Tons	58.68	45.03	103.70	180.65	89.40	270.05	538.05	62.20	600.25	5.10	84.20	89.30	140.56	242.09	382.65
Carats	63.70	30.77	94.46	215.05	102.61	317.66	1315.43	171.82	1487.24	44.52	83.68	128.20	77.18	143.49	220.67
Carats +5	52.82	27.47	80.29	179.51	91.78	271.29	1106.59	156.87	1263.46	39.32	75.94	115.26	65.93	130.28	196.21
Stones	797	380	1,177	2,806	1,187	3,993	16,084	1,841	17,925	401	940	1,341	907	1,678	2,585
Stones +5	451	274	725	1,691	820	2,511	9,486	1,337	10,823	250	671	921	586	1,234	1,820
Stones															
+23	0	0	0	0	0	0	1	0	1	0	0	0	0	0	0
+21	0	0	0	1	0	1	0	0	0	0	0	0	0	0	0
+19	1	0	1	1	1	2	10	3	13	2	0	2	2	0	2
+17	1	0	1	2	1	3	15	2	17	3	0	3	0	0	0
+15	0	0	0	1	2	3	9	3	12	0	2	2	2	0	2
+13	4	1	5	10	7	17	70	13	83	5	7	12	6	7	13
+12	4	3	7	8	6	14	99	19	118	6	10	16	6	16	22
+11	20	9	29	50	30	80	325	44	369	8	21	29	20	39	59
+9	43	27	70	146	83	229	912	115	1,027	27	67	94	55	122	177
+7	71	36	107	255	107	362	1,380	187	1,567	37	88	125	89	172	261
+6	107	66	173	410	184	594	2,281	316	2,597	54	166	220	139	323	462
+5	200	132	332	807	399	1,206	4,384	635	5,019	108	310	418	267	555	822
+3	280	84	364	937	277	1,214	5,478	394	5,872	137	198	335	288	337	625

GAHCHO KUÉ PROJECT 2014 FEASIBILITY STUDY N.I. 43-101 TECHNICAL REPORT

	TK			TKT2			TKTKT1H			TKTKT1L			TKTKT2		
	2008	1999	Total	2008	1999	Total	2008	1999	Total	2008	1999	Total	2008	1999	Total
+ 2	56	11	67	121	47	168	758	61	819	10	33	43	24	53	77
+ 1	10	10	20	47	32	79	277	36	313	2	30	32	8	40	48
- 1	0	1	1	10	11	21	85	13	98	2	8	10	1	14	15
<i>Carats</i>															
+23	0.00	0.00	0.00	0.00	0.00	0.00	25.14	0.00	25.14	0.00	0.00	0.00	0.00	0.00	0.00
+21	0.00	0.00	0.00	4.47	0.00	4.47	0.00	0.00	0.00	0.00	0.00	0.00	0.00	0.00	0.00
+19	2.53	0.00	2.53	2.58	2.14	4.71	26.94	8.74	35.68	5.58	0.00	5.58	3.15	0.00	3.15
+17	1.08	0.00	1.08	3.18	1.83	5.00	22.42	3.27	25.69	3.13	0.00	3.13	0.00	0.00	0.00
+15	0.00	0.00	0.00	0.87	2.30	3.17	12.36	4.09	16.45	0.00	2.29	2.29	2.04	0.00	2.04
+13	3.57	0.61	4.17	6.89	5.94	12.83	57.05	9.95	67.00	4.65	6.22	10.86	3.80	5.83	9.62
+12	1.93	1.29	3.22	4.07	2.71	6.78	53.31	9.59	62.90	2.57	5.26	7.82	2.45	8.00	10.45
+11	6.65	2.99	9.63	18.50	10.56	29.05	116.00	15.12	131.11	2.57	7.22	9.79	6.99	12.88	19.87
+ 9	8.43	5.69	14.12	29.66	17.18	46.83	189.22	22.98	212.20	5.84	13.65	19.49	10.81	25.34	36.14
+ 7	8.80	4.22	13.02	31.88	13.37	45.25	176.00	22.78	198.77	4.47	11.01	15.48	10.59	21.13	31.72
+ 6	8.86	5.30	14.16	34.25	14.65	48.90	191.54	26.21	217.74	4.53	13.66	18.19	11.77	26.84	38.61
+ 5	10.97	7.39	18.36	43.17	21.12	64.29	236.64	34.16	270.80	6.00	16.65	22.65	14.33	30.27	44.60
+ 3	9.50	2.94	12.44	32.19	9.45	41.64	187.84	13.15	200.99	4.86	6.69	11.55	10.54	11.69	22.23
+ 2	1.18	0.24	1.42	2.59	0.96	3.55	16.40	1.26	17.66	0.29	0.63	0.91	0.59	0.97	1.55
+ 1	0.19	0.11	0.30	0.70	0.36	1.06	4.14	0.47	4.61	0.06	0.38	0.44	0.12	0.48	0.60
- 1	0.00	0.01	0.01	0.06	0.07	0.12	0.46	0.08	0.54	0.01	0.05	0.05	0.00	0.08	0.08

14.2.5.6 DIAMOND DISTRIBUTION MODELLING

A cumulative size distribution curve was plotted for each micro-diamond sample to check for outliers with high sample counts. None were found. Initially individual size distribution models were fitted using micro- and macro-diamonds to model a distinct size distribution for each litho-facies. Modelling was done by means of probability plots of micro-diamond and macro-diamond results for each unit. In some cases, the grade-size curve was used to assist in determining an acceptable size distribution model. After reviewing the resulting plots, it was decided that a single distribution could reasonably be fitted to all rock types.

Initial parameters were established by means of a graphical method, followed by an iterative process in which a representative diamond parcel was simulated and plotted with the samples. This procedure was performed with great care not to allow adverse influence of sparsely populated size classes at the top end of the diamond size range. As a check for consistency, recovery factors were added to the simulated parcel, and the resulting truncated distribution was compared with the macro-diamond results. As an additional check, the simulated parcel was plotted with micro-diamond and macro-diamond results on a grade-size plot. These comparisons were reasonable.

14.2.5.7 DIAMOND DENSITY DISTRIBUTION MODELLING

Sampled stone densities were modelled to obtain a statistical distribution of stone density for each litho-facies unit. Stone density statistics derived from micro-diamonds are summarised in Table 14.17, which shows that stone density (+md5) for unit HK is highest at 34 stones/8 kg, followed by TKT2 at 23, TKTKT1H at 23, TK at 16, TKTKT1L at 14 and TK TKT2 at 11.

Histograms of stone density (diamond concentration in stones/kg) were used to create stone density models for each litho-facies where sufficient sampling was available. Due to the small number of samples, no models were created for units EU and TK.

Table 14.17: Results from GKJV Micro-Diamond Sampling

Rock Type	CR	EU	Granite	HK	TK	TKT2	TKTKT1H	TKTKT1L	TKTKT2
Number of samples	9	5	3	28	10	169	21	16	106
Sample weight (kg)	64.6	40.5	21.5	214.7	80.6	1331.5	155.0	129.4	822.0
Diluted %	23	82	63	28	33	29	30	36	51
Undiluted weight	49.7	7.4	7.9	155.1	54.3	940.2	109.0	83.3	401.9
Stones above md5	205	22	26	911	161	3832	452	221	1085
Stones / 8 kg diluted	25.4	4.3	9.7	33.9	16.0	23.0	23.3	13.7	10.6

14.2.5.8 ESTIMATION OF GLOBAL DIAMOND CONTENT PER LITHO-FACIES

The stone density models and diamond size distribution models were used to generate a diamond parcel for each litho-facies. A typical diamond parcel was generated for each litho-facies by simulating two million samples, with stone density and stone size appropriately drawn from the fitted.

14.2.5.9 SPATIAL ESTIMATION OF STONE DENSITY & PROPORTIONING OF THE GLOBAL DIAMOND CONTENT

Local diamond content was estimated based on the spatial distribution of stone density, using kriging.

Kriged estimates for stone density were used to split diamond content into resource blocks to form local diamond content estimates.

Stone density was analysed to determine spatial structure for diluted stone density. The local estimation procedure comprised kriging of stone densities, which were expressed as stones per 8 kg of sample, and used in a geostatistical analysis to examine its spatial structure in the body.

Validation of the kriged estimates was acceptable on a global basis, with no overall bias introduced.

The kriged block estimates were used to localize diamond content per litho-facies into resource blocks in terms of carats/100 t for recovery of stones greater than 1.5 mm (+5 ds).

The estimated zonal carat total was proportioned into the resource blocks in the zone on the basis of individual block stones (+md5). The proportion of block stones (+md5) to the total stones (+md5) for the litho-facies was applied to the total carats for the litho-facies to derive block carats at a nominal 1.5 mm or 1.0 mm bottom cut-off expressed as grade in carats/100 t.

Table 14.18 is a summary of block diamond content estimates showing a comparison of +5 ds diamond content estimates and +5 ds LDD sampling results. There are two comparison estimates using macro-diamonds. One is the overall average (middle columns) and the other is the declustered estimate from macro-diamonds (NN) in the right-hand columns. All results show reasonable comparison between estimated grade and LDD sampling grades for all the units, except in the case of unit HK, where no macro-diamond grade was available.

Table 14.18: Tuzo Zonal Grade Comparison

Unit	Factorised Zonal Grade Estimate at a Strict 5ds cut-off	Macro Sampling at strict 5ds				Declustered Macro Sampling		
		1999 cpht	2008 cpht	All cpht	Rel Diff (%)	NN (in Indicated Blocks)		
TK	63	61	86	74	3%	58	9%	
HK	158		152	152	4%	161	-2%	
TKT2	108	104	99	100	8%	101	7%	
TKTKT1H	208	254	209	213	-2%	195	7%	
TKTKT1L	98	91	371	123	8%	98	0%	
TKTKT2	48	49	46	48	0%	53	-9%	

14.2.5.10 DILUTION ESTIMATES AT TUZO

Granite dilution is significant at Tuzo. To understand the distribution of granite locally, a 3D model of crustal (granite) dilution was made using the 2007 core drilling (27 holes on a 35 m grid) and the most recent geological model update. Ordinary kriging was employed for estimation.

The major geological units were retained for analysis and estimation. Where insufficient numbers of samples were available to conduct confident statistical analysis, a zonal average was assigned. All fragmental kimberlite units were also combined as one and compared to the various individual units to determine the individual effect that each unit has on the estimates. The analysis focused on the upper part of the mineral resource (i.e., 408.92 to 60.92 masl). The granite raft at depth was excluded from the dilution data set. Ordinary kriged estimates validated well against sample data. An example validation plot is shown in Figure 14-24 and shows clear distinctions in granite content between the various units.

Figure 14-24: Granite Dilution Comparison – Bench Averaged Kriged vs. Bench Averaged Lithology

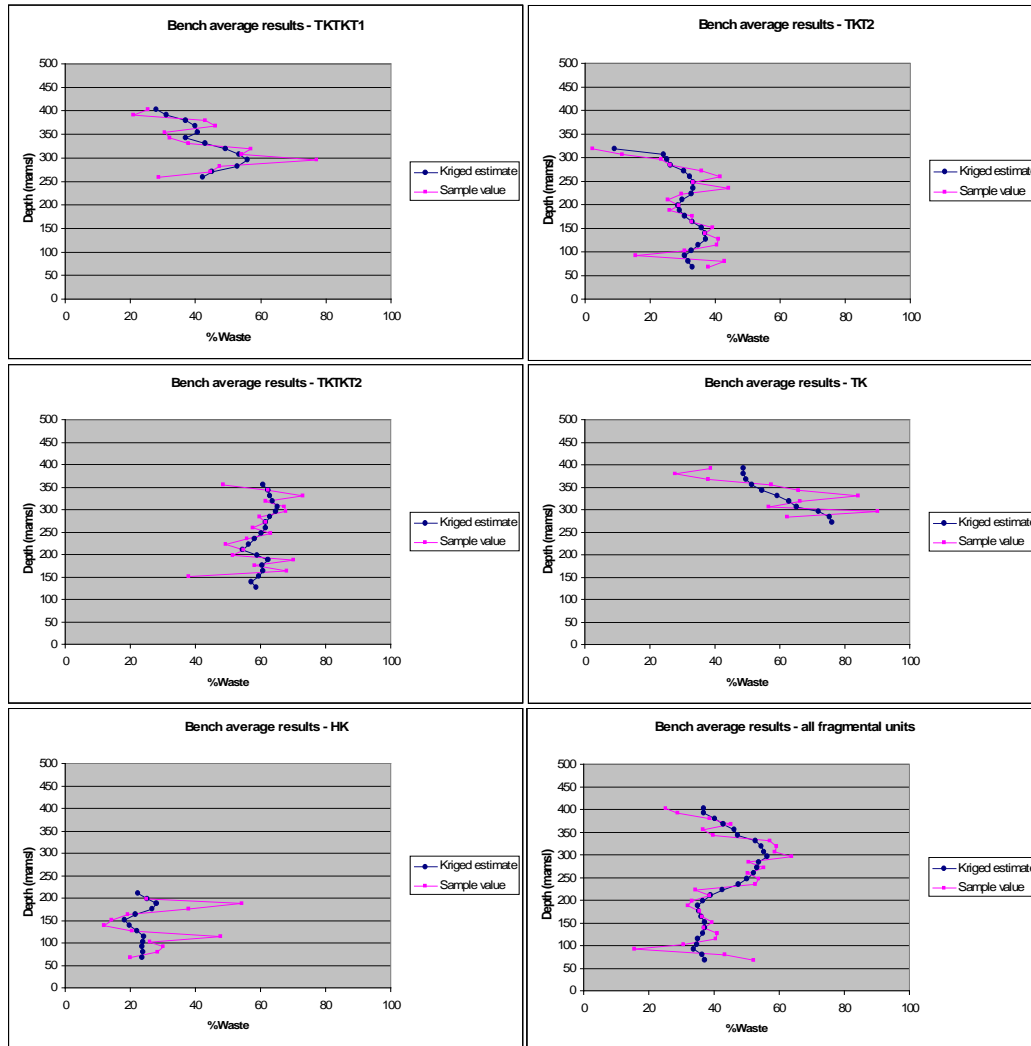

14.2.5.11 BULK DENSITY MODEL

Bulk density measurements (n = 679) from the 2007 core drill holes were used to estimate the bulk density of kimberlite and granite in each of the modelled kimberlite units. Local (block) estimates of kimberlite bulk density were obtained by interpolation of the kimberlite sample bulk density values (n = 313) using ordinary kriging. A single average bulk density value (2.65 t/m³) was assumed for all internal granite based on sample values (n = 366). Estimates of block tonnage were derived based on the local kimberlite and granite bulk density values combined with the estimated percentage dilution (mostly granite) for each block. Local estimates of the average diluted bulk density of each block were then obtained by dividing the block tonnage by volume.

Kimberlite sample bulk densities were corrected to a “dilution-free” basis using a combination of detailed line scan data for bulk density samples measured during the 2011/2012 Tuzo Deep campaign, and data for kimberlite samples with low dilution estimates. For modelling within the models classified as Tuzo Deep the average diluted bulk densities for each of the modelled geological domains in TZDI were estimated based on the average dry bulk density of all 2011/2012 kimberlite samples derived from each domain. Where sample bulk densities were determined by multiple methods

Table 14.19 summarizes average density resulting from the kriging process in the litho-facies units as defined in the block model and gives comparisons with sample data.

Table 14.19: Tuzo Sampled & Kriged Kimberlite Dry Density per Lithofacies

Kimberlite Bulk Density (t/m ³)				
Domain	No. of Samples	Average Sampled Kimberlite BD ¹	Average Block Kimberlite BD ¹	Average Block Diluted Kimberlite BD ²
HK	34	2.30	2.31	2.37
TK	27	2.20	2.21	2.44
TKT2	189	2.25	2.24	2.36
TKTKT1L / TKTKT1H	51	2.21	2.22	2.38
TKTKT2	130	2.23	2.23	2.48

14.2.5.12 TUZO DEEP ZONAL GRADE MODEL

Grade estimates for Tuzo Deep were generated on a zonal basis (i.e., average grade per domain) at a strict 1.0 mm bottom cut-off using combined microdiamond and macrodiamond datasets determined to be relevant to each domain. These were used in conjunction with an assumed constant size distribution curve for the Tuzo kimberlite to model average diamond grades per domain (Mineral Services 2013).

The zonal grade estimates for TZDI were made on the basis of the 2007 and 2011/2012 microdiamond data grouped by rock type (i.e., domain) and combined with macrodiamond data for equivalent rock types in Tuzo Upper, as obtained from the 2008 LDD sampling. Due to documented extensive diamond

breakage in the 1999 LDD samples (Seargent, 1999), these were not used in the grade estimation process for TZDI. Microdiamond and macrodiamond samples from domains in Tuzo Upper and TZDu were assigned to equivalent units for TZDI on the following basis:

- TKT2; TKTKT1H; TKTKT1L; TKTKT2 – assigned to the TKt domain
- HK – assigned to HK
- EU and CR (intersections of kimberlite in wall-rock) – assigned to CRXBX.

The combined microdiamond dataset used for modelling grades in TZDI is summarised in Table 14.20 and the 2008 LDD sample data, assigned to equivalent units of the revised TZD model are summarised in Table 14.21.

Table 14.20: Summary of Microdiamond Data Used to Model Average Domain Grades in Tuzo Deep

Rock Type	2011/2012 TZD MiDA				2007 MiDA (0-300 mbs) re-coded to 2012 domains					
	CRXBX	HK	TKt	TZD Total	CRXBX	Granite	HK	TK	TKt	2007 Total
Samples	22	26	35	83	14	3	29	10	311	367
Sample Mass (kg)	177	209	281	666	105	22	223	81	2,430	2,860
Diluted Mass (kg)	177	241	303	720	64		196		2,308	2,568
Stones / kg	1.38	8.63	6.15	5.67	4.25	2.00	7.59	3.12	4.08	4.32
-75 µm st	30	290	281	601	56	3	211	15	1,119	1,404
+75 µm st	55	440	397	892	119	10	375	55	2,229	2,788
+105 µm st	41	336	334	711	85	7	353	46	2,024	2,515
+150 µm st	38	263	236	537	69	8	251	36	1,551	1,915
+212 µm st	43	205	164	412	39	7	202	32	1,092	1,372
+300 µm st	27	131	127	285	35	4	146	26	931	1,142
+425 µm st	8	79	83	170	23	4	72	22	460	581
+600 µm st	1	38	50	89	14	0	44	15	275	348
+850 µm st	1	16	39	56	3	0	20	3	141	167
+1180 µm st	0	6	10	16	2	0	11	1	60	74
+1700 µm st	0	1	4	5	1	0	5	0	24	30
+2360 µm st	0	2	0	2	0	0	1	0	12	13
Total Stones	244	1,807	1,725	3,776	446	43	1,691	251	9,918	12,349
Total Carats	0.04	1.15	1.14	2.33	0.24	0.01	1.39	0.14	8.88	10.66

Table 14.21: 2008 LDD Data Grouped by Assigned Rock Type

Rock Type	TKT 2008	HK 2008	TK 2008
Mass (t)	845.85	9.53	42.98
Grade (cpht)	195	174	107
DTC23 st	1	0	0
DTC21 st	1	0	0
DTC19 st	15	0	1
DTC17 st	20	0	1
DTC15 st	12	0	0
DTC13 st	90	1	3
DTC12 st	118	0	4
DTC11 st	405	8	10
DTC9 st	1,139	12	31
DTC7 st	1,758	27	43
DTC6 st	2,882	27	79
DTC5 st	5,561	55	140
DTC3 st	6,840	55	219
DTC2 st	913	5	50
DTC1 st	334	0	10
DTC-1 st	98	0	0
Total Stones	20,187	190	591
DTC23 ct	25.14	0.00	0.00
DTC21 ct	4.47	0.00	0.00
DTC19 ct	38.24	0.00	2.53
DTC17 ct	28.72	0.00	1.08
DTC15 ct	15.26	0.00	0.00
DTC13 ct	71.69	1.11	2.46
DTC12 ct	62.24	0.00	1.93
DTC11 ct	144.63	2.96	3.12
DTC9 ct	235.30	2.19	6.24
DTC7 ct	222.54	3.18	5.55
DTC6 ct	241.94	2.12	6.60
DTC5 ct	299.88	2.90	7.77
DTC3 ct	235.42	2.03	7.28
DTC2 ct	19.85	0.12	1.05
DTC1 ct	5.02	0.00	0.19
DTC-1 ct	0.52	0.00	0.00
Total Carats	1,650.86	16.61	45.79

In order to be able to use diamond sampling data from Tuzo Upper (and TZDu) for modelling grade in Tuzo Deep, it was necessary to adjust the sample weights to account for:

- Differences in dilution between the 2011/2012 microdiamond samples from each domain in Tuzo Deep and the average for that domain as determined from continuous line scan

- Differences in overall percentage of dilution in the domains in Tuzo Deep and compared to those of the equivalent domains in Tuzo Upper / Tuzo (300-360mbs).

To adjust for the discrepancy between microdiamond and overall dilution in the Tuzo Deep (2011/2012) samples, for each domain, undiluted sample masses were first calculated based on the average dilution estimates for microdiamond samples representing the domain, and then were adjusted upwards based on the overall percentage of dilution in the domain, as determined from continuous line scan data. The same approach was applied to 2007 microdiamond samples from Tuzo Upper and Tuzo (300-360 mbs) domains. Undiluted sample mass estimated based on the microdiamond line scan data for 2007 samples and these were corrected using the percentage dilution estimates for the equivalent domain in TZDI. The 2008 LDD sample weights were corrected using the same procedure as that used for the 2007 microdiamond data, but in this case the sample dilution estimates were based on line scan data from pilot core holes (i.e., core holes drilled in effectively the same location as the 2008 LDD holes. The resultant corrected sample masses are represented in Table 14.22. Note that the averages are determined on the basis of rock types (domains) in the 2009 resource model of Tuzo Upper and TZDu to which the samples were allocated.

Table 14.22: Average Dilution Estimates for 2007 Microdiamond Samples as Generated from Sample Line Scan Measurements

Domain / Rock Type	MiDA Sample LS dilution %
EU	98
HK	24
TK	33
TKT2	30
TKTKT1H	34
TKTKT1L	36
TKTKT2	52

The combined microdiamond and macrodiamond data for each Tuzo Deep domain were plotted on grade-size curves and modelled using the fixed SFD defined for Tuzo (Table 14.23). The resultant total content diamond grade-size models were corrected to reflect commercial recovery at a 1.0 mm bottom cut-off using the 1.0 mm recovery factors defined for the Tuzo Upper resource estimate.

Table 14.23: Modelled Average Grades for Tuzo Deep Geological Domains

Domain	1.0 mm grade (cpht)
TKt_	155
HK	175
CRXBX-K	21

14.2.6 MODIFYING FACTORS FOR GRADE & DIAMOND SIZE DISTRIBUTIONS

14.2.6.1 INTRODUCTION

Modifying factors are typically applied to mineral resource grades to estimate the recovered grade of a main treatment plant (MTP). For conventional bulk sampling using macro-diamonds, these factors accommodate differences in liberation and lock-up between the product obtained from drilling (i.e., drill chips), and the final diamond recovery at the MTP.

Where the design of the MTP is known (e.g., during a feasibility study), process models may be used to indicate the degree of crushing and recovery efficiency of free diamonds that can be obtained for a given plant design. These process models can be used to estimate the factors used to adjust the diamond size distribution, average diamond value and resource grade. Where the final design of the MTP is unknown, then an assumption may be made that the MTP will crush and recover diamonds from the kimberlite at least as well as the LDD and bulk sample treatment processes.

Mineral resource grades based on micro-diamonds typically estimate a “total content” grade and diamond size distribution at a defined bottom cut-off. This grade and size distribution are only valid if a similar process to that used to liberate and recover the micro-diamonds is followed in the MTP (i.e., the kimberlite is dissolved and all stones recovered). Although such a process would maximize diamond recovery, a conventional MTP typically employs crushing, screening, dense medium separation and X-ray recovery and is not designed to release or recover all the stones in the kimberlite, but rather the majority of the intrinsic diamond value.

This means that the smaller (lower value) stones may not be fully released or recovered. To avoid presenting a misleading grade, the total content grade and size distribution is typically adjusted to allow for conventional production.

Herein the diamond size distributions were modelled to extraction and recovery processes of the bulk sampling and may differ from the characteristics of a specific MTP. As such further adjustments to the grade and average dollar per carat may be required when a final treatment process is finalised.

14.2.6.2 MODIFYING FACTORS FOR 5034 WEST LOBE, 5034 CENTRE LOBE & HEARNE PIPE

The grade of the 5034 West Lobe, 5034 Centre Lobe, and Hearne Pipe were estimated using macro-diamond data from bulk samples collected at a bottom cut-off of 1.5 mm. Analyses completed on the LDD results concluded that no adjustments were recommended to the grade estimates based on the LDD results from 5034 West Lobe, 5034 Centre Lobe and Hearne Pipe.

The corresponding diamond size distributions were estimated using micro-macro grade-size models where factors were applied to the total content diamond size distributions to reflect conventional MTP recovery (including incidentals) at a bottom cut-off of 1.5 mm.

Factors were also applied to bring the total diamond size distribution to a grade of 1.0 mm. As no sampling was carried out at this bottom cut-off, the difference in diamond content between the

1.5 mm bottom cut-off and the 1.0 mm bottom cut-off was expressed as a ratio. This ratio was then applied to the 1.5 mm grade estimates to arrive at a 1.0 mm grade for each mineral resource estimate.

The resulting diamond size distributions at the 1.0 mm bottom cut-off (including any incidental diamonds) are shown in Table 14.24.

Table 14.24: Final Diamond Size Distributions for 5034 West Lobe, 5034 Centre Lobe & Hearne Pipe

SIEVE CLASS	5034 Centre 1.0 mm	5034 West 1.0 mm	Hearne 1.0 mm
+23	0.605	0.786	0.586
+21	2.087	2.605	1.858
+19	3.585	4.263	3.012
+17	2.645	3.040	2.041
+15	1.720	1.943	1.423
+13	6.071	6.704	5.736
+12	5.059	5.437	4.237
+11	9.469	9.909	9.100
+9	13.039	13.203	13.608
+7	12.682	12.450	12.355
+6	12.973	12.405	12.405
+5	10.750	10.018	11.622
+3	13.401	12.079	12.972
+2	4.348	3.808	4.760
+1	1.566	1.351	4.283
-1	0.000	0.000	0.000

14.2.6.3 MODIFYING FACTORS FOR THE 5034 NORTH-EAST LOBE

For the 5034 North-East Lobe, a total content grade and diamond size distribution was estimated at a bottom cut-off of 1.0 mm (2 ds). These estimates assume that the recovery process will recover all the stones above the 2 ds. In reality, a conventional MTP employing crushing, screening, dense medium separation and X-ray recovery is not designed to release or recover all the stones in the kimberlite processed. For this reason, factors were applied to the total content grade and size distribution to allow for recovery in a conventional treatment plant.

A single diamond size distribution was estimated for the North-East Lobe. Table 14.25 shows the resulting diamond size distribution at a bottom cut-off of 1.0 mm.

The 1.5 mm factors were calculated by comparing the 1999 and 2001 LDD results from the East Lobe with the estimated total content size distribution for the combined North and East lobes. The two stone size distributions were compared on a grade-size plot where the LDD results were adjusted to match the total content size distribution. The ratio of the LDD stone grade to the total content stone grade was calculated for 5 ds and below. The ratio was set at 1.00 for 6 ds and above with the

assumption that all stones greater than 5 ds would be released and recovered. A similar process was followed for the 1.0 mm factors, except the total content stone distribution was compared to the 2007 LDD RC drill results. The core from this drilling was crushed and treated through a bulk sample plant with a nominal bottom cut-off of 1.0 mm.

Table 14.25: Final Diamond Size Distribution for 5034 North-East Lobe

Sieve Class	1.0 mm
+23	1.627
+21	2.058
+19	3.197
+17	2.098
+15	1.451
+13	5.568
+12	3.984
+11	8.363
+9	12.272
+7	11.080
+6	11.576
+5	16.261
+3	15.059
+2	4.343
+1	1.063
-1	0.000

14.2.6.4 MODIFYING FACTORS FOR TUZO PIPE

For Tuzo Pipe a total content grade and diamond size distribution was estimated at a bottom cut-off of 1.0 mm (2 ds). These estimates assume that the recovery process will recover all the stones above the 2 ds. In reality, a conventional treatment plant employing crushing, screening, dense medium separation and X-ray recovery is not designed to release or recover all the stones in the kimberlite processed. For this reason, factors were applied to the total content grade and size distribution to allow for recovery in a conventional treatment plant.

One size distribution was estimated for all of the units in Tuzo Pipe. The resulting diamond size distribution at the 1.0 mm bottom cut-off (including any incidental diamonds) is shown in Table 14.26. The 1.5 mm factors were calculated by comparing the 1999 and 2008 LDD results from Tuzo Pipe with the estimated total content size distributions for each rock unit. In each comparison, the two stone size distributions were compared on a grade-size plot where the LDD results were adjusted to match the total content size distribution. There were no bulk sample data for Tuzo at a bottom cut-off of 1.0 mm. For this reason, the 1.0 mm adjustment factors estimated for the North-East Lobe were used at Tuzo to create an adjusted grade and size distribution at a bottom cut-off of 1.0 mm.

Table 14.26: Final Diamond Size Distribution for Tuzo Pipe

Sieve Class	1.0 mm
+23	1.076
+21	1.571
+19	2.629
+17	1.805
+15	1.275
+13	5.039
+12	3.722
+11	8.038
+9	12.200
+7	11.320
+6	12.057
+5	17.239
+3	16.156
+2	4.673
+1	1.201
-1	0.000

14.3 Mineral Resource Classification

14.3.1 CLASSIFICATION PARAMETERS

In classifying the mineral resource, qualitative levels of confidence in the geological model and the estimates comprised of volume, grade, density, and average diamond value were assessed. The assessment also considered data integrity, methodology and adherence to procedures. The results of the classification are summarised in Table 14.27.

Table 14.27: Qualitative Levels of Confidence in the Mineral Resource Estimate

Kimberlite	Volume	Geology	Density	Grade	Revenue	Overall
5034						
West (above 121 masl)	Indicated	Inferred	Indicated	Indicated	Indicated	Indicated
Centre (above 121 masl)	Indicated	Inferred	Indicated	Indicated	Indicated	Indicated
North East (above 121 masl)	Indicated	Indicated	Indicated	Indicated	Indicated	Indicated
North Pipe	Inferred	Inferred	Inferred	Inferred	Inferred	Inferred
South Pipe	Inferred	Inferred	Inferred	Inferred	Inferred	Inferred
Hearne						
Above 217 masl	Indicated	Indicated	Indicated	Indicated	Indicated	Indicated
Below 217 masl	Inferred	Inferred	Inferred	Inferred	Inferred	Inferred
Tuzo						
Above 61 masl	Indicated	Indicated	Indicated	Indicated	Indicated	Indicated
Below 61 masl	Inferred	Inferred	Inferred	Inferred	Inferred	Inferred

14.3.2 RESOURCE CLASSIFICATION RISK FACTORS

The risk for 5034 is the small size and irregular “root zone” nature of the body that may impact volume estimates and edge dilution. For the 5034 West and Centre lobes, a “lobe” model was assumed in which internal geological units were not estimated separately: this may result in more variable grades than anticipated from the current model. For the North-East Lobe the geological models and resulting volumes are based on an internal geological model.

Simulation studies performed using LDD sampling show that the number of samples and their location in the West and Centre lobes is sufficient to define an Indicated mineral resource above 121 masl. No simulation studies were carried out for grade estimates in the North-East Lobe, but the amount of sampling given the shape and size of the North-East body is considered adequate for an Indicated mineral resource above 121 masl. The diamond parcel available for revenue estimation from 5034 is in excess of 3,000 ct and is adequate for average price calculations.

The North Pipe of 5034 is defined as an Inferred mineral resource. Limited sampling has resulted in a poorly defined volume and geological model. Micro-diamond data were used to estimate a zonal grade (overall average grade assigned to all blocks) for the pipe, and the diamond size frequency distribution for revenue purposes. No macro-diamond data are available for assortment analysis. For the purposes of estimating an average diamond value, the North Pipe was assigned the assortment data used for the North-East Lobe on the basis that the rocks in North Pipe are proximal to the North-East Lobe and are texturally and geochemically similar.

The South Pipe of 5034 is defined as an Inferred mineral resource. As with the North Pipe, there is limited sampling for this pipe resulting in a defined volume and geological model of lower confidence. Micro-diamond data were used to estimate a zonal grade for the pipe and a diamond size-frequency distribution. No macro-diamond data are available for assortment analysis. For the purposes of estimating an average diamond value, the South Pipe was assigned the assortment data used for the West Lobe. This is based on the proximity of the West Lobe to South Pipe. The South Pipe lies on the same structural trend as the West Lobe and is joined to West Lobe by a thin ribbon of brecciated kimberlite. Unlike the North Pipe, no whole rock chemistry was carried out to confirm geological similarity between the South Pipe and West Lobe. The West Lobe assortment is the lowest value assortment of 5034.

The volumes of the North and South Pipe are relatively small when compared to the rest of 5034 (2.5% and 3.6%, respectively, of the 5034 volume).

The risk in the Hearne Pipe is the internal geological model, which is complex. Simulation studies have shown that sample data for grade are sufficient to define an Indicated mineral resource above 217 masl. The number of samples falls off rapidly with depth. The macro-diamond parcel is in excess of 2,700 ct, and is sufficient for both size frequency distribution and assortment analysis.

Tuzo Pipe is geologically complex and carries significant amounts of dilution that is irregularly distributed throughout the body.

14.3.3 REASONABLE PROSPECTS OF ECONOMIC EXTRACTION

14.3.3.1 INTRODUCTION

The section is organised by presenting valuation discussions from the De Beers Group work and from the WWW International Diamond Consultants work; summarising the Whittle® runs and parameters; and a discussion of underground mining potential.

14.3.3.2 AVERAGE PRICE (AP) MODELLING – DE BEERS GROUP

Diamonds occur in very low concentrations, measured in parts per million for smaller-sized stones and parts per billion for larger stones (greater than 1 ct). Kimberlite samples vary in size depending on whether the intention is to assess the average grade, the diamond size distribution, or the average value of the pipe. The majority of diamond value is derived from the larger stones in the diamond size distribution. Even for large parcels of diamonds (10,000 ct or more) it is often difficult to obtain enough stones in the larger sieve classes to confidently estimate an average diamond value for that size class. As a result, it is usual in the diamond industry to model the diamond size distribution and/or the diamond value distribution⁶ to reduce the effects of sample size on the estimation process. In estimating the average diamond value for each kimberlite source, both diamond size and diamond value were modelled.

Diamond damage is not specifically addressed in the calculation of dollars per carat. However, the larger part of the parcel's values is derived from the 2000, 2001, and 2008 LDD sampling, in which diamond damage was much reduced relative to the 1999 campaign.

14.3.3.3 5034 LOBES, NORTH PIPE & SOUTH PIPE

Approximately 3,000 cts were valued from the Centre, West, and East lobes over three drilling campaigns in 1999, 2000, and 2001. A further 115 cts were recovered from LDC drilling carried out in 2007 at the northern end of the North-East Lobe. These data were not used for valuation purposes but were used to help validate the diamond size distribution estimated for the North-East Lobe. The two LDD programs of 2001 and 2002 constitute the majority of the diamond parcel available for revenue analysis.

For the West and Centre lobes, the combined micro-diamond and macro-diamond data were used to generate a diamond size distribution per source. This approach was used to accommodate different bottom cut-offs and different degrees of liberation in the macro-diamond bulk sampling. The same micro-macro models were used to estimate a single factor per source to move the 1.5 mm grade estimates to a 1 mm bottom cut-off (no bulk sampling was performed at the 1.0 mm bottom cut-off).

(6) Assessing the average diamond value per carat for a kimberlite requires knowledge of the diamond size distribution and the diamond value distribution. The diamond size distribution is a measure of the carat weight per size class. The diamond value distribution is the average value per carat in each sieve class and requires knowledge of the diamond assortment. The assortment distribution is more complex, requiring the carats in a given sieve size to be sorted and valued according to price. Diamond value is a combination of four parameters: size (ds), model (shape of stone), colour, and quality.

Grade estimates for the West and Centre lobes were made using bulk samples extracted from LDD. For the North-East Lobe a “total content” grade and diamond size distribution was estimated using micro-diamond samples at a bottom cut-off of 1.0 mm (2 ds). These estimates assume that the recovery process will recover all the stones above the 2 ds. In reality, a conventional MTP employing crushing, screening, dense medium separation and X-ray recovery is not designed to release or recover all the stones in the kimberlite processed. For this reason, adjustment factors were applied to the total content grade and size distribution to allow for recovery in a conventional treatment plant.

Comparison of the average diamond value per sieve class for the West, Centre, and East lobes showed that the Centre and East lobes had similar average diamond values per sieve class, while the West Lobe showed slightly lower average values in the -13 +6 sieve sizes. For this reason, two revenue distributions were prepared, one for the Centre and East lobes, and one for the West Lobe.

For the Centre and East Lobe diamond value model, the average diamond value per sieve class was adjusted for diamond sieve⁷ classes +6, +15, +17, +19, +21, and +23. The same size classes were adjusted in the West model. In making the adjustments, a composite revenue model was used as a guide. This model is based on data from kimberlite mines in the De Beers Group that have similar dollar per carat per sieve class values.

There are no macro bulk samples from the North Lobe, the North Pipe, and the South Pipe. For the North Lobe and North Pipe, the value model is assumed to be similar to the Centre and East lobes. For South Pipe, value is assumed to be similar to West Lobe. Considerable geological modelling was carried out for the East and North lobes that have demonstrated connectivity and continuity of geology between these two lobes. For this reason, the assumption of a similar assortment in the North Lobe to diamonds in the East Lobe is considered reasonable. Limited work was carried out on the North and South Pipes. The North Pipe lies 150 m north of the North Lobe. Whole-rock chemistry analysis of samples from the North Pipe suggests similar rocks to those in the North Lobe. For this reason, assuming a similar value model to the North-East Lobe is considered reasonable. The South Pipe lies approximately 200 m southwest of the West Lobe and lies on the same structural trend as the West Lobe. The South Pipe is joined to the West Lobe by a thin ribbon of kimberlite. No whole-rock chemistry was carried out to confirm geological similarity between the South Pipe and the West Lobe. Although the geological association with West Lobe is less certain than for North Pipe and North-East Lobe, the assignment of the West Lobe value model is considered reasonable for an Inferred mineral resource. The West Lobe model is the lowest value sizes model of the 5034 Lobes.

14.3.3.4 HEARNE PIPE

Grade estimates were made using macro diamond samples extracted using LDD. A total of just over 2,900 cts was recovered between 1998 and 2002 from the Hearne Pipe. Analysis of the diamond size distributions concluded that a single size distribution is adequate to represent all the geological units

(7) LDD diamonds recovered during drilling campaigns are discussed in terms of diamond sieve (ds) sizes. The sieve numbers are 23, 21, 19, 17, 15, 13, 12, 11, 9, 7, 5, 3, 2, and 1. Each sieve represents a punched metal plate with round holes of a set diameter. The lowest number represents the smallest opening and the largest number the widest opening. The diameter of the holes for diamond sieve 1 is approximately 1 mm and the diameter of the holes for diamond sieve 23 is approximately 10.3 mm. De Beers typically uses these sieves for sizing the production from its mines and for revenue analysis.

present in Hearne. This is supported by the grade-size plots generated from the micro- and macro-diamond data. The grade-size plots for the different units all tend to have the same profile, indicating a similar diamond size frequency distribution.

After examination of the diamond value data by rock type and by year, it was concluded that there was no reason to generate separate diamond revenue models per rock type. In modelling the value distribution for Hearne, the average diamond value per sieve class was adjusted for diamond sieve classes +5, +15, +17, +19, +21, and +23. As with pipe 5034, the adjustments were made using a composite revenue model as a guide.

14.3.3.5 TUZO PIPE

For Tuzo Pipe a “total content” grade and diamond size distribution was estimated using micro-diamond samples at a bottom cut-off of 1.0 mm (2 ds). These estimates assume that the recovery process will recover all the stones above the 2 ds. In reality, a conventional MTP plant employing crushing, screening, dense medium separation and X-ray recovery is not designed to release or recover all the stones in the kimberlite processed. For this reason, adjustment factors were applied to the total content grade and size distribution to allow for recovery in a conventional treatment plant.

For the Tuzo Pipe, approximately 600 cts were recovered in the 1998 and 1999 LDD campaigns, and a further 1,600 cts were recovered in 2008. The 2008 stones were recovered from two clusters of holes drilled in the near-surface high-grade portion of the pipe. These bulk samples were used to determine an average diamond value but were not used directly to determine grade.

The bulk of the carats for value modelling are taken from the high-grade zone of the pipe. Previous work based on the 1998 and 1999 parcel of 600 cts indicated that the assortment was not expected to differ within the fragmental rocks (these dominate the top 300 m of kimberlite). One hole was drilled to 300 m depth away from the clustered holes as a check on this assumption. Analysis of assortment data from this hole did not indicate any change in assortment.

A single assortment profile was modelled for the Tuzo diamond population. An adjustment was made to the average diamond value per sieve class for diamond sieve classes +15, +17, +19, +21, and +23. As with pipe 5034, the adjustments were made using a composite revenue model as a guide.

14.4 Mineral Resource Summary

The estimation and classification of the mineral resources was completed through the (AMEC 2009) and (Mineral Services, 2013) NI 43-101 reports. JDS has reviewed the reports and is of the opinion that the resource estimation and classifications adequately define the resource and are prepared to industry standards.

The resource inventory for the Gahcho Kué project encompassing inferred and indicated resources is 45 Mt and 75 Mct at a 1.0 mm bottom cut off.

Table 14.28: Mineral Resource Summary

Resource	Classification	Volume	Tonnes	Carats	Grade
		Mm3	Mt	Mct	cpht
5034 - (Amec 2009)	Indicated	5.1	12.7	23.9	188
	Inferred	0.3	0.8	1.2	150
Hearne - (Amec 2009)	Indicated	2.3	5.3	11.9	223
	Inferred	0.7	1.6	2.9	180
Tuzo Upper - (Amec 2009) (0-300 mbs)	Indicated	5.1	12.2	14.8	121
Tuzo - (Mineral Services 2013) (300-564 mbs)	Indicated	1.5	3.6	6.0	167
	Inferred	3.7	8.9	14.4	161
SUMMARY	Indicated	14.0	33.8	56.6	167
	Inferred	4.7	11.3	18.5	163

Notes:

- (1) Mineral Resources are reported at a bottom cut-off of 1.0 mm.
- (2) Mineral Resources are not mineral reserves and do not have demonstrated economic viability.
- (3) Volume, tonnes and carats are rounded to the nearest 100,000.
- (4) Tuzo volume and tonnes exclude 0.6 Mt of a granite raft and CRX_BX.
- (5) Resources have been reported in this report to remain consistent with previous technical reports.

SECTION 15 MINERAL RESERVE ESTIMATES

A Mineral Reserve is the economically mineable part of a Measured or Indicated Mineral Resource demonstrated by at least a Preliminary Feasibility Study. This Report includes adequate information on mining, processing, metallurgical, economic, and other relevant factors that demonstrate, at the time of reporting, that economic extraction is justified.

Mineral Reserves are those parts of the mineral resources which, after the application of all mining factors, result in an estimated tonnage and grade that is the basis of an economically viable project. The project must take account of all relevant processing, metallurgical, economic, marketing, legal, environmental, socio-economic and governmental factors. Mineral Reserves are inclusive of diluting material that will be mined in conjunction with the Mineral Reserves and delivered to the treatment plant or equivalent facility. The term 'Mineral Reserve' need not necessarily signify that extraction facilities are in place or operative or that all governmental approvals have been received. It does signify that there are reasonable expectations of such approvals.

Mineral Reserves are sub-divided in order of increasing confidence into Probable Mineral Reserves and Proven Mineral Reserves. A Probable Mineral Reserve has a lower level of confidence than a Proven Mineral Reserve.

The reserve classifications used in this Report conform to the CIM classification of NI 43-101 resource and reserve definitions and Companion Policy 43-101CP and are listed below:

A 'Proven Mineral Reserve' is the economically mineable part of a Measured Mineral Resource demonstrated by at least a Preliminary Feasibility Study. This Study must include adequate information on mining, processing, metallurgical, economic, and other relevant factors that demonstrate, at the time of reporting, that economic extraction is justified. Application of the Proven Mineral Reserve category implies the highest degree of confidence in the estimate with the consequent expectation in the minds of the readers of the report. The term should be restricted to that part of the deposit where production planning is taking place and for which any variation in the estimate would not significantly affect potential economic viability.

A 'Probable Mineral Reserve' is the economically mineable part of an Indicated Mineral Resource, and in some circumstances a Measured Mineral Resource, demonstrated by at least a Preliminary Feasibility Study. The study must include adequate information on mining, processing, metallurgical, economic, and other relevant factors that demonstrate, at the time of reporting, that economic extraction can be justified.

15.1 Use of Pit Shells to Evaluate the Mineral Reserve

JDS used Whittle® software to establish open-pit shells within which the mineral resources were declared. The Whittle® runs use a set of reasonable parameters to control their generation. The shells do not incorporate detailed engineering design, but use parameters that provide reasonable latitude for necessary refinements. Table 15.1 shows input parameters used to generate the pits.

Table 15.1: Whittle® Input Parameters

Parameter	Value
Total OPEX	C\$73.75/t processed
Mining Cost	C\$3.40/t mined
	C\$33.32/t processed
Processing Cost	C\$7.66/t processed
Power Plant	C\$6.24/t mined
Freight Cost	C\$5.64/t mined
G&A Cost	C\$14.61/t processed
Site Service & Sorting	C\$6.29/t processed
Selling Cost	4% of carat price for all pipes
Ore Losses Due to Mining	1%
Dilution	5034: 8.4%, Hearne: 7.8%, Tuzo: 2.8%
Exchange Rate	CAD 1.01:USD
Discount Rate	10%

The Whittle software varies the prices according to a factor (revenue factor) and generates a ‘breakeven’ pit shell for each revenue factor.

Pit shell selection was conducted on the basis that all three pipes will be mined for full ore exposure on each bench. No internal phases will take place. This mine method is most closely modelled within Whittle by way of the “worst case” discounted cash flow. Sensitivity to the escalation of real diamond prices relative to costs was conducted to analyze and guide the selection of the base case shells. An assumed 20% increase in prices was used over the life of the project. Shells were selected at the point where the incremental change in the worst-case discounted cash flow became increasingly negative. Figure 15-1 and Figure 15-2 illustrate the results of the base case optimizations for all three pits.

While Hearne was evaluated as a stand alone deposit, 5034 and Tuzo were evaluated as a pair due to their proximity and influence on one another. Several changes in the optimization parameters have taken place between the 2010 Feasibility Study (JDS 2010) and the Gahcho Kué 2014 Feasibility Study Report.

Figure 15-1: Hearne Whittle Results

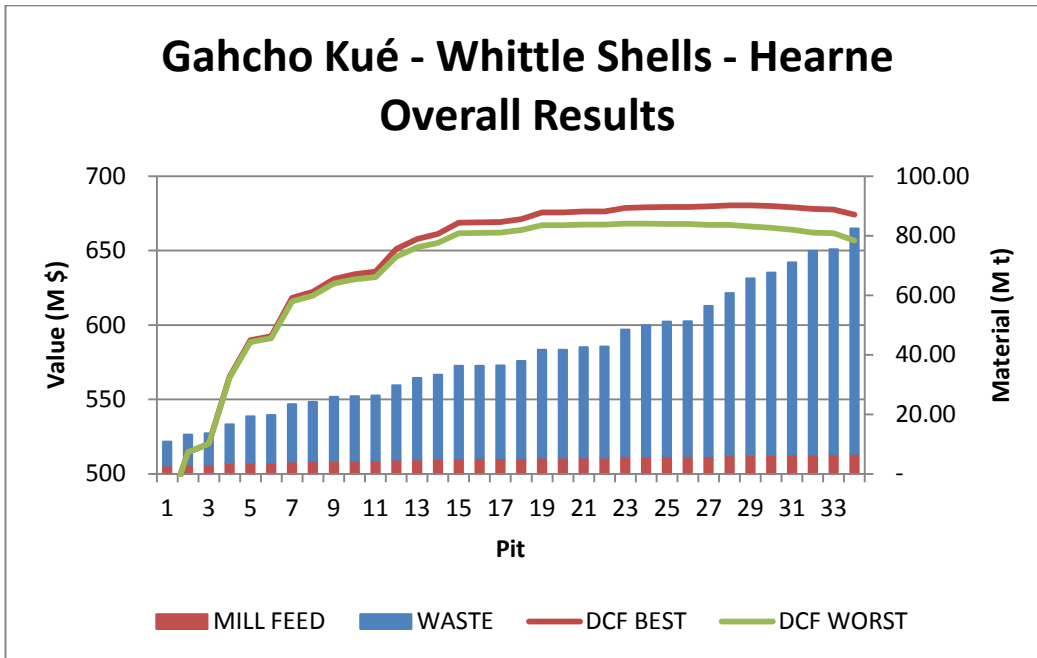

Figure 15-2: 5034/Tuzo Whittle Results

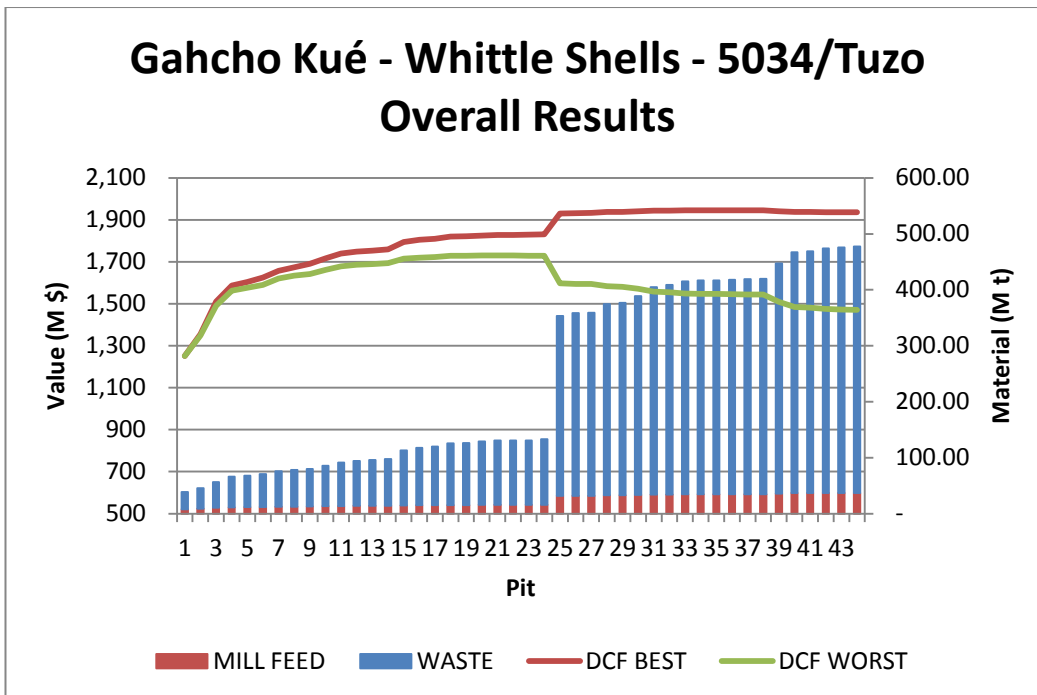
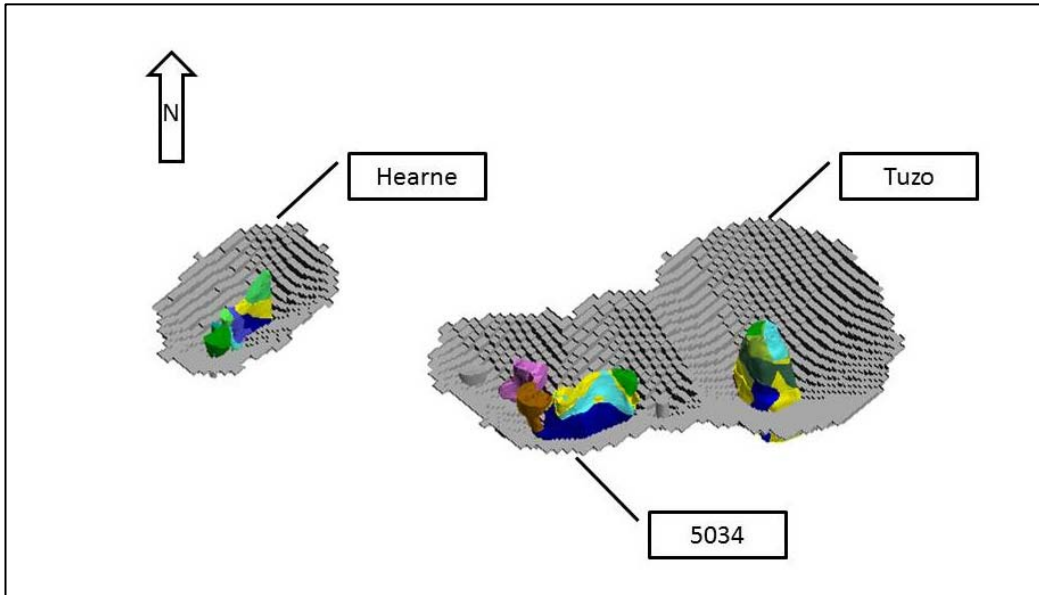

Figure 15-3: Perspective of Whittle Pit-Shell Used for Mineral Reserve Estimate



Mining in kimberlite is not usually selective, because there is typically no secondary evaluation of block grade (no blast hole sampling). On some operations, there can be selectivity at the scale of a geological unit (a basalt breccia for instance, or a low-grade zone of kimberlite). There are no such situations anticipated in 5034 or Hearne, but it is likely that the large granite raft in Tuzo could be separated as waste.

15.2 Open Pit Optimization

JDS completed Gemcom Whittle-Strategic Mine Planning™ (“Whittle”) pit optimizations and analyses on the Gahcho Kué resource model in order to provide guidance for the selection of appropriate preliminary economic and operational pit shapes. The objects of the Whittle pit optimizations were to maximize the extraction of the Indicated Resources outlined in the resource model. These pit shapes were then used as the basis to create detailed pit designs from which mineral reserves could be calculated.

The following parameters were used in the initial optimization (all economic factors were provided by JDS Mining):

- C\$73.75/t processed (total cost)
- C\$3.40/t mined
- C\$40.43/t processing and G&A
- Selling cost: 4% of process for all pipes
- Mining Losses: 1%
- Dilution:

- 5034: 8.4%
 - Hearne: 7.8%
 - Tuzo: 2.8%
- The diamond pricing (US\$/carat) as supplied by Mountain Province is based on the WWWW International Diamond Consultants 2012 valuation. These prices were escalated using 1.5% over US Consumer Price Index (CPI) plus 2.07% (escalation to the end of 2012) and plus 2.96% (escalation to end of 2013) for a total of 6.64% escalation on the prices provided to get the WWWW based 2014 figures. An average of the De Beers 1.0 mm Cut-off prices (as received from De Beers on January 30, 2014) and the escalated WWWW 2012 values were used to determine the diamond pricing and are reported below:
 - 5034 South: Price = US\$115.10/carat
 - 5034 West: Price = US\$118.77/carat
 - 5034 North: Price = US\$142.05/carat
 - 5034 Centre: Price = US\$136.30/carat
 - 5034 Northeast: Price = US\$145.72/carat
 - Hearne: Price = US\$100.60/carat
 - Tuzo: Price = US\$91.69/carat
 - Exchange Rate: 1.01 CAD:USD
 - Discount Rate: 10%
 - Other design factors as per the Mine Design Basis.

15.3 Dilution

Dilution was estimated by digitising an annulus around the geological Kimberlite resource material. The volumes of the geological solids are then compared against these expanded solids to estimate an average mining dilution percentage to apply to the individual pipes. The estimation of dilution was estimated with the updated geological interpretations and using the recommended methodology described above for a 1.0 m assumed annulus.

The results of the whittle shells selected as a basis for detailed pit design are shown in Table 15.2.

Table 15.2: Ultimate Pit Optimization Results

Whittle Results	Unit	5034/Tuzo	Hearne	Total
Whittle Shell Number		30	27	-
Revenue Factor		0.88	0.96	-
Process Life	years	11.2	2.0	13.2
Diluted Mill Feed Tonnage	Mt	33.6	6.1	39.7
Diluted Grade	cpt	1.47	2.04	1.56
Contained Carats	(Mcts)	49.5	12.4	61.9
Waste Tonnage	Mt	355.4	50.4	405.8
Strip Ratio	t:t	10.6	8.3	10.2
Total Tonnage	Mt	389.0	56.5	445.4

Whittle “worst case” discounted cash flow curves was used as the primary tool in pit shell selection. Additional optimizations were conducted based on the assumption that real diamond prices will escalate 1.5% over costs each year over the life of the project. At base case economic conditions, as diamond prices increase, any shell selected would be greater than the maximum of the worst case discounted cash flow and equal to or smaller than the revenue factor 1 shell. Shells were selected at the point where the incremental change in worst-case discounted cash flow became increasingly negative. Final shells were selected from the base case optimizations, taking into account the 20% real increase in prices over the life of the project.

Optimizations were conducted on Hearne as a stand-alone deposit; however, Tuzo and 5034 were optimised as a single package due to their proximity and influence on one another.

15.4 Open Pit Mineral Reserves

The pit shells summarised in Table 15.2 were used as a guide for detailed pit design. The results from the Ultimate Case Pit design, described in detail in Section 16, have been used as the basis for the reserve estimate. As the pit designs consider ramp widths and overall slope criteria, up to date costing information and detailed metallurgical assumptions, the reserves contained within these designs are considered probable and economic for extraction. Based on professional analysis, the shells selected present the most robust cash flow over the life of the project.

The mineral reserve estimate for each pipe is summarised in Table 15.3.

Table 15.3: Mineral Reserve Estimate (March 31, 2014)

Pipe	Classification	Tonnes (Mt)	Carats (Mct)	Grade (cpt)
5034	Probable	13.4	23.2	1.74
Hearne	Probable	5.6	11.7	2.07
Tuzo	Probable	16.4	20.6	1.25
Summary	Probable	35.4	55.5	1.57

The Mineral reserves identified in Table 15.3 comply with CIM definitions and standards for a NI 43-101 technical report. Detailed information on mining, processing, metallurgical, and other relevant factors are contained in the followings sections of this report and demonstrate, at the time of this report, that economic extraction is justified.

The economic viability of the project is presented in Section 22. Detailed mine planning, and the economic evaluation, have been performed on a sub-set of the Mineral Reserves in Table 15.3, which represent a 4.2% reduction in economic ore and a 27.2% reduction in waste. At the time of this report, JDS is of the opinion the project is economically viable using current diamond prices and prevailing long-term price estimates.

The feasibility study did not identify any mining, metallurgical, infrastructure or other relevant factors that may materially affect the estimates of the mineral reserves or potential production.

SECTION 16 MINING METHODS

16.1 Introduction

The mine design and planning for the Gahcho Kué 2014 Feasibility Study Report was based on the resource models as indicated in the previous sections.

16.2 Mine Planning & Design Criteria

Listed below are the general assumptions made with regard to mine planning:

- Plant start-up will begin in the Q3 2016 ramping up to full production at beginning of Q1 2017
- Pipes will generally be mined according to value with the 5034 and Hearne pipes to be concurrently mined followed by Tuzo
- Rock mined from the peninsula of 5034 will be used in the construction of dykes, roads, and other earthworks projects during the construction period
- Partial Kennady Lake dewatering will be completed in 2017, with subsections of the lake area completed early enough to allow full-scale waste stripping to expose mill feed in 5034 and Hearne and meet the production ramp-up schedule
- Mining sequence to balance available inventory of mill feed against minimal waste stacking.
- Both the 5034 and Hearne pits, once mined out, will be used to store waste rock and/or processed kimberlite tailings
- Conventional diesel-powered truck shovel mining methods
- The mine will purchase and operate all earthmoving equipment
- Outsourced maintenance by major suppliers.

16.3 Pit Optimization

JDS completed Whittle-Strategic Mine Planning™ (Whittle) pit optimizations and sensitivity analysis on the Gahcho Kué resource estimate and 3D block model to provide guidance for the selection of appropriate preliminary economic and operational pit shapes.

The objective of the Whittle pit optimizations was to maximize the extraction of the mineral resources outlined in the 3D resource block model. These pit shapes were then used as the basis to create detailed pit designs from which Mineral Reserves could be calculated.

The results of the pit optimization analysis are summarised in Table 16.1.

Table 16.1: Final Optimization Results Used for basis of Ultimate Pit Detailed Pit Design

Whittle Results	Unit	5034/Tuzo	Hearne	Total
Whittle Shell Number		30	27	-
Revenue Factor		0.88	0.96	-
Process Life	years	11.2	2.0	13.2
Diluted Mill Feed Tonnage	Mt	33.6	6.1	39.7
Diluted Grade	cpt	1.47	2.04	1.56
Contained Carats	(Mcts)	49.5	12.4	61.9
Waste Tonnage	Mt	355.4	50.4	405.8
Strip Ratio	t:t	10.6	8.3	10.2
Total Tonnage	Mt	389.0	56.5	445.4

The base case optimization was conducted on Hearne as a stand-alone deposit; however, 5034 and Tuzo were combined due to their proximity and influence on one another in determining ultimate pit shapes.

The optimal pit shells selected were based on the combined principles of incremental net present value (NPV) and cashflow, and included a review/analysis of best and worst case NPV, incremental costs, strip ratios and mill feed tonnages on a shell-by-shell basis.

Additional optimizations were conducted to better represent anticipated economic conditions and current price escalation assumptions. A 20% increase in diamond pricing was used to account for this expected escalation in diamond prices in real terms over costs. The results of these additional optimizations were incorporated in the final selection of the base case pit shells.

The mill feed tonnages and grades reported are based on the optimal pit shapes determined by the Design Criteria and economic parameters.

16.4 Pit Design

The final pit designs were developed by JDS using Maptek's Vulcan™ (Vulcan) mine design software. The final pit designs are the result of multiple iterations in which ramp locations and configurations have been examined in an effort to maximize recovery of the resource, minimize waste stripping, and provide for efficient haulage routes for the mobile equipment.

The Tuzo detailed pit design has been scaled back from the ultimate extents of the optimum Whittle shell, noted above, to reduce overall waste rock generated. The deficit between the recovered tonnages in the pit design and the tonnages contained in the original optimised Whittle shell represent a potential pushback opportunity for Tuzo, which should be examined in future studies.

Tonnage and grade quantities based on the Whittle shells versus the detailed pit designs are compared in Table 16.2.

Table 16.2: Comparison of Optimised Whittle Shells & Pit Designs

	Mill Feed (Mt)	Carats (Mct)	Grade (cpht)	Waste Tonnes (Mt)
<i>Selected Whittle Shells</i>				
5034/Tuzo	30.1	44.3	147	389
Hearne	6.1	12.4	204	50
Total	39.7	61.9	156	406
<i>Pit Designs</i>				
5034	13.8	23.2	168	116
Hearne	6.2	11.7	189	54
Tuzo	15.1	18.5	123	146
Total	35.1*	53.4	152	316

Note * Mineralised Tonnes include Reserve and an additional 1.2 Mt of dilution that will be processed through the mill.

The detailed pit designs for 5034, Hearne and Tuzo are illustrated in Figures 16-1 to 16-3.

Figure 16-1: 5034 Pit Design



Figure 16-2: Hearne Pit Design



Figure 16-3: Tuzo Pit design



In order to smooth waste stripping requirements, pushbacks were incorporated into both the 5034 and Tuzo pits.

16.5 Mine Production Plan

The detailed pit designs were used as the basis in developing the life-of-mine (LOM) production plans and schedules. The LOM plans were optimised to smooth waste stripping requirements, while ensuring adequate mineralised material exposure to meet mill feed requirements.

The LOM schedule includes Mineral Reserves, as well as an additional 1.2 Mt of dilution that will be processed through the mill. This added tonnage is at zero grade and does not provide any additional revenue, and is comprised of external waste at depth that is included in the pit design and is not classified as an Indicated Resource.

A number of constraints/targets were imposed on the LOM schedule and are summarised below:

- Pre-production/pit pioneering period from Q1 2014 to Q3 2016:
 - Maintain pre-strip tonnages within range of the 2010 Feasibility Study (under 20 Mt) to minimize pre-production capital requirements.
 - Mining rate to be ramped up through this period as equipment is delivered on the winter roads and by managing the shift and operating schedule.
- Mill start-up late Q3 2016. Mill ramp-up schedule as follows:
 - Target of 0.5 Mt of kimberlite to be mined in 2016.
 - Nameplate throughput achieved beginning of 2017 and LOM average 250 kt/month (3.0 Mt/a).
- Limit surface stockpile capacity to approximately 200 kt of mill feed.
- Maximum mining rate of approximately 39 Mt/a (total material for all pits).
- 5034 pit commences mining in 2014 – must be finished in timely fashion to allow backfilling of majority of waste from Tuzo pit.
- Hearne mining starts beginning of 2017 to allow for dyke construction and dewatering schedule.
- Hearne pit to be mined out within 4 years from plant start-up to allow for in-pit tailings deposition.
- Tuzo mining commences in 2020 to allow for dyke construction and dewatering schedule.
- Maintain reasonable annual bench advances in each pit.
- Maintain two working ore faces throughout schedule.

The 15-year mine production plan (including pit pioneering/pre-production) is summarised in Table 16.3 and shown graphically in Figures 16-4 and 16-5. The production plan shows annual diluted grades, mill feed tonnes, waste and overburden tonnages.

Table 16.3: Gahcho Kué Mine Production Plan

Year	Mill Feed	Ovb.	Granite	Total Waste	Total Mined	Strip Ratio	Mined Grade	Mined Carats
Units	Mt	Mt	Mt	Mt	Mt	w:o	cpht	Mct
2014	0.0	0.2	1.7	2.0	2.0	0.0	0	0.0
2015	0.0	0.4	1.9	2.4	2.4	0.0	0	0.0
2016	0.5	2.9	21.9	24.8	25.3	51.2	125	0.6
2017	3.0	2.5	33.7	36.2	39.2	12.1	176	5.3
2018	3.0	0.0	35.3	35.3	38.3	11.8	188	5.6
2019	3.0	0.0	28.0	28.0	31.0	9.5	199	5.9
2020	3.1	2.0	28.6	30.6	33.7	10.0	146	4.5
2021	3.0	0.0	30.4	30.4	33.4	10.1	185	5.5
2022	3.0	1.3	25.9	27.2	30.2	9.1	173	5.2
2023	3.0	0.0	31.7	31.7	34.7	10.6	159	4.8
2024	3.0	0.0	35.8	35.8	38.8	11.9	90	2.7
2025	3.0	0.0	19.3	19.3	22.3	6.4	90	2.7
2026	3.0	0.0	8.3	8.3	11.3	2.8	131	3.9
2027	3.0	0.0	4.0	4.0	7.0	1.3	147	4.4
2028	1.6	0.0	0.0	0.0	1.6	0.0	143	2.3
TOTAL	35.1	9.4	306.5	315.9	351.0	9.0	152	53.4

Figure 16-4: Annual Tonnes Mined & Grade

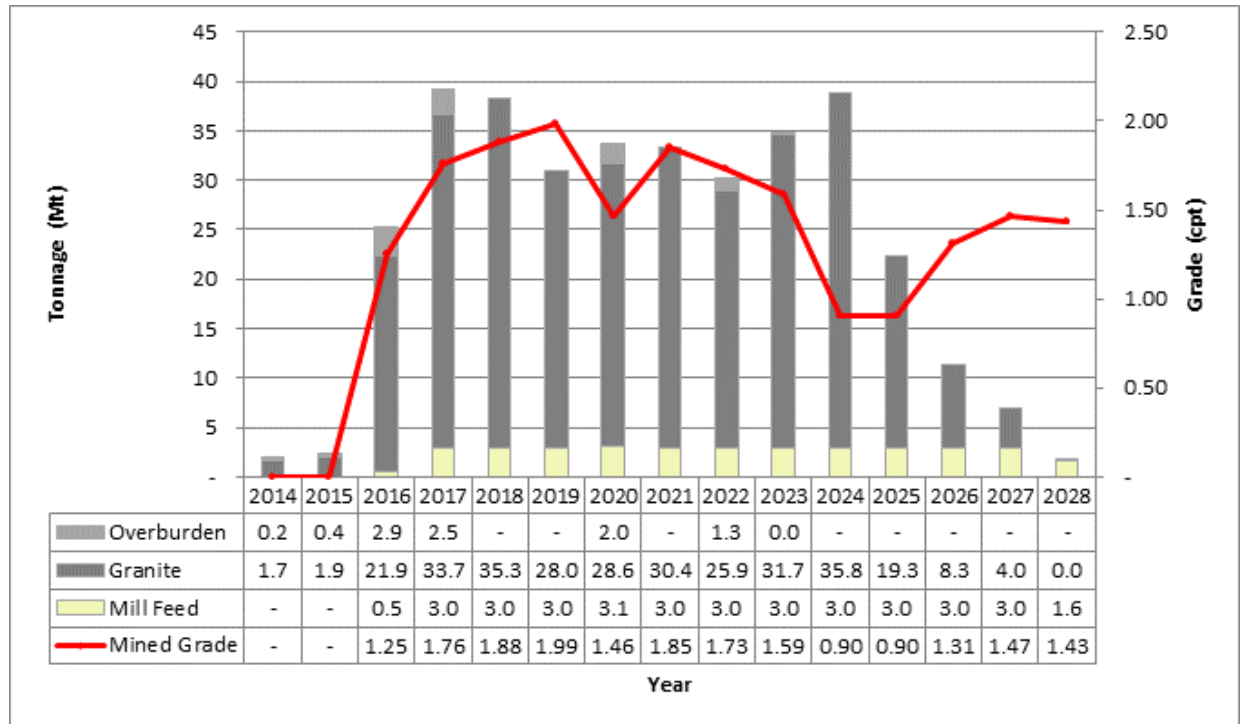
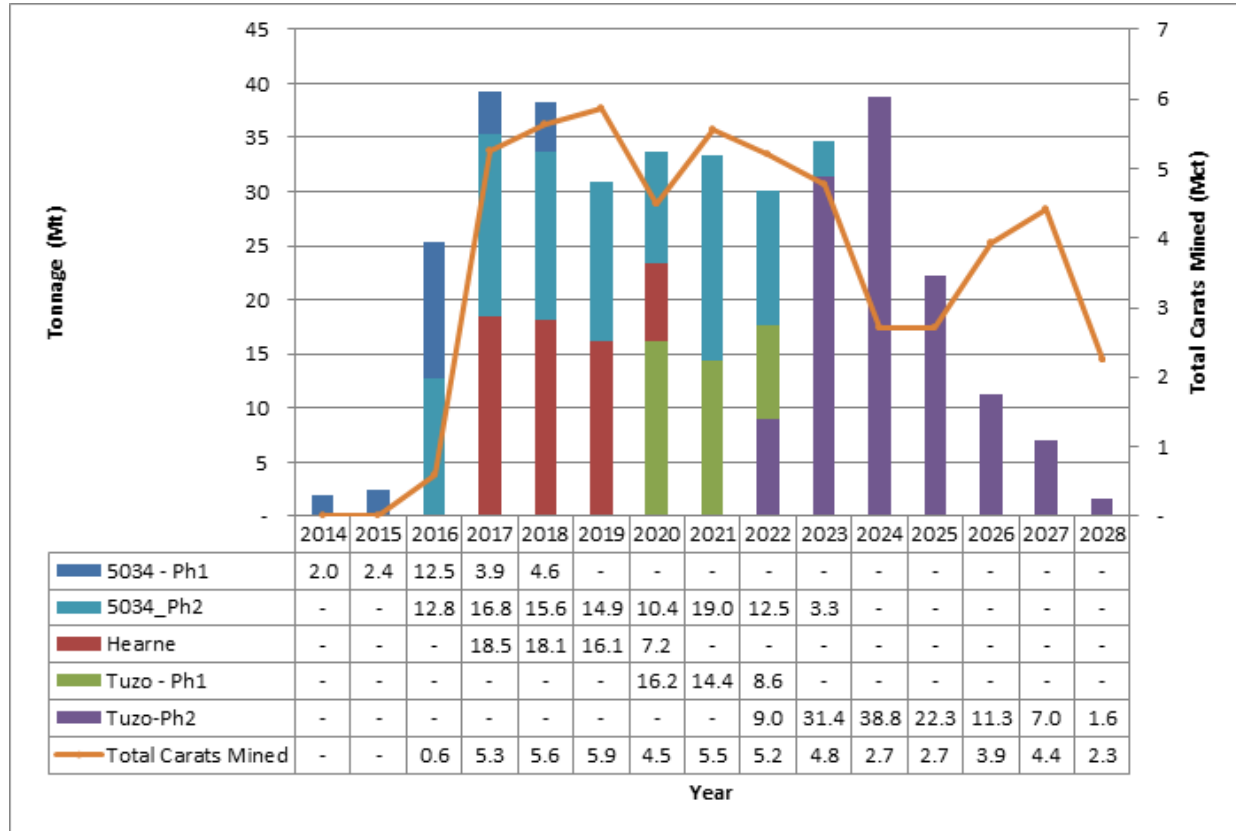

Figure 16-5: Tonnes Mined by Pit & Mined Carats



Pre-Stripping activity begins in Q1 – 2014 at the 5034 pit on the peninsula to the West of the plant site during the Pioneering Earthworks. Mining at 5034 is split into two phases. Phase 1 consists of partial bench exposure due to limited dry ground available prior to the dewatering of Area 6, and Phase 2 being full bench exposure. Granite waste and overburden excavated from pre-stripping will be used for dykes and site roads during the construction phase. Mining activity in 2014 through to 2016 is solely focused on 5034.

Plant ramp up at Gahcho Kué begins in late 2016, with the mining of 0.5 Mt of kimberlite with 0.4 Mt scheduled for mill feed and the balance to go to stockpile. Commercial production will be in 2017, with the achievement of 72 hours of continuous operation at or above nameplate to occur before the end of January 2017. Additional production milestones are summarised below.

- 2014 – Mining commences in 5034 Phase 1
- 2016 – Mining commences in 5034 Phase 2
- 2017 - Pre-stripping and production mining of Hearne prioritised as Area 6 dewatering is completed
- 2018 – 5034 Phase 1 mining completed

- 2020 - Phase 1 pre-stripping begins at Tuzo, Hearne pit completed
- 2022 – Tuzo Phase 1 mining completed and Tuzo Phase 2 begins with first mill feed from Tuzo achieved
- 2023 – 5034 Phase 2 completed
- 2028 – Tuzo Phase 2 pit is completed.

16.6 Mine Equipment

The mine equipment fleet has been subdivided into categories for cost estimation costing purposes:

- Load and Haul – shovels, large excavators, large loaders, haul trucks, dozer and graders
- Drill and Blast – production and pre-shear drills
- Site Services Support Equipment – small dozers and excavators, trucks, fuel/service trucks, tool carriers, pick-ups, buses, cranes and all other equipment.

16.6.1 EQUIPMENT SELECTION

Major mining equipment size and type has been selected based on the following criteria:

- Annual mine production schedule and waste stripping requirements
- Pit design parameters and working bench height
- Productivity and operating costs
- Proven original equipment manufacturers (OEM) with Canadian Arctic diamond experience
- Established supplier maintenance, repair and supply chain systems capable of supporting the owner's team
- Compliance with all safety and environmental standards.

The latest vehicle monitoring systems and in the case of dozers, graders and shovels, GPS collision avoidance systems have been included in final equipment specifications.

The mining fleet must deliver 3 Mt of kimberlite to the process plant during production and strip an average of 21 Mt of waste per year during the same period. Peak waste stripping is approximately 39 Mt per year in year 2020 as stripping begins at Hearne.

SMS-Komatsu is planned as the primary equipment supplier for the shovels, excavators, trucks and support equipment. Atlas Copco has been selected as the primary drill supplier.

Projected major equipment requirements are summarised in Table 16.4.

Table 16.4: Major Mining Equipment Fleet

Description	Unit	Total Fleet Size														
		2013	2014	2015	2016	2017	2018	2019	2020	2021	2022	2023	2024	2025	2026	2027
Excavators & Shovels																
29 m3 Front Shovel	PC5500	0	0	1	2	2	2	2	2	2	2	2	2	2	2	2
29 m3 Front Shovel - Spare Bucket	PC5500-BU	0	0	0	1	1	1	1	1	1	1	1	1	1	1	1
12 m3 Excavator	PC2000	0	1	1	1	1	1	1	1	1	1	1	1	1	1	1
2 m3 Track Excavator	PC390-1	1	1	1	1	1	1	1	1	1	1	1	1	1	1	1
2 m3 Track Excavator	PC390-2	0	1	1	1	1	1	1	1	1	1	1	1	1	1	1
Breaker attachment for 2m3 Track Excavator	PC390-RB	0	1	1	1	1	1	1	1	1	1	1	1	1	1	1
1 m3 Track Excavator	PC210	0	1	1	1	1	1	1	1	1	1	1	1	1	1	1
Haul Trucks																
240 ton Haul Truck	830E	0	0	8	8	9	11	11	11	11	11	11	11	11	11	11
100 ton Haul Truck	HD785	3	3	3	3	3	3	3	3	3	3	3	3	3	3	3
100 ton Water Tank	HD875-TK	0	0	0	1	1	1	1	1	1	1	1	1	1	1	1
40 t Articulated Haul Truck	HM400	2	2	2	2	2	2	2	2	2	2	2	2	2	2	2
Loaders & Tool Carriers																
17 m3 Wheel Loader	WA1200	0	0	1	1	1	1	1	1	1	1	1	1	1	1	1
12 m3 Wheel Loader	WA900-L	0	1	1	1	1	1	1	1	1	1	1	1	1	1	1
12 m3 Wheel Loader (Ore Feed)	WA900-S	0	0	1	1	1	1	1	1	1	1	1	1	1	1	1
4 m3 Wheel Loader	WA500	1	1	1	1	1	1	1	1	1	1	1	1	1	1	1
Tool Carrier	WA250	1	2	3	4	4	4	4	4	4	4	4	4	4	4	4
1 m3 Skid Steer Loader	246C	0	1	1	1	1	1	1	1	1	1	1	1	1	1	1
Bulldozers																
Track Dozer - Large	D375	0	1	3	4	4	4	4	4	4	4	4	4	4	4	4
Track Dozer - Small	D65EX	1	1	1	1	1	1	1	1	1	1	1	1	1	1	1
Rubber Tired Dozer	WD600	0	0	1	1	1	2	2	2	2	2	2	2	2	2	2
Motor Graders																
Motor Grader	16M	0	1	1	2	2	2	2	2	2	2	2	2	2	2	2
Drills																
250 mm Blasthole Drill	PV271	0	0	1	2	3	3	3	3	3	3	3	3	3	3	3
165 mm Blasthole Drill	D65	0	1	1	1	1	1	1	1	1	1	1	1	1	1	1
102 mm Airtrack Drill	DX800	1	1	1	1	1	1	1	1	1	1	1	1	1	1	1
Vibrating Packer	CS56	0	1	1	1	1	1	1	1	1	1	1	1	1	1	1
Forklifts & Cranes																
50 t Rough Terrain Crane	50t	1	1	1	1	1	1	1	1	1	1	1	1	1	1	1
135 t Rough Terrain Crane	130t	0	1	1	1	1	1	1	1	1	1	1	1	1	1	1
240 t Crawler Crane	240t	0	0	1	1	1	1	1	1	1	1	1	1	1	1	1
5 t Telehandler	GTH	0	1	1	1	1	1	1	1	1	1	1	1	1	1	1
Tractors, Flat Decks and Pickers																
Roll Off Truck	4900-RO	1	1	1	1	1	1	1	1	1	1	1	1	1	1	1
Winch Tractor	4900-WT	1	1	1	1	1	1	1	1	1	1	1	1	1	1	1
Scissor Neck Trailer		1	1	1	1	1	1	1	1	1	1	1	1	1	1	1
Dump Truck	4900-DT	0	0	1	1	1	1	1	1	1	1	1	1	1	1	1
Step Deck Trailer		0	1	1	1	1	1	1	1	1	1	1	1	1	1	1
Tridem Trailer		0	1	1	1	1	1	1	1	1	1	1	1	1	1	1
2 t Heated Van	F550-HV	0	1	1	1	1	1	1	1	1	1	1	1	1	1	1
20 t Flat Deck Truck w/ Rigid Boom Crane	4900-20t	0	1	1	1	1	1	1	1	1	1	1	1	1	1	1
10 t Flat Deck Truck w/ Folding Crane	4900-10t	0	1	2	3	3	3	3	3	3	3	3	3	3	3	3
Service Vehicles																
3/4 t Diesel Pick -Up (Blasters Box) Ford F250	F550-BB	1	2	2	2	2	2	2	2	2	2	2	2	2	2	2
Welding Service Truck Ford F550 (custom)	F550-WT	1	1	1	2	2	2	2	2	2	2	2	2	2	2	2
10 t Fuel Truck Western Star 4900 SA (custom)	4900-FT	0	1	1	2	2	2	2	2	2	2	2	2	2	2	2
Lube/Service Truck Western Star 6900 (custom)	6900-FL	0	1	1	2	2	2	2	2	2	2	2	2	2	2	2
3/4 t Ambulance/Rescue Ford F450	F550-AM	0	1	1	1	1	1	1	1	1	1	1	1	1	1	1
5 t Pumper/Ladder Fire Truck	KME-FT	0	1	1	1	1	1	1	1	1	1	1	1	1	1	1
Pickup Trucks, Vans & Busses																
3/4 t Diesel Crew Cab Pick -Up Ford F250	F350-CC	2	10	15	20	20	20	20	20	20	20	20	20	20	20	20
40 Passenger Bus Freightliner	FL-BUS	0	1	2	2	2	2	2	2	2	2	2	2	2	2	2

16.6.2 EQUIPMENT AVAILABILITY

The mine will operate 24 hours per day, 365 days per year. Shift employees will work 12-hour shifts on a 14-day cycle.

Equipment is expected to have an average mechanical availability of 86% over the life of mine. This average is based on declining availability as equipment ages, dropping from 90% to 85% respectively. The mine expected to be on standby/idle for 10 days of the year for uncontrollable delays due to adverse weather. Operating delays for all mine equipment include two hours per shift for shift change, breaks, refuelling, blasting. Loading equipment includes an additional 17% in miscellaneous delay time to account for such things as moves, face clean-up, etc. Trucks include an additional delay time of 1 minute per haul cycle to account for queuing at the loading unit and other miscellaneous delays. Thus, the effective operating hours per shift is approximately 8.3 hours or 500 minutes.

The maximum available hours for production for each unit is the product of the average mechanical availability (86%) and use of availability (97%) and operating efficiency (69%-loading / 80%-hauling) or $24 \times 365 \times 86\% \times 97\% = 5,065$ hours for loading equipment, varying slightly each year, and 5,800 hours for hauling equipment. Detailed equipment productivity calculations will be made on an annual basis for trucks, shovels and drills. Production support equipment will be factored on an annual basis according to material movement and/or assumed operating requirements.

16.6.3 MINE EQUIPMENT MAINTENANCE

The remote location of the mine, camp accommodation, air access, seasonal winter road and high cost of on-site manpower, necessitates considerable and substantial effort in maintenance efficiency. Equipment selection is purposely focused on minimising product variability, service and support technicians, and on-site maintenance and warehouse space, while maximising parts commonality and overall performance and reliability.

The selected OEM supplier (predominately SMS for Komatsu equipment) have proven integrated equipment and maintenance service capability to the existing major open pit arctic diamond mining operations. The maintenance philosophy consists of procuring the proven equipment fleet described previously, with a comprehensive planning, supply chain, warehouse and maintenance support package direct to the mine site.

The major equipment truckshop facility, designed with input from the OEM supplier (SMS), will be constructed and maintained by the owner. This facility will house the entire production, light vehicle, welding, tire shop and electrical instrumentation, warehouse, fuel and lube and wash bay. Complete with overhead cranes, offices, compressors, HVAC and major tooling, this building will support the integrated maintenance and supply chain team of owner and OEM supplier forces.

Major rebuilds will be scheduled to coincide with the winter ice roads to ensure exchanged parts can be transported on and off site during that period. Reduction of air transport and captive major parts inventory will remain the focus of the integrated maintenance team.

The shop warehouse will serve as an extension of the supplier's warehouse and internal inventory control to ensure necessary parts are adequately stocked, controlled and revised as necessary to achieve planned reliability rates. The integrated owner's and multiple suppliers' maintenance team will be structured as an alliance, whereby redundant personnel are eliminated and common services are provided by the best suited and shared personnel amongst the on-site group.

16.7 Explosives

Explosives will be supplied by a single service provider. Explosives consumption is based on material moved and powder factors. Explosives will consist of ammonium nitrate fuel oil (ANFO) and emulsion mixtures. All ammonium nitrate required for the year will be transported via the winter road and stored in tote bags. Mixing and delivering explosives to the hole will be the responsibility of the selected supplier, Orica Mining Services Canada (Orica). Gahcho Kué personnel will be responsible for the blasting pattern design and for tie-ins.

16.8 Mine Personnel

This section describes the methods used to estimate the mine operations, mine maintenance, site services and technical services personnel requirements.

Mine operations personnel are summarised in Table 16.5.

Mine maintenance personnel are shown in Table 16.6.

Table 16.5: WBS 1210 - Mine Operations Personnel

Description	Average Quantity 2014-2028	Max Quantity 2014 - 2028
<i>Mining Supervision</i>	10	12
<i>Drill & Blast</i>	17	23
<i>Explosives Contractor</i>	9	11
<i>Load & Haul</i>	66	85
Total - Mining & Earthworks	103	131

Table 16.6: WBS 1210 - Mine Maintenance Personnel

Description	Average Quantity 2014-2028	Max Quantity 2014 - 2028
<i>Mine Maintenance Supervision</i>	1	1
<i>Equipment Maintenance Contracto</i>	41	48
<i>Tire Service Contractor</i>	2	2
Mine Maintenance Total	44	51

Site services personnel are required to support mining operations, as well as provide site-wide services such as snow removal, freight handling, crane operation, aggregate crushing, and general site maintenance and electrical services. They include supervisors, labourers (skilled and unskilled), as well as equipment operators. Site services personnel are summarised in Table 16.7.

Technical services personnel are responsible for mine engineering, geology, surveying and IT/communication services. The number of personnel required is shown in Table 16.8.

Table 16.7: Site Services Personnel

Description	Average Quantity 2014-2028	Max Quantity 2014 - 2028
<i>Site Services Supervision</i>	2	2
<i>Site Services Personnel</i>	34	38
<i>Site Services Contractor</i>	-	8
Total - Site Services	36	48

Table 16.8: Technical Services Personnel

Description	Average Quantity 2014-2028	Max Quantity 2014 - 2028
<i>Supervision & Technical</i>	4	4
<i>Engineering</i>	9	10
<i>Geology</i>	6	7
Total - Technical Services	19	22

SECTION 17 RECOVERY METHODS

Hatch has developed the design basis for the processing plant and is of the opinion that the designs described below are adequate for the Report. ADP assisted in preparing the design criteria for the DMS and recovery sections. Hatch reviewed this work and is of the opinion that the design is adequate for the report.

17.1 Process Summary

De Beers Canada and Mountain Province plan on building a 3.0 Mt/a diamond mine in Northwest Territories of Canada. The mine will extract Kimberlite ore from three different kimberlite pipes: 5034, Hearne, and Tuzo.

In the process plant, this ore will be treated via crushing, screening, dense media separation and X-ray sorting, to produce a diamond rich concentrate that will be sent to Yellowknife for final cleaning and Northwest Territories Government valuation. The processing plant is targeting the recovery of liberated diamonds in the 1 to 28 mm size range. The processing plant is designed for efficient diamond recovery over the mine’s twelve-year life.

The following block flow diagram (Figure 17-1) shows the place of the Process Facilities (Area 3000) compared to the other key areas of the Gahcho Kué site.

Figure 17-1: High Level BFD of the Overall Process/Site

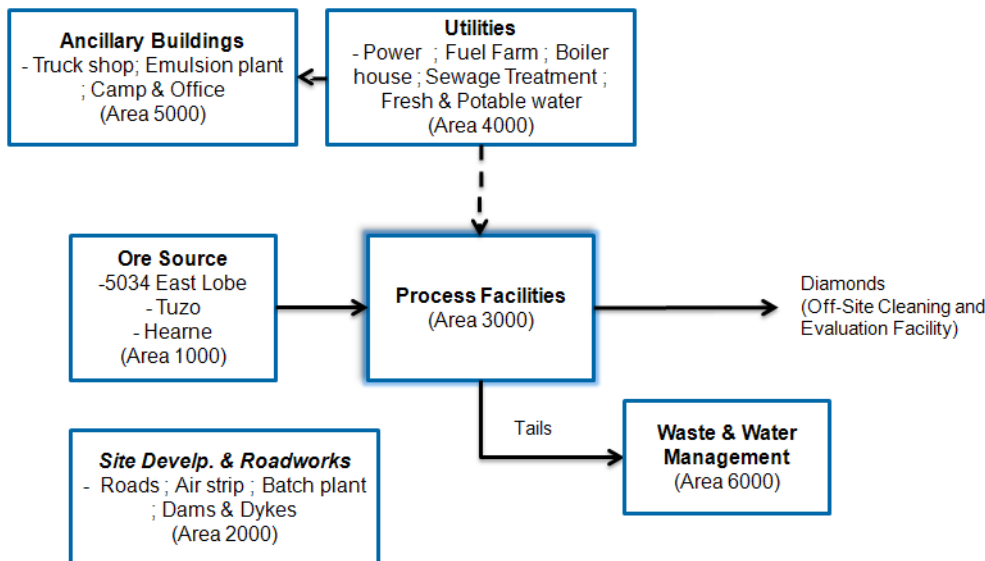

The process plant will employ 83 supervision, technical, operations and maintenance personnel.

The section below presents further details on the following aspect of the processing plant:

- Process plant high level block flow diagram and annual mass balance
- Process plant description & Process Design Criteria
- Design criteria
- Plant control philosophy
- Basis of design of the process plant building
- Dynamic simulation (confirming plant capacity)
- Plant personnel requirements.

17.2 Process Description

This section of the report gives a high-level overview of the various sectors for the diamond processing plant of the Gahcho Kué (GK) project.

The update for the processing was undertaken by Hatch with inputs from ADP (Recovery & DMS) and De Beers.

The development and selection of the flowsheet and some contributing trade-off studies are detailed below:

- Gahcho Kué Phase II Ore Dressing Study, 2240-900559-ODS-00006-5624, Phakamele Tomo, De Beers, rev. 1, 22 April 2005.
- Gahcho Kué Tuzo Slimes Dewatering Tests Report, 2240-R00219-PSS-00001-5624, Phakamele Tomo, De Beers, rev. 1, 19 May 2008.
- ODS Review - Comminution, GAH-R00402-721-001, Phakamele Tomo Debtech, 22 April 2005, rev. 1.
- High Pressure Grinding Test – Gahcho Kué Deposit, 2337 3444, Krupp Polysius Research Centre, Petra Lackmann / Rene Klymowsky, 6 July 2010.
- Hatch – Gahcho Kué Project Study Report, P. Lépine, Hatch, H333420-0000-00-124-0002, rev. 1, 22 July 2010.
- Hatch – FEED DCN#005 Independent Conveyor Route to DMS Plant, M. Bourrassa, Hatch, H333420-0000-00-124-0005, rev. 0, 22 February 2013.
- Hatch – FEED DCN#0012: Stress Test Report, M. Bourrassa, Hatch, H333420-0000-95-124-0012, rev. 0, 5 August 2013.

17.2.1 PROCESS PLANT DESCRIPTION – GENERAL OVERVIEW

Figure 17-2 presents the high-level block flow diagram of the process plant while Table 17.1 presents the high-level mass balance of the plant.

Figure 17-2: High Level BFD – Gahcho Kué Project

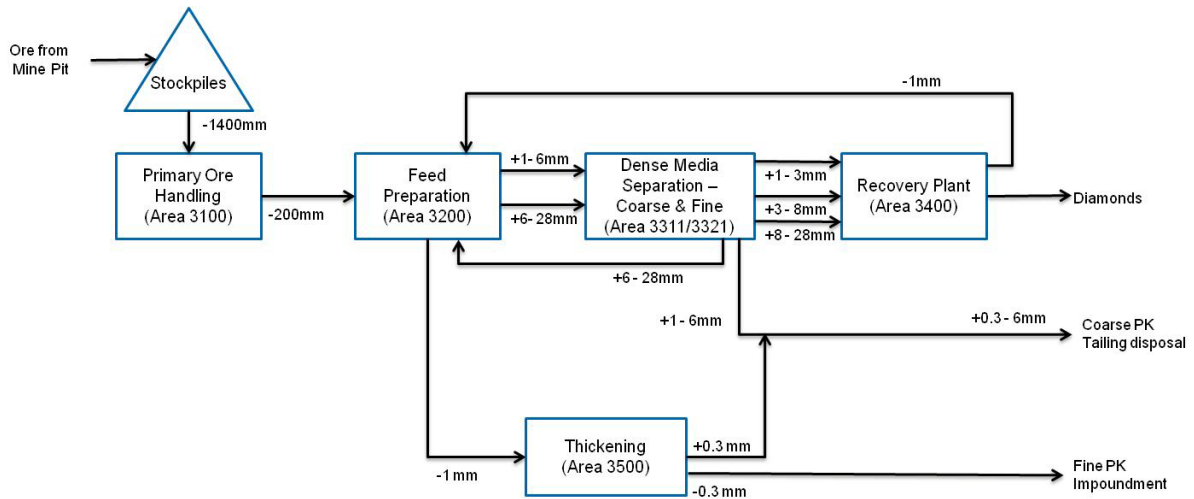

Table 17.1: High Level Mass Balance - Yearly

Description	Yearly Throughput (Mt/a)	Ave. Throughput (t/h)	Fraction
<i>Plant Feed</i>			
Ore to Main Treatment Plant	3.0	418	100
<i>Plant Tails</i>			
Coarse Process Kimberlite Tails			73
Fine Process Kimberlite Tails			27

The process facilities (Area 3000) are divided into the following areas and sub-areas:

- Primary Ore Handling (Area 3100)
 - Primary Crushing (Area 3110)
 - Exterior Conveyors and Coarse Ore Storage (Area 3120)
- Feed Preparation (Area 3200)
 - Primary Scrubbing and Screening (Area 3210)
 - Secondary Crushing (Area 3220)
 - High Pressure Grinding Rolls (Area 3225)

- Secondary Scrubbing and Screening (Area 3230)
- Dense Medium Separation (DMS)
 - Common Systems (Area 3300)
 - Coarse DMS Module (Area 3311)
 - Fine DMS Module (Area 3321)
- Recovery Plant (Area 3400)
 - Fine Magnetic Separation (Area 3400)
 - Primary & Secondary Wet X-Ray Circuit (Area 3400)
 - Drying & Re-Concentration X-Ray Circuit (Area 3400)
 - Grease Belt Scavenging Circuit (Area 3400)
 - Sorthouse: Glove Box Defalsifying, Single Particle Sorter (SPS), Weighing, and Packaging (Area 3440)
- Thickening (Area 3500)
 - Degrit Cyclones and Dewatering Screen (Area 3500)
 - Thickener & Flocculant (Area 3500)
 - Coarse PK Reject Conveyor & Disposal (Area 3321)
 - Fine PK Reject Pumping to the Fine PK Impoundment (Area 3500)
- Plant Water and Air Systems (Area 3600)
 - Process Facility Water System (Area 3610)
 - Reclaim Water (Clarified) (Area 3611)
 - Raw, Fire and Gland Seal Water (Area 3612)
 - Process and Instrument Air Distribution (Area 3620)

17.2.2 AREA 3100 – PRIMARY ORE HANDLING

The purpose of the primary ore handling area is to:

- crush run-of-mine ore (ROM) from -1400 mm to -200 mm for treatment in the process plant
- provide buffer capacity between the mining and plant operations
- allow for a continuous and steady feed to the process plant.

Figure 17-3 presents the high-level block flow diagram of the primary ore handling.

Figure 17-3: High Level BFD – Area 3100 – Primary Ore Handling

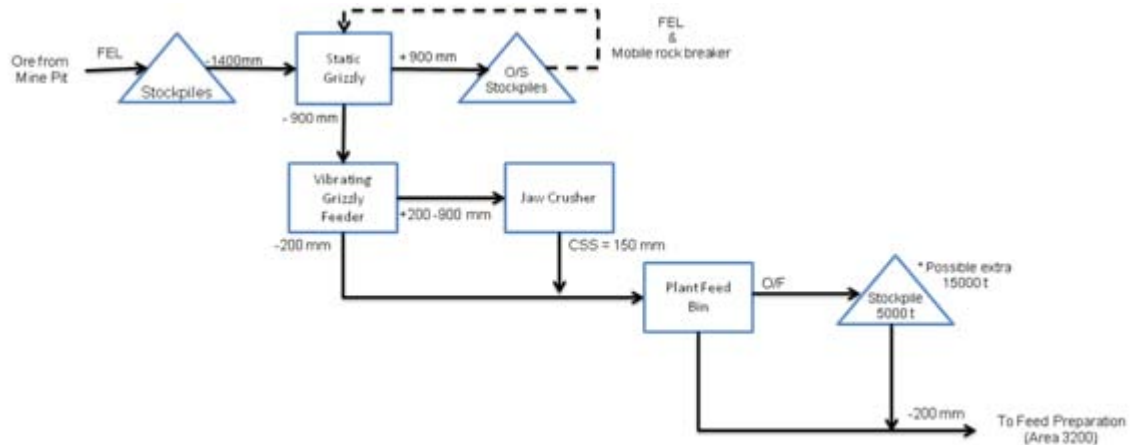

The ROM ore is fed by a front-end loader from the ROM stockpile to the 900 mm aperture static grizzly. The front-end loader will also pre-sort and remove oversize (+900 mm) material from the ROM stockpile and the static grizzly. Oversize material will be stored in the ROM oversize stockpile for secondary breakage by a mobile rock breaker before being fed back to the static grizzly.

The ROM plant feed hopper capacity is 50 tonnes of -900 mm ore, approximately two bucketloads. The vibrating grizzly feeder withdraws the ore from the ROM Plant Feed Hopper and simultaneously screens it at a cut size of 200 mm. The oversize +200 mm fraction is fed to the primary jaw crusher operating at a closed side setting of 150 mm.

The -200 mm feeder undersize and jaw crusher product are collected on a conveyor and directed towards a 100 t capacity plant feed bin.

In the event that the crusher production exceeds processing demand, the feed to the bin can be diverted to the coarse ore stockpile. This option also allows de-coupling of the primary crushing stage from the feed preparation area.

Ore is withdrawn from the plant feed bin by a variable speed belt feeder onto the plant feed conveyor. Ore from the coarse ore stockpile is recovered by a front-end loader through a 250 mm aperture static grizzly into the stockpile reclaim hopper and then withdrawn by a variable speed belt feeder onto the plant feed conveyor.

The coarse ore stockpile has a capacity of 5,000 tonnes. Space will be reserved to allow an additional 15,000 tonnes of coarse ore to be stockpiled.

All the primary ore handling equipment is located outside. Mobile crane will be available for maintenance of the equipment in these areas.

Throughput can vary depending on ore hardness. If the amount of granite inside the ore is higher than expected, the performance of crushing circuits will be affected (throughput will decrease and maintenance requirements will increase). Operations can try to blend ore from different pits to

minimize this problem should it occur. Primary crushing capacity may be affected by freezing up on conveyor systems or reduced capacity with soft ore. Should this occur, mitigation plans are foreseen including a temporary mobile crusher and using an external crushed ore stockpile.

17.2.3 AREA 3200 – FEED PREPARATION

17.2.3.1 GENERAL

The purpose of the feed preparation area is to prepare the ore for gravity separation and diamond recovery by:

- Crushing the -200 mm ore from area 3100 to -28 mm for treatment in dense media separation area 3311 & 3321 (the use of HPGR maximizes diamond liberation)
- Rejecting slimes and grits (-1mm) to avoid overloading of the downstream process
- Separating the crushed ore into two distinct streams: Coarse (-28 +6 mm) and Fine (-6 +1 mm).

Figure 17-4 presents the high-level block flow diagram of the feed preparation area. This area includes the sub-area of the following:

- Primary Scrubbing Screening (Area 3210)
- Secondary Crushing (Area 3220)
- High Pressure Grinding Roll (HPGR) (Area 3225)
- Secondary Scrubbing & Screening (3230).

Figure 17-4: High Level BFD – Area 3200 – Feed Preparation

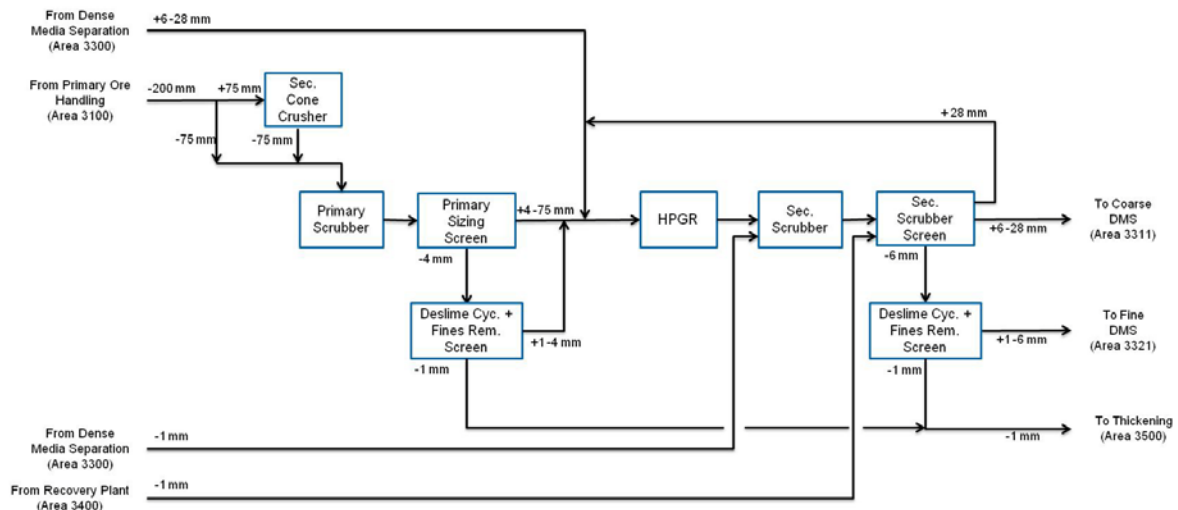

The plant feed conveyor discharges onto a vibrating grizzly feeder with a 75 mm cut size. The oversize is crushed in the secondary cone crusher operating at a closed size setting (CSS) between 35 and 38 mm. The undersize and -75 mm cone crusher product are sent to the primary scrubber and then

transferred to the primary sizing screen. The primary scrubber helps in liberating all particles prior to screening.

The primary sizing screen separates the plant feed into +28 mm, +4 mm, and -4 mm size fractions. the -4 mm undersize is pumped to the deslime cyclone and fines removal screen. The fines removal screen separates the feed into +1 and -1 mm size fractions. All the +1 mm screen oversize is collected by conveyors and fed to the 200 t capacity HPGR bin. Screen -1 mm undersize is pumped to the degrit cyclone pumpbox for disposal.

17.2.3.2 AREA 3225 – HIGH PRESSURE GRINDING ROLL

A variable speed belt feeder withdraws the -75 + 1 mm material from the 200 t HPGR bin to the HPGR. A metal detector is installed on the belt feeder to protect the HPGR from metal reaching the rolls and causing damage to the studs.

HPGR product discharges onto a conveyor and is transferred to the secondary scrubber.

A wet dust collection system treats the dust generated by the HPGR. The effluent reports to the secondary scrubber sizing screen.

17.2.3.3 AREA 3230 – SECONDARY SCRUBBING & SCREENING

The task of this equipment is to disagglomerate the compacted HPGR flake prior to screening and removal of the -1 mm fine material.

The scrubber discharges onto a double deck vibrating screen separating at 28 and 6 mm. The +28 mm material is recycled to the HPGR bin. The lower deck discharges the -28 + 6mm material to a conveyor from where it is transferred to the coarse DMS bin.

The -6 mm material is collected and pumped to the deslime cyclones. The deslime cyclone underflow discharges onto a single deck, multi-slope vibrating screens to remove the -1 mm material. The screened oversize material (-6 + 1 mm) discharges onto a conveyor from where it is transferred to the fine DMS bin.

Magnets are installed on the conveyor routes to remove any metallic material prior to the DMS modules.

17.2.4 AREA 3300 – DENSE MEDIUM SEPARATION

The purpose of the dense medium separation (DMS) is to:

- separate the heavy minerals of density greater than approximately 3.1 (sinks), including diamonds, from lower density rejects material
- reject light material (floats) that is liberated between -6 to 1 mm for Processed Kimberlite (PK) disposal.

Figure 17-5 and Figure 17-6 present the high-level block flow diagram of the DMS areas. The areas consist of two similar treatment lines for:

Figure 17-5 : High Level BFD – Area 3311 – Dense Medium Separation (Coarse)

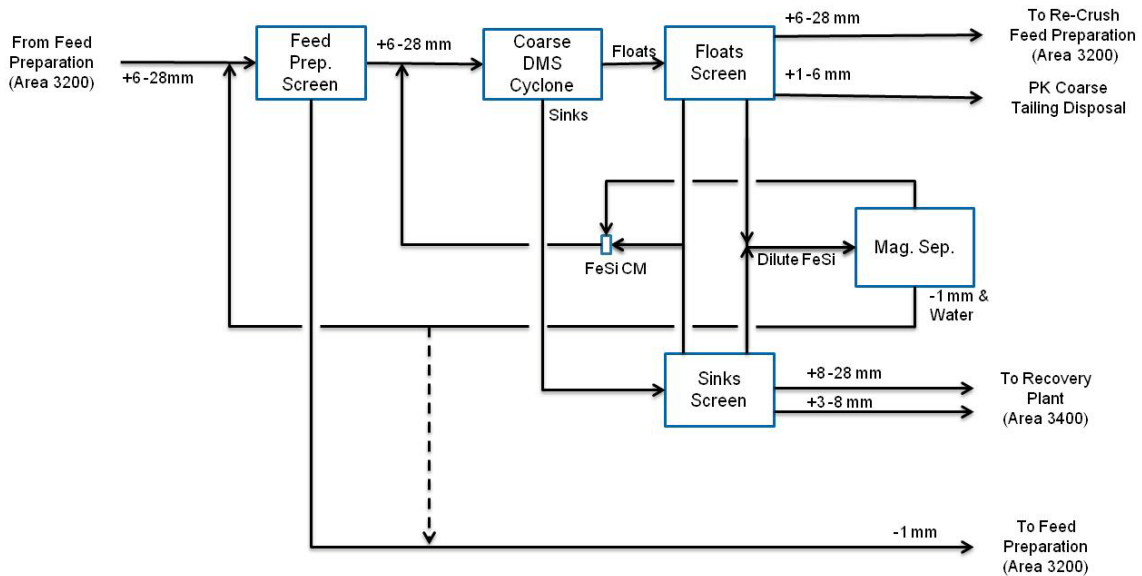
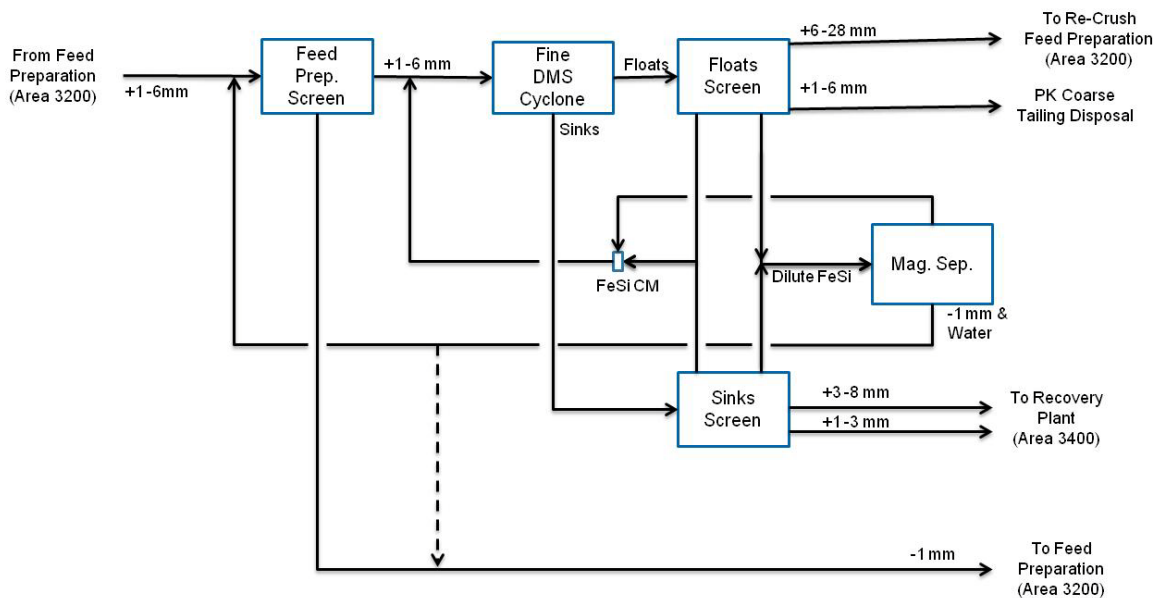

Figure 17-6 : High Level BFD – Area 3321 – Dense Medium Separation (Fine)



Both treatment lines have similar process flow diagrams. A fine and coarse DMS module was selected to optimize the diamond recovery.

Throughput can vary depending on how the ore crushes and the resulting split to fine and coarse DMS circuits. If the split is different from what was observed during testwork, then one of the circuits may become the plant bottleneck and force a reduction in plant capacity. Should this event happen, it can

be mitigated by changing screen size to balance DMS circuits (as long as the changes do not happen too often). Operations can also try to blend ore from different pits to minimize this problem.

The following process flow description is based on the coarse DMS module, while the fine DMS details are indicated in brackets.

Sized ore between -28 to +6 mm (fine: -6 +1 mm) is withdrawn from the 200 t Feed Bin via a belt weigh feeder and discharged onto the Feed Preparation Screen, where any remaining -1 mm material is removed and sent to the Feed Preparation area (scrubber).

The screen oversize material is discharged into a mixing-box, where the material is mixed with correct medium (CM) slurry (water and ferrosilicon (FeSi)). The material is pumped, via a VSD centrifugal pump, to the cyclone feed distributor (a single four-way distributor for the coarse DMS and a two-way distributor, followed by two three-way distributors for the fines DMS), and to the four 510 mm diameter (fine: six 420 mm) DM cyclones. The pump will be controlled through the pressure transmitters that will be installed at the cyclone distributor and inlets (DMS pressure control loop). The cyclones separate the ore into two products based on the density differences.

The overflow product will report through to the floats screen and the underflow product will report to the sinks screen. The floats screen is a double-deck screen, screening at 6 mm and 1 mm (d_{50}), respectively. Each screen will be fitted with a static screen prior to the vibrating screen (both static screens will cut at 0.8 mm). Spray water will be added to the rinse-side of the floats and sinks screens and will be controlled by a single, actuated valve. One manual valve per screen will be installed to adjust the spray water as required. The underflow from the static screen and the drain-side of the floats and sinks screens will report to the correct medium (CM) sump while the product from the rinse-side of the screens will report to the dilute medium (DM) sump.

Wet drum magnetic separators then recover the ferrosilicon from the dilute medium circuit and transfer it to the correct medium circuit for reuse. The magnetic separators' tailings stream is split into three streams, with the cleanest being sent to the floats screen as rinse water, the second-cleanest being sent to the feed preparation screen for pulping, and the final, dirtiest stream (due to entrained fine solids) sent directly into the effluent tank in the feed preparation area.

Pump-fed pipe densifiers are used to remove excess water from the correct medium circuit to maintain an elevated medium density (above the cyclone operating feed density – not shown in BFD) in the correct medium circuit. Raw water is used to lower and control the circulating medium density to the cyclone inlet density set point.

The cyclone overflow, or float material, is sized on a double-deck, drain-and-rinse, vibrating screen with cut-sizes of 6 mm and 1 mm. The +6 mm material discharges onto a conveyor and is transferred to the HPGR feed bin for re-crushing. The -6 mm + 1mm material is collected by another conveyor which discharges onto the coarse reject conveyor (combined coarse reject: DMS & coarse degrit tails – Area 3500) towards the coarse reject stockpile outside the plant.

The coarse reject stockpile has a capacity of 2,000 tonnes, or approximately 6 hours of plant operation. The coarse rejects are loaded by a front-end loader into trucks for disposal to the coarse rejects impoundment area.

The cyclone underflow, or sink material, discharges onto a horizontal single-deck drain-and-rinse vibrating screen located within the recovery plant for security reasons. The screen separates the concentrate into two size fractions: -28 +8 mm (coarse) and -8 +3 mm (middles) for the coarse module. Similarly, the size fractions produced in the fine module are -8 +3 mm (middles) and -3 +1 mm (fines).

The DMS concentrate is stored in four bins ahead of the recovery plant depending on the size fraction. Two bins are in each circuit:

- Coarse DMS : one coarse concentrate bin and one middles concentrate bin
- Fine DMS : one middles concentrate bin and one fines concentrate bin.

Floor drain pumps are provided within the DMS modules, and deliver their pumped streams to the floats screens.

For the make-up of lost medium, ferrosilicon will be mixed in a manual make-up system and discharged directly into the correct medium (CM) sump. The contents of the CM sump will be pumped to a static header-box, from which the mixing-box feed (mixing compartment and the pressure compartment) and the return to the CM sump will be derived. The densification circuit consists of pipe densifiers. The underflow material will be gravity-fed to the CM sump and the overflow material will be gravity-fed to the dense medium (DM) sump.

17.2.5 AREA 3400 – RECOVERY PLANT

17.2.5.1 GENERAL

The recovery plant process was designed by ADP based on the testwork results and their extensive experience in diamond recovery.

The purpose of the recovery plant is to treat the DMS concentrates and recover a diamond product for shipment off site to Yellowknife for final cleaning and NWT Government valuation.

Figure 17-7 presents the high-level block flow diagram of the recovery plant area. The area consists of similar treatment lines for the various concentrates produced up stream:

- fine concentrate (-3 +1 mm)
- middle concentrate (-8 +3 mm)
- coarse concentrate (-28 +8 mm).

Figure 17-7: High Level BFD – Area 3400 – Recovery Plant

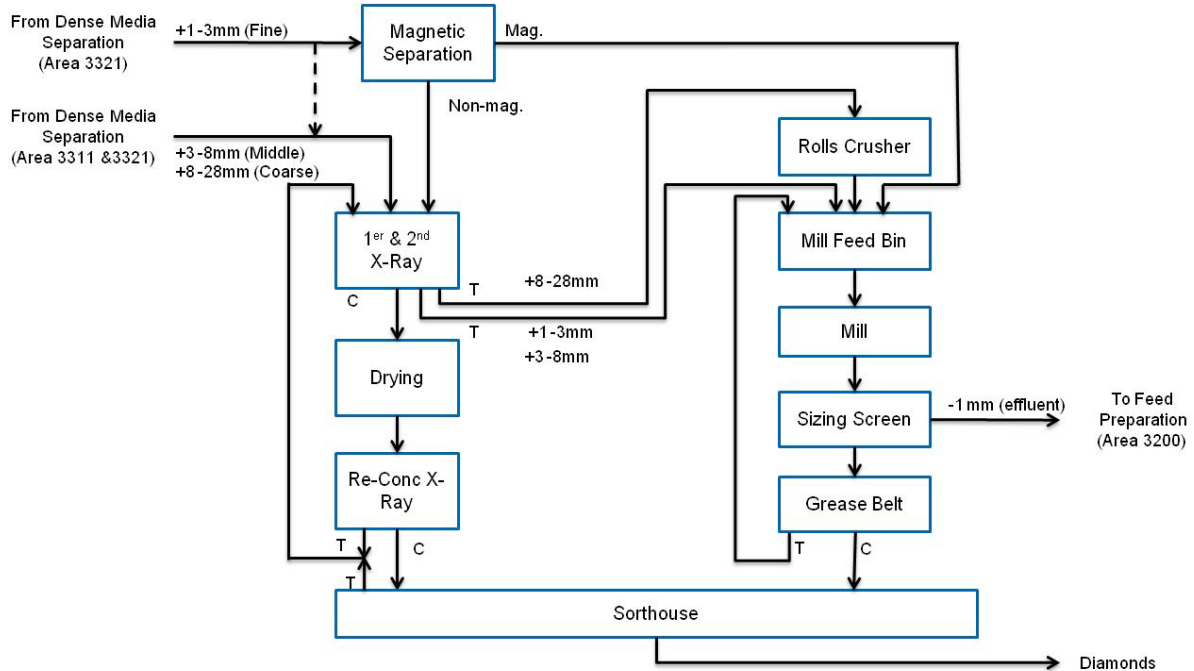

17.2.5.2 FINES MAGNETIC CIRCUIT

The fine concentrate is sent to fine magnetic separation to reduce the load on the downstream X-ray circuit. The option to by-pass the fine magnetic circuit and send directly to the X-Ray is available.

The fine concentrate (-3 + 1 mm) is withdrawn from the bin by a pan feeder to feed the first pass of magnetic separation belt. The non-magnetic material is sent by gravity to the second magnetic separation belt. The non-magnetic material is collected in a bin from which a jet pump carries the concentrate to the wet X-ray dewatering screen, which removes the motive water and sends the moist concentrate into a feed bin of the wet X-ray circuit (as describe above for the middle and coarse concentrate). The magnetic material from the primary and secondary magnetic separation is re-combined and sent to the mill feed bin by means of a tube feeder (scavenging circuit).

Consideration for a future middle magnetic circuit was planned if the load of middle concentrate overloads the wet X-ray circuit.

17.2.5.3 WET PRIMARY X-RAY MACHINES & DRYING

Four wet X-ray production lines are used to treat the DMS concentrate. Two lines are for the fine concentrate (-3 +1 mm), one (1) line is for the middle concentrate (-8 +3 mm) and the last line will be able to process middle or coarse separation (-28 +8 mm). All lines are similar from a process perspective, with any small variations mentioned below.

From the storage bin, a volumetric feeder withdraws the concentrate to be treated in the primary wet X-ray machine. The tails of the primary wet X-Ray machine are sent to the secondary wet X-ray

machine for further sorting. The concentrate of the primary and secondary steps are combined together in a storage bin.

The fine tails of the secondary wet X-ray are sent to the mill feed bin in the scavenging circuit. The middle and coarse wet X-ray machine tails (-8 +3 mm; -28 + 8mm) tails are sent to the roll crusher feed bin by a dewatering tube feeder.

A pan feeder withdraws the concentrates from the storage bins and sends it to the infra red (IR) dryers. The two fine concentrates are dried in a dual channel IR dryer. A similar dual channel IR dryer is used for the middle and coarse concentrates.

17.2.5.4 RECONCENTRATION X-RAY CIRCUIT

Discharge of the dryers (2 x dual channel) into a volumetric feeder feeds respective four re-concentration X-ray circuit lines.

The volumetric feeder discharge into the primary reconcentration X-ray, the concentrate of this step is sent by gravity to the secondary reconcentration X-Ray (2 pass) to produce a concentrate that falls into a dock lock. The dock lock is manually transported (procedure with protective services) to the single particle sorter – glovebox for coarse concentrate.

The tails of the primary and secondary reconcentration X-Ray Machines are conveyed back to the Dewatering Screen in the Wet X-Ray Circuit for re-processing and avoid any losses by utilising the vacuum transfer system.

17.2.5.5 SCAVENGING CIRCUIT – MILLING & GREASE BELT

Coarse and middle wet X-ray tails (-28 +8 mm; -8 +3 mm) are withdrawn from the storage bin to feed the roll crusher. The objective is to reduce the top size of the material for the mill downstream. The discharge of the roll crusher goes into the mill feed bin.

The mill feed bin also receives: fines tails from the wet X-ray machine (-3 + 1 mm), magnetic material from the fines magnetic circuit (-3 + 1 mm) and the grease belt tails (-8 +1 mm). A tube feeder withdraws the material from the bin to feed it to the preferential mill to allow liberation of potentially locked diamonds as well as milling the rejects below 1 mm for disposal. The discharge is pumped to a sizing screen that produces three streams. The undersize (-1 mm) is pumped to the secondary scrubber sizing screen or bypassed to the de grit dewatering screen for disposal by the coarse rejects conveyor. The rest of the concentrate is split in two size fractions (-8 + 3 mm; -3 + 1 mm) and is stored into two feed bins for treatment through the Grease Belt Circuit.

Pan feeders withdraw the material from the bins to feed the dual stream grease belt circuits. The grease belt circuit generates a concentrate that is sent to a dedicated grease belt concentrate glovebox for further sorting. The tails of the grease belt are sent back to the mill for re-processing.

17.2.5.6 SORTHOUSE

Reconcentration X-ray circuit concentrate enters the sorthouse via a diverter into secured (dock lock) containers. Fines concentrate is divided into two laser single particle sorters. The tails of the single particle sorters passes through a second pass of ultra violet single particle sorter that will be utilised in a scavenging application. The middle and coarse concentrate are sent to one pass of laser single particle sorter.

17.2.5.7 RECOVERY ANCILLARIES

A closed, chilled water circuit will be used for cooling the X-ray tubes. A motive water internal loop is used for the jet pump circuit.

Raw water, process water, compressed air services will be supplied from the main process plant.

17.2.6 AREA 3500 – THICKENING

The purpose of the Thickening area is to separate the water from the solids in the effluent streams and return clarified water to the process water tank (in the main plant) and waste solids to disposal.

Figure 17-8 presents the high-level block flow diagram of the thickening area.

Figure 17-8: High Level BFD – Area 3500 – Thickening Area

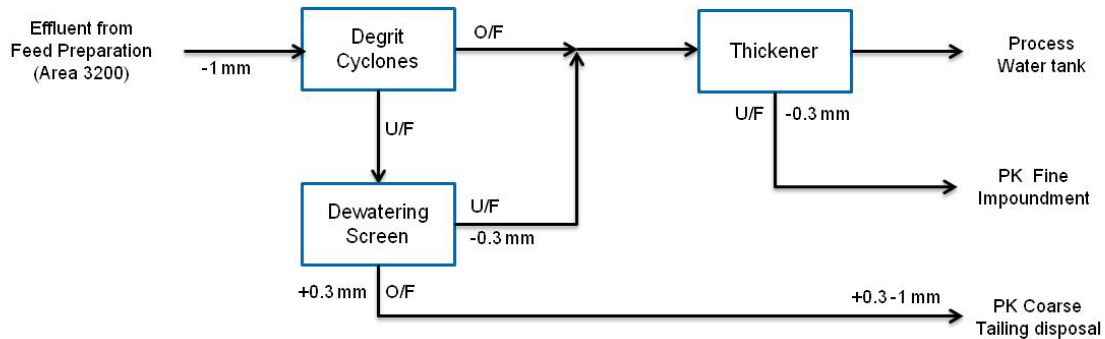

The plant effluent streams containing -1 mm solids are collected and pumped to the degrit cyclones that separate the solids at ~150 µm.

The degrit cyclone underflow (-1 mm +150 µm) discharge to a 300 µm aperture de-watering screen. The screen oversize discharges onto a conveyor that combines to the coarse rejects from the DMS (Floats -6 +1 mm) and is directed towards the coarse stockpile outside the plant.

The degrit cyclones overflow and de-watering screen underflow are collected and pumped to the thickener distribution box.

Flocculent will be added to the thickener distribution box to aid fine solids settling in the thickener.

Thickener overflow flows to the process water tank.

The thickener underflow slurry density will be controlled to a required set point, and the flow transferred to the fines rejects pump box where variable speed pumps pump 2 km to the fine PK impoundment area.

17.2.7 AREA 3600 – PROCESS PLANT, WATER & AIR

The purpose plant utilities area is:

- to supply and provide storage for plant distribution of the reclaim, raw water (including the fire water reservoir), and the process water
- to supply compressed & instrumentation air for the various user of the plant.

Figure 17-9 presents the high-level block flow diagram of the utilities area.

Figure 17-9: High Level BFD – Area 3600 – Utilities Area

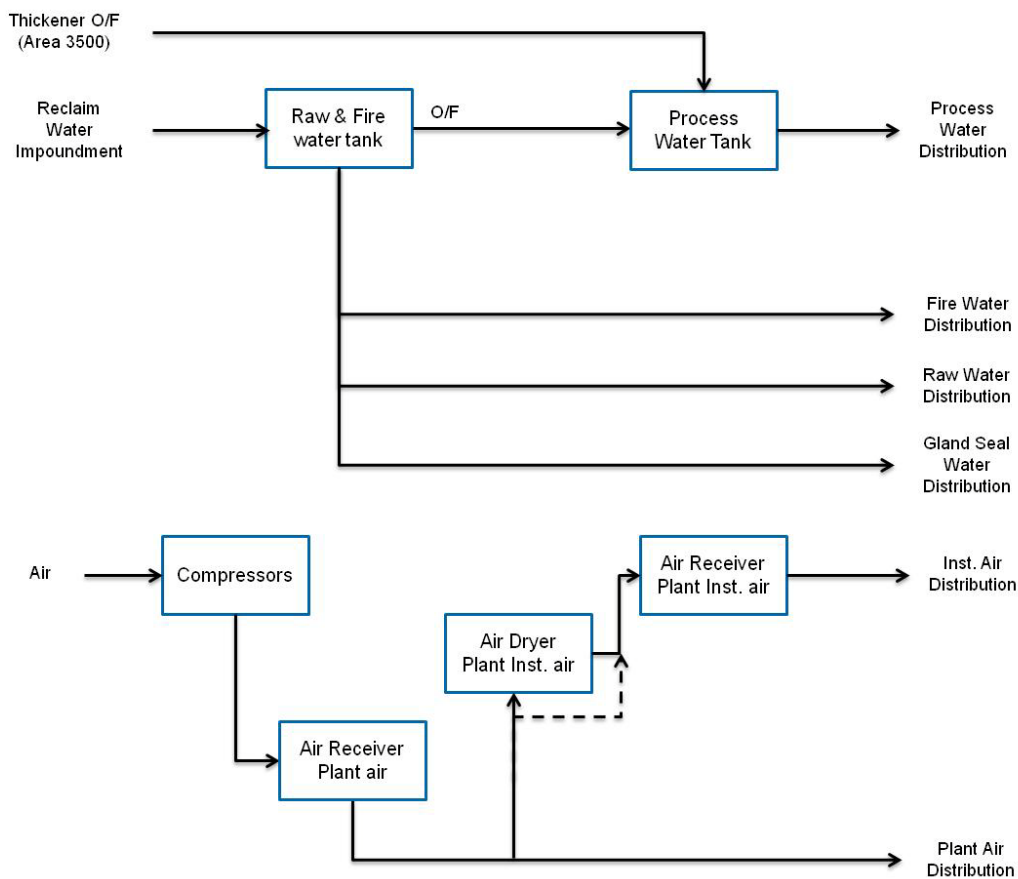

Separate water tanks are required for raw/fire water and process water.

Raw water use is limited to where clean clear water is required (e.g., flocculent mixing, pump gland sealing, recovery plant, chilled water and wet scrubbers).

The upper portion of the raw water tank supplies this water, while the lower half serves as a dedicated reserve for the fire water distribution system.

Process water (thickener overflow) reports to the process water tank and is used for all other processing requirements (e.g., cone crusher, scrubber, screen sizing, and ferrosilicon rinsing).

Make-up water for the process is provided by an overflow from the raw water tank.

Pumps maintain the required pressures and flows to the process.

Dry, oil-free compressed air is supplied for instrumentation throughout the plant.

Compressed air is supplied for maintenance purposes and for agitation in the DMS correct medium pump box.

17.3 Process Design Criteria & Quality

This section presents a summary of the main criteria used for the plant design for various areas of the plant. Values in Table 17.2 will vary or be adjusted depending of equipment selection at the next phase of engineering, and therefore, they are presented as a guideline only.

Table 17.2: Design Criteria

Description	Min	Ave	Max	Units
<i>Primary Ore Crushing – Area 3100</i>				
Top size from mine			1400	mm
Top size to primary crushing – (grizzly cut size)			900	mm
Top size to secondary crushing – (target)		250		mm
<i>Feed Preparation - Area 3200</i>				
HPGR crusher feed size - target	1		75	mm
Degrit cut size - target		1		mm
Size fraction to DMS – Fine DMS	1		6	mm
Size fraction to DMS – Coarse DMS	6		28	mm
<i>DMS area – Area 3300</i>				
DMS modules	1 Coarse & 1 Fine			text
Medium Type	FeSi – 150D – 270 D			text
Coarse DMS – FeSi Medium to ore ratio	5:1			vol/vol
Fine DMS – FeSi Medium to ore ratio	7:1			vol/vol
Fine Process Kimberlite (PK) impoundment			0.3	mm
Coarse Process Kimberlite (PK) cut size (float screen)	1		6	mm
Coarse Process Kimberlite (PK) cut size (de-watering screen)	0.3		1	mm

17.4 Plant Control Philosophy

The Gahcho Kué plant processes will be automated to allow high-quality production with minimal human intervention.

The Instrumentation and Control systems must be capable of providing the information and control necessary to operate the plant safely, efficiently, and economically.

The design of the Instrumentation and Control system will allow for the control and monitor of all field instrumentation, motors, and actuators from a central control room using a basic process control system (BPCS). The BPCS will be based on programmable logical controllers (PLCs) and human machine interfaces (HMIs).

The instrumentation and control system will be designed for fail-safe operation and allow for fault diagnosis and reporting.

Control valves will be pneumatically operated. Mechanical equipment shall comply with Z432 – safeguarding of machinery and include all necessary safety devices (E-Stop, Pull cords, etc.)

The plant will be controlled from a central control room. This control room shall be located in a strategic location to provide a clean, safe and air conditioned operating environment and will be manned 24/7.

The PLCs and control system servers and communication devices will be installed in an air-conditioned server room adjacent to the control room. The access to the server room will be restricted.

The engineering station will be located in a separate restricted room, located beside the control and the server rooms.

17.5 Process Plant Facilities Description

The process plant is oriented along an east-west axis. Plant feed is introduced near the middle of the plant length. In the middle of the plant is located the secondary cone crusher, the scrubbers and primary screening. On the west side of the plant is located the HPGR, water tanks and the thickener. On the east side of the plant is located the dense media separation modules and, in a separate building within the plant, the recovery. Coarse PK tails leave by conveyor from the north side of the plant.

Two 30 t overhead cranes, with a 5 t auxiliary hoist, will service the building.

Fire water pumps are located in a modular building on the north side of the process plant.

Compressors are located in a modular building on the south side of the process plant.

The security system divides the plant into “red” (recovery plant/sorthouse; high-security) and “blue” (remaining plant; lower-security) areas. The red area is physically separated by steel cladding walls from the rest of the plant. All wall penetrations are sealed. Authorised entry and exit is controlled by fingerprint identification and a system of inter-locking doors. In addition, facilities are in place for the random selection of personnel exiting the blue area for additional search. Mandatory search will be in effect for exit from the red area. Normal access to the plant (red and blue zone) is done through the PCC building located at the east side of the process plant.

SECTION 18 PROJECT INFRASTRUCTURE

18.1 Introduction

The Gahcho Kué site is typical of many northern Canadian mining operations that lack local and regional infrastructure such as permanent road access, navigable shipping routes and ports, and external utilities. Therefore, the Gahcho Kué site requires extensive infrastructure to sustain operations, including power generation, sewage and water treatment, personnel accommodation, storage facilities for materials delivered on the limited annual winter ice road, and an aerodrome to provide year-round cargo, food and passenger aircraft access.

The design approach for the Gahcho Kué site infrastructure will incorporate features common to other northern mining developments:

- Permafrost conditions will be considered in foundation designs, especially for settlement-sensitive structures and equipment. Major plant structures will be founded on bedrock and lesser structures on socketed steel pipe piles. The single-storey accommodation facilities and similar trailer units will be erected on a pads consisting of crushed and compacted mine rock.
- The airstrip and apron will be constructed from crushed, screened and compacted layers of mine rock.
- Electric power will be provided by a stand-alone modular diesel generating plant.
- Storage facilities/areas for consumables and spare parts will be sized for one year's supply requirement (e.g., diesel fuel, ammonia nitrate, cement, and, ferro-silicon, operating and capital spares).
- Exhaust gasses (waste heat) from diesel generators will be recovered to the maximum practical extent and used for heating the plant site buildings.
- Major buildings, including the process plant, accommodations complex, service complex, and power plant, will be connected by enclosed, heated utilidors so personnel can access these facilities without going outdoors. The utilidors also provide support and routing for utilities such as piping, power, control and communications cables.

- Depending on function, fixed equipment will be located in heated or unheated structures. Personnel safety during construction, operation and maintenance is a prime consideration in plant layout.
- Piping for outdoor water, sewage, and slurry lines will be insulated and heat-traced (as required).
- Construction labour and indirect costs are typically relatively high in this region. Wherever practical, to minimize site erection time, equipment and buildings will be pre-assembled off site and delivered to site as modules or on skids.
- Common support services such as potable water, fire water, and sewage treatment will be provided as stand-alone equipment and systems. Waste generated from operations will be managed on site. Depending on category, wastes will be landfilled, incinerated, or shipped off site for proper disposal at approved facilities.
- Facility layout will accommodate snow clearing.
- Electrical grounding systems will be suitable for permafrost conditions.

18.2 Site Layout

The layout of the site is based on several criteria:

- all major structures to be founded on bedrock
- compact footprint for minimal land disturbance and maximum site operations efficiency
- compact building sizes and layout for maximum energy efficiency
- efficient facility access for personnel and vehicles during construction and operations
- minimal impact of winter road truck traffic around the site.

The overall site plan and plant site layout are shown in Figure 18-1 and Figure 18-2.

The site can be loosely divided into the following areas.

- accommodations complex, process plant, power generation, fuel storage and truckshop, located in the centre of the site
- airport, located to the south of the site
- Tuzo, 5034 and Hearn pits, located on the west side of the site
- west and south mine rock piles, located on the west side of the site
- coarse processed kimberlite (PK, tailings), located just north of the process plant
- fine processed kimberlite (PK, tailings), located north of the site.

Figure 18-1: Overall Site Plan

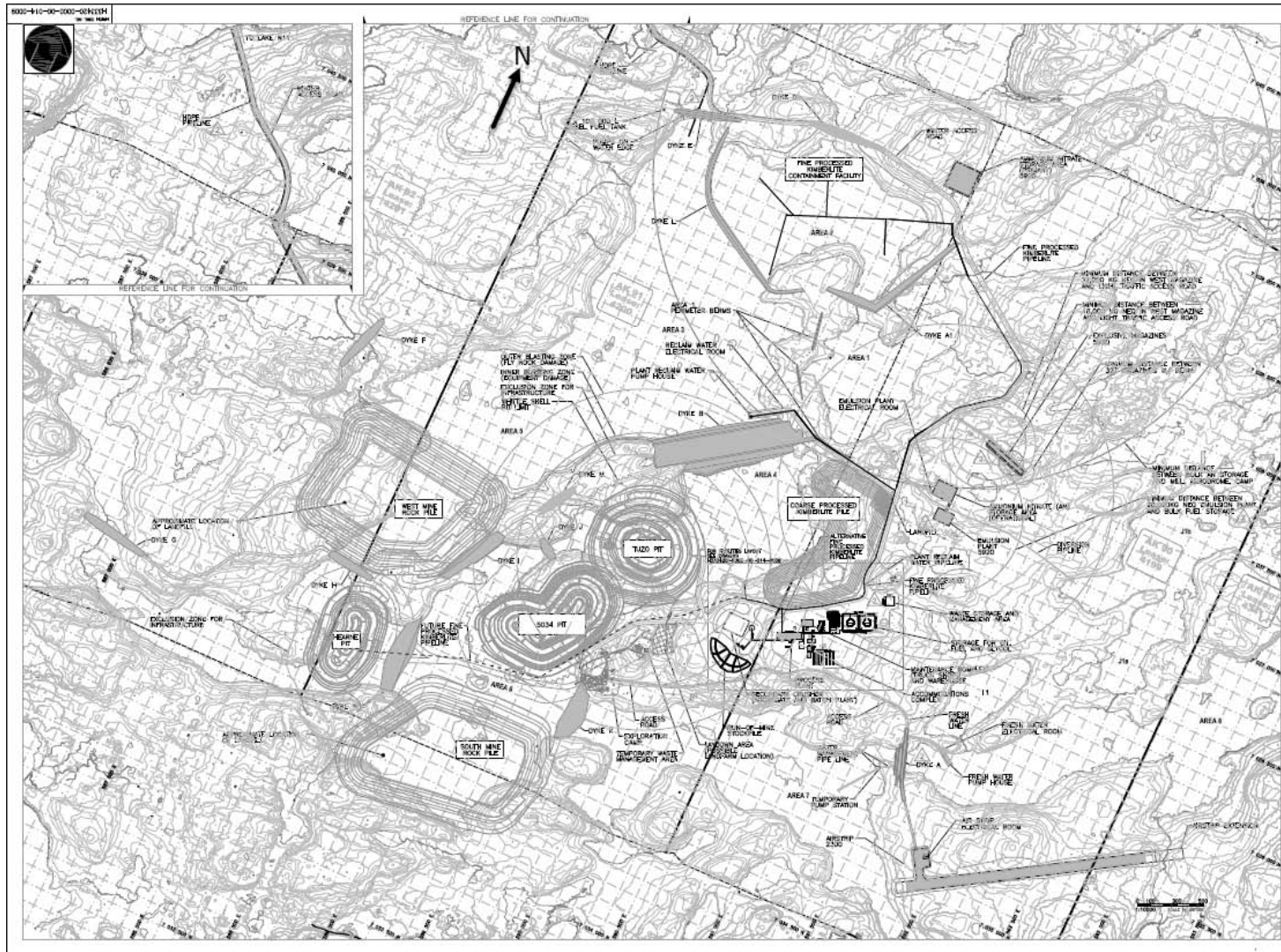

Miscellaneous ancillary facilities are located throughout the site, including aggregate crushing, concrete batch plant (for construction only), sewage treatment module, incinerator module, ammonium nitrate storage, bulk emulsion plant, and explosive storage magazines.

Various dykes are also spread throughout the site to allow water management.

18.3 Power Distribution

Power distribution will generally be at 4.16 kV, with lesser loads supplied at 600 V. All plant site distribution will be cable run within the utilidors as much as possible. Cable required for the outlying areas will be run along the ground. The cables will be suitably marked for safety purposes and to prevent damage.

The 4.16 kV feeders originating at the power plant will be distributed to area substations throughout the site. These area substations step voltage down to 600 V for distribution to MCCs and power panels as required.

18.4 Fuel Supply, Storage & Distribution

The Gahcho Kué tank farm is designed for the storage and dispensing of diesel and oils, such as:

- diesel fuel to feed all equipment and engines within the entire plant.
- fresh and used lube-oil, fluids, glycol.

These liquids will be stored in:

- three 18,000 m³ main storage fuel tanks
- eight 500 m³ fuel tanks
- ten 60 m³ multi-usage tanks.

The tank farms are bermed. Two of the 18,000 m³ tanks will be constructed during the capital construction phase. The third tank will be constructed during the operations phase.

18.5 Camp & Administration Office Complex

The construction/permanent camp and administration office complex will include the following:

- dormitory units
- kitchen and food storage
- dining room
- arrivals/departure building including reception and first aid
- recreation facilities and gymnasium

- administrative office building including mine engineering offices, mud dry and lunchroom
- utility rooms (mechanical, electrical, domestic potable/hot water, fire protection)
- laundry
- maintenance workshop
- heated fire truck /ambulance garage
- IT/server room
- water treatment plant
- sewage treatment plant
- two incinerators located remotely and adjacent incinerator building
- personnel control centre (PCC) building, including the process plant change rooms (blue area).

The complex will be pre-fabricated modular-type construction designed for arctic weather conditions. Ground-level heated and insulated utilidors will connect the complex to the other plant site buildings (except for the sewage treatment plant and incinerators that will need to be accessed from outside).

18.6 Truck Shop & Warehouse Facilities

The remote location of Gahcho Kué requires that all routine maintenance of the mobile production and service equipment be carried out on site. To effectively accomplish the task a fully equipped workshop, warehouse, offices and trained staff will be required.

The truck shop has been designed to meet the needs of servicing and maintaining mine production equipment, as well as the mobile mine and plant support equipment.

Apart from the heated warehouse located within the truck shop, a heated warehouse will be installed on the southeast side of the process plant. It will be connected to the utilidors.

Process plant equipment and supplies requiring weather protection will be warehoused within the process plant building as close as practical to their end use or in the heated warehouse.

Designated space is allowed for in the camp/administration complex for the storage of dry goods. Refrigeration and freezers are provided for perishables.

18.7 Ancillary Facilities

Ancillary facilities required for the operation of the mine are as follows:

- Aggregate crushing plant
- Concrete batch plant
- Sewage treatment module

- Incinerator module
- Ammonium nitrate storage
- Bulk emulsion plant
- Explosives storage magazines
- Environmental laboratory.

18.8 Aerodrome

The gravel strip aerodrome has been designed to Transport Canada specifications for landing approach angle, runway lighting, lighted windsocks, standard and RNav GPS approach, non-directional beacon, AWOS and VHF radio facilities. The aerodrome will also be outfitted with an aircraft radio control of aerodrome lighting unit (ARCAL).

Extension for a strip length suitable for a 737-type jet aircraft has been designed for; however, the initial airstrip length will be limited to use by propeller aircraft up to a Hercules in size. Extension of the length of the runway to accommodate 737 aircraft is possible given the current orientation.

18.9 Roads

18.9.1 WINTER ACCESS ROAD

The winter access road will link the project site with the existing Tibbitt-to-Contwoyto winter road at MacKay Lake. A 120 km winter access road spur off the north end of MacKay Lake will be constructed each year to connect the project site to the Tibbitt-to-Contwoyto winter road at km 271, just north of Lake of the Enemy. The winter access road will be constructed and operated in accordance with license and regulatory conditions and with appropriate updates and improvements as required.

18.9.2 SITE ROADS

Site haul, access and service roads will be constructed using crushed and screened mine rock, as well as suitable overburden material. Site roads have been classified into four types, each with specific design requirements. The four types of roads are as follows:

- Mine Haul Road: Primary haulage routes on site, excluding in-pit and waste dump roads designed to 3x the width of the 218 t haul fleet.
- Main Access Road with Pipe Bench: Access to mine site facilities from winter road with a bench for fine PK pipeline.
- Service Road Type 1: Used to access primary site infrastructure 10 m.
- Service Road Type 2: Designed to all types of service vehicles (8-10 m).

All running surfaces will be constructed with a 2% crown. Fill slopes will be set to 3:1 for mine haul roads, and 2:1 for all other roads with all cut embankments at 0.25:1. Road materials will be a mix of

till material and run of quarry blast rock for fill and sized crush rock for surfacing. The structure of the mine haul roads will include a 300 mm road surface comprised of 40 mm minus gravel, this surface will be placed on top of a minimum fill embankment of 1700 mm run of quarry or till. All other roads will be constructed with a 250 mm road surface comprised of 20 mm minus gravel placed on top of a minimum 1,250 mm of quarry rock or till fill.

It is expected that regular grading and levelling using crushed gravel will be required to keep the roads in an acceptable condition to reduce wear and tear on the trucks and tires.

18.10 Fire Protection System

Fire protection for each facility in plant site area consists of a combination of hydrant/hose stations, sprinkler systems, heat and smoke detection and, portable chemical fire extinguishers. Fire fighting water is provided from a dedicated storage tank and fire pumps.

As part of operations, emergency response / fire fighting teams will be recruited from operations personal. Training by professional fire fighters will be an ongoing requirement.

The self-contained fire truck, listed with the mine mobile equipment, will be available to attend all site emergencies.

SECTION 19 MARKET STUDIES & CONTRACTS

19.1 Diamond Pricing and Market Studies

JDS has relied on WWW International Diamond Consultants (WWW) for diamond valuation. WWW are recognised international leaders in this field and are the valuers to the Federal Government of Canada for the Canadian diamond mines in the Northwest Territories. This information was used in support of Sections 14, 15, and 22 (reserves and economic analysis). The valuation carries with it a reliance on diamond SFDs (sizes frequency distributions) for pit/facie groupings, along with modifying factors, as described in this report. JDS accepts that it is reasonable to rely on the combination of the De Beers SFDs and modifying factors and the WWW valuations.

Similarly, JDS has relied on De Beers and MPV for the diamond price escalation estimate. De Beers and MPV conducted their own market analysis and determined that a 1.5% real growth rate in US\$ diamond prices be used in the financial analysis. JDS reviewed other diamond escalation estimates and are of the opinion that the 1.5% is a reasonable assumption for current market conditions.

19.1.1 DIAMOND VALUATIONS

JDS is not able to apply quality control measures to the valuation process performed by either De Beers or WWW International.

The reason for this is that diamond valuation is, at best, only partially analytical (in the way that a gold assay process can be termed analytical), as the diamonds are sieved and subjectively classified by colour, clarity, etc. The dollar per carat determinations for various stones, however, is ultimately governed by the valuator's price-book. This part of the process is proprietary, governed by a given valuator's view of the marketplace and can vary from valuator to valuator, particularly for larger stones. Even in larger parcels, valuers must then 'model' or extrapolate values in the larger stone size classes where there may be limited representative samples sizes. The methodology for modelling is also proprietary.

These diamond valuation procedures do not lend themselves to quality control measures that a Qualified Person could apply as with a commercial assay laboratory. At every step, JDS is relying on the valuator's opinions of the diamond market and their subjective view of diamond values.

JDS also rely on the valuator's models, which are heavily dependent on their view of the diamond market, their proprietary estimates of the likelihood of finding larger stones in the deposit because of sample-size support, and the perceived value of those larger stones.

The culmination of the process is the average prices for given zones, lobes or pipes. The heavy dependence of the process on economic market assessments, and the proprietary nature of the valuator's assumptions and methods, materially affects the quality of, and confidence in, the Mineral Resource estimate. In this way, the valuations used in the Mineral Resource assessments are markedly different than the concept of analytical mineral assays in, for instance, a precious metal project. The proprietary nature of the processes employed for valuations limit any quantitative assessment of the added risk to the project. Other than reviewing the De Beers' data and the WWW report for transcription errors in the transfer of the valuation figures into the database, no other data verification procedures can be applied.

Diamond valuers are experts, but not Qualified Persons, and the Qualified Persons preparing the Mineral Resource estimates and assessing the reasonable prospects for economic extraction have had to completely rely on the De Beers SFDs and WWW diamond values provided.

19.1.2 2014 DIAMOND VALUATION EXERCISE

In February 2014 Mountain Province Diamonds (MPV) retained the services of WWW International Diamond Consultants (WWW) to re-price diamonds recovered from bulk sampling of the Gahcho Kué Project and update the modelled values of average price (AP = dollars per carat). WWW last valued these diamonds in April 2011 and carried out a re-pricing and re-modelling exercise in March 2012

The re-pricing and modelling exercise are based on the WWW price book as at 24 February 2014. (Non-public Report: *Re-Price & Modelling of the Average Price of Diamonds from the Gahcho Kué Diamond Project – February 2014*)

WWW valued 8,317.29 carats from four separate bulk samples in April 2011. These samples have been re-priced using WWW's proprietary price book as at 24 February 2014 giving a total value of US\$1,445,068 and a combined AP of US\$174 per carat.

These models are based on the SFD models produced by De Beers based on a 1.00mm bottom cut off, and are based on the diamond market as at 24 February 2014.

De Beers produced the SFD models from their micro-macro grade models and apply modifying factors for recovery efficiencies and bottom cut off if applicable (see description in Item 14- Mineral Resource Estimates).

The terms "minimum" and "high" have been used deliberately and are explained as follows:

- Based on analysis of the bulk samples, WWW believes it is highly unlikely that the average price for the four zones will be lower than the minimum values shown in Table 19.1.
- In the larger sizes the modelled values could be higher than those used in the "high" models. (i.e. the high values are not maximum values.)

- For mine feasibility studies WWW recommends using the base case models for defining the resource/reserve. The “minimum” and “high” models are included for sensitivity analysis.

Table 19.1: Summary of WWW February 2014 Diamond Prices

Pipe	Sample	High Model	Model	Min Model
5034 Centre	196	167	132	114
5034 West	102	172	131	118
5034 NE	196	194	142	120
Hearne	88	137	107	97
Tuzo	298	134	101	95

Note: All prices in \$US/carat

The primary case for the economic analysis is based on the Model prices in \$US for 2014 as summarised in Table 19.2. To clarify the naming conventions used elsewhere and reflect the prices assigned to the pit/facie combinations referred to in the mine schedule and described/determined in the reserves section, note the following:

- 5034 Centre..... 5034-CP
- 5034 West5034-WP and 5034-ST
- 5034 NE 5034-NE and 5034-NT
- Hearne.....Hearne
- Tuzo..... Tuzo

Table 19.2: Summary of Diamond PricesUsed in Economic Analysis

Pit (and zone)	WWW Price
5034-CP	132.00
5034-WP	131.00
5034-NE	142.00
5034-NT	142.00
5034-ST	131.00
Hearne	107.00
Tuzo	101.00

JDS has reviewed the WWW diamond valuation report and made comparisons to the latest diamond pricing information provided by De Beers and as such, it is JDS’ opinion that the WWW diamond values represent a “reasonable price level’ to use as a basis for the economic analysis. Notwithstanding the

“reasonable price level”, JDS notes that diamond price estimates represent a viewpoint at a given point in time and may not accurately reflect realised prices over the life of the mine operation.

19.2 Contracts

A number of supply and service contracts have been established or are in the process of being established in order to advance the pioneering activity currently underway at the project site and, in anticipation of receiving final permitting, to support the smooth transition during construction thru to the initial operating period. These contracts are issued by De Beers Canada as the designated Operator of the GK Joint Venture Agreement.

Aside from the JV Agreement, the supply and service contracts, while relevant for timely, cost effective advance of the project, the contracts are not uniquely material to the issuer.

For the sale of diamonds, De Beers and MPV each have the respective rights to 51% and 49% of the diamonds recovered. The project analysis assumes diamond sales to the project at the time of the govt valuation process and purchase of “specials” in accordance with the JV agreement [Essentially, each partner gets their share (purchases from the GKJV Project) at time of valuation (10 times per year) and then each partner will bid on the specials (10.8 carats and greater) to be awarded to the highest bidder and shared at that value according to respective rights. This facilitates a regular and relatively quick period for transactions, and provides cash flow to the project to avoid adverse impact to revenue/cashflow as a result of an individual partner’s marketing/sales strategies]. As such, the economic analysis excludes individual partner’s sales/marketing costs beyond the time of sale by the GKJV at the valuation cycles.

The supply and service contracts are awarded based on a competitive bid process to ensure that terms, rates/ charges are within industry norms with relevance placed on northern suppliers. Contracts falling within this group include, but are not limited to:

- Site Services; Master Service Agreement (MSA) in place
- Winter Road Construction & Maintenance; Contract in place
- Air Freight; MSA in place
- Fuel & Lube Supply; Contract in place for construction period
- Bulk Diesel Delivery (Winter Road); Contract in place
- Ground Freight (Cargo); MSA in place
- Charter Passenger Air; MSA in place
- Explosive Supply & Emulsion Plant Ops; LOI in place, phased contract details pending
- Equipment Maintenance (Mobile); Phase 1 underway, Phase 2 advanced/pending
- Ground Engaging Tools Supply; Interim supply

- Tires Supply; Global Framework Agreement in place
- Onsite Medical Services; MSA in place
- Camp Catering Services; Contract signed
- Tires Service; Contract signed
- Engineering Design Services – contracts signed
- EPCM Project Management Services – contract signed
- Environmental Consulting Services – contract signed.

In addition, purchase orders for equipment and materials have been purchased, or committed to purchase by the operator. These items were purchased on a competitive bid basis and include but are not limited to:

- Major mobile mining equipment – PO signed
- 14MW Diesel Power Generation Plant – PO signed
- 252-room Accommodation/Administration complex - PO/contract signed, camp delivered
- Diesel Fuel Storage Tanks – contract signed phase one tanks delivered
- Major Diamond Processing Equipment – various PO's signed.

SECTION 20 ENVIRONMENTAL STUDIES, PERMITTING, & SOCIAL OR COMMUNITY IMPACT

20.1 Environmental Impact Review Process

20.1.1 PROCESS SUMMARY

Part 5 of the *Mackenzie Valley Resource Management Act* (Canada) (the Act) established a process comprising an initial screening, an environmental assessment, and an Environmental Impact Review (EIR). De Beers Canada Inc. (De Beers) filed an application containing a Project Description with the Mackenzie Valley Land and Water Board (MVLWB). Following screening of the Gahcho Kué Project in December 2005, Environment Canada referred this proposed diamond mine to the Mackenzie Valley Environmental Impact Review Board (MVEIRB) for an environmental assessment.

In March 2006, the MVEIRB staff conducted a three-day issues scoping workshop in Yellowknife with federal and territorial government agencies, Aboriginal groups, who identified and classified environmental and social issues related to project. The MVEIRB staff also conducted four one-day issues scoping workshops in the communities of Detah, Łutselk'e, Fort Resolution, and Behchokö in April 2006. The results of these workshops were used, in part, to develop the Terms of Reference for the project's Environmental Impact Statement (EIS).

On June 12, 2006, the MVEIRB concluded that the project would likely cause significant public concern and recommended that an EIR be conducted. This was the first time that a proposed diamond mine was to be assessed by an EIR.

The MVEIRB appointed the Gahcho Kué Panel (the Panel) on May 2, 2007. The Panel is an independent body responsible for assessing the potential impacts of the project. The final "Terms of Reference for the Gahcho Kué Environmental Impact Review Panel" was issued on June 12, 2007. The Panel issued a work plan for the EIR, and the proposed Terms of Reference for the EIS was circulated so that De Beers and other participants could provide comments. The final Terms of Reference for the EIS was released on October 5, 2007.

Since the initial application and submission of the Project Description, and the release of the Terms of Reference, the specifics of the Project Description evolved which required additional engineering and environmental studies. In May 2008, De Beers temporarily deferred the filing of the EIS.

De Beers submitted the EIS for the project to the MVEIRB on December 23, 2010. The Panel reviewed the EIS in accordance with the Terms of Reference and issued a deficiency statement to De Beers on March 17, 2011, indicating that five main items needed to be better addressed before the review could proceed. De Beers subsequently submitted responses to the Panel's EIS deficiency statement on May 3, 2011 and July 15, 2011, including updates to Sections 8, 9, and 10 of the EIS. On July 26, 2011, the Panel found the EIS in conformity with the Terms of Reference.

EIS analysis sessions were held from November 28 to December 2, 2011. Following these meetings, parties prepared and submitted information requests to De Beers. De Beers responded to the information requests in March and April 2012. On April 23, 2012, De Beers submitted an EIS Supplement that included an updated Project Description, and associated revisions to the EIS.

Technical sessions were held from May 22 to 25, 2012. Following these sessions, a second round of information requests was held. De Beers responded to these information requests in August and September 2012. The parties submitted technical reports in October 2012, and De Beers responded to the technical reports in November 2012.

The Panel conducted the EIR hearings from November 30 to December 7, 2012. Community hearings were held in Dettah on November 30 and Áutsel K'e on December 3, 2012, and the public hearings were conducted in Yellowknife from December 5 to 7, 2012. Following the public hearings, parties including De Beers submitted closing statements for consideration by the Panel. The Panel deliberated from January 4 to July 19, 2013.

The Panel submitted their Report of Environmental Impact Review and Reasons for Decision on July 19, 2013. The Panel recommended to the Minister of Aboriginal and Northern Development Canada (AANDC) that the project be approved subject to the measures, follow-up programs, and developer commitments outlined in the report. The Minister has distributed the Panel's report to every responsible minister for consideration. On October 22, 2013, the Federal Minister approved the project. The project has entered into the formal permitting and licensing phase.

De Beers submitted a Land Use Permit (LUP) application to MVLWB on October 22, 2013 to undertake preliminary early or pioneer work in preparation for the development of the Gahcho Kué Project. The MVLWB issued the LUP on November 29, 2013. On November 28, 2013, De Beers submitted an application for the Type A Land Use Permit and Type A Water Licence for the full Gahcho Kué diamond mine development. On December 6, 2013, the MVLWB posted the application including the draft work plan to the public registry. The work plan outlines and defines the regulatory steps and timelines required to obtain the Gahcho Kué Project Land Use Permit and Water Licence.

De Beers has also made an application to Fisheries and Oceans Canada (DFO) for an authorization under the *Fisheries Act* to undertake the activities that impact fish habitat, recognising that additional consultation and documentation will be required for DFO to prepare the *Fisheries Act* Authorization. An application will also be submitted to *Navigation Protection Act* for authorization of facilities to be constructed within navigable waters.

20.1.2 PROCESS-RELATED RISKS & MITIGATION

20.1.2.1 PROCESS-RELATED RISKS

The primary risks related to the Land Use Permit and Water Licence include the following:

- schedule delays
- unfavourable Regulatory Agency, Board, and Ministerial decisions.

The primary potential causes of schedule delays include the potential risk that:

- updates to the Project Description (since the Ministerial Approval), could require additional screening by the MVLWB with the potential to extend the regulatory timelines
- additional technical studies are required by participants in the technical reviews due to differences in expert opinion, which could involve gathering more field data or undertaking additional environmental modelling assessments
- delays in regulatory process and accessibility, for various reasons, such as the timing and implementation of Northwest Territories Devolution Act, MVRMA and *Fisheries Act* regulations.

20.1.2.2 MITIGATION

Potential risks have been mitigated through Aboriginal group and regulatory engagement. Additionally, De Beers submitted a letter to MVLWB indicating that the modifications presented in the updated Project Description (since Ministerial Approval) were contemplated as part of the overall environmental impact assessment. The letter supports the case that the application should be exempt from preliminary screening. That is, the modifications to the mine plan since 2010 are not expected to change the conclusions of the EIS that no significant adverse effects will occur as a result of mine activities during construction, operation or dewatering phases.

As part of De Beers' on-going engagement strategy, De Beers will keep key government stakeholders informed as to the status of the project, with a view to helping them expedite the permitting review and approvals process. The regulatory engagement activities will include individual meetings with various senior regulators, workshops, and technical meetings with agencies representatives, as required.

In keeping with the primary objective of the regulatory engagement, the updated Project Description demonstrates that the project has evolved over the previous 8+ years; the changes to the mine plan in that time have focused on improving the feasibility and sustainability of the project, with supplemental environmental design features incorporated into the mine plan to improve mitigation of potential environmental effects and make sure that the environmental assessment is still appropriate. Workshops and technical meetings will also present the approaches described in the monitoring programs and management plans that have been developed alongside the updated project Description. These documents provide details that will become conditions of the Land Use Permits and

Water Licence so that the project meets its obligations to operate in an appropriate manner and reduce any potential risk of adverse effects to the environment.

Experience gained from regulatory processes associated with other projects in the north allows De Beers to anticipate, and prepare for potential issues or concerns. It should be noted that a number of the updates to the Project Description have resulted from developer commitments, such as increases to the size and depths of the pits, which are a result of recent drilling programs. These changes have been reflected in the Updated Project Description, as well as in the various supporting management plans. De Beers does not expect that these updates will result in changes to the regulatory process because they are not expected to result in changes to the conclusions of the environmental assessment; however, the possibility exists. As such, De Beers is undertaking supplemental environmental assessment (i.e., additional water quality modelling in early 2014) to confirm the assumptions that the updates to the Project Description will not result in any alteration to the conclusions of the EIS with respect to water quality in the receiving environment during operations and in Kennady Lake at closure.

Many of the potential causes of delays can be mitigated by careful attention to the risks to the regulatory process. The Land Use Permit, Water Licence, and supporting monitoring and management plans include a conformity table that demonstrates that measures, follow-up programs, and developer commitments have been addressed through the management plans and monitoring program.

20.1.3 RESIDUAL RISKS

The water license process and hearings will be regulated by the MVLWB. Although De Beers will take every opportunity to enhance the process by providing timely additional information that is requested and by hosting meetings with various technical experts to resolve technical issues, the responsibility for the schedule and decisions lies with the MVLWB, the federal and GNWT Ministers and their departments.

20.2 Biophysical Environment

The biophysical environment associated with the project includes components such as air quality; the terrestrial environment (i.e., bedrock geology, terrain, soils and permafrost; vegetation; wildlife); and the aquatic environment (i.e., hydrogeology; hydrology; water quality; and fish and fish habitat). This section provides, when relevant, a summary of the following information relating to these components of the biophysical environment:

- the existing biophysical environment
- project-environment interactions and mitigation
- potential residual impacts and regulatory risks.

The baseline biophysical information described below has been collected since 1996. In recent years there has been a concerted effort to obtain information that not only informed the environmental

assessment, but to also provide an appropriate basis for use in the future monitoring programs to identify potential effects, and to evaluate impact predictions and monitor the efficacy of mitigation.

20.2.1 EXISTING ENVIRONMENT SUMMARY

This section provides brief summaries of baseline conditions for each biophysical component. For aquatic components, the summaries are focused on the area immediately surrounding the project, corresponding to the Kennady Lake watershed, and downstream watersheds to Kirk Lake (Figure 20-1). Together, these areas comprise the Local Study Area (LSA). The LSA for terrestrial components is a square of approximately 200 km² centred on the Kennady Lake (Figure 20-2). Summaries provided for wildlife pertain to a larger Regional Study Area (RSA) as necessitated by the home ranges of the species discussed. The wildlife RSA is a square of approximately 5,700 km², centred on the Kennady Lake, corresponding to the area used by caribou during the northern and post-calving migrations in Figure 20-2 below.

Figure 20-1: Aquatic Local Study Area

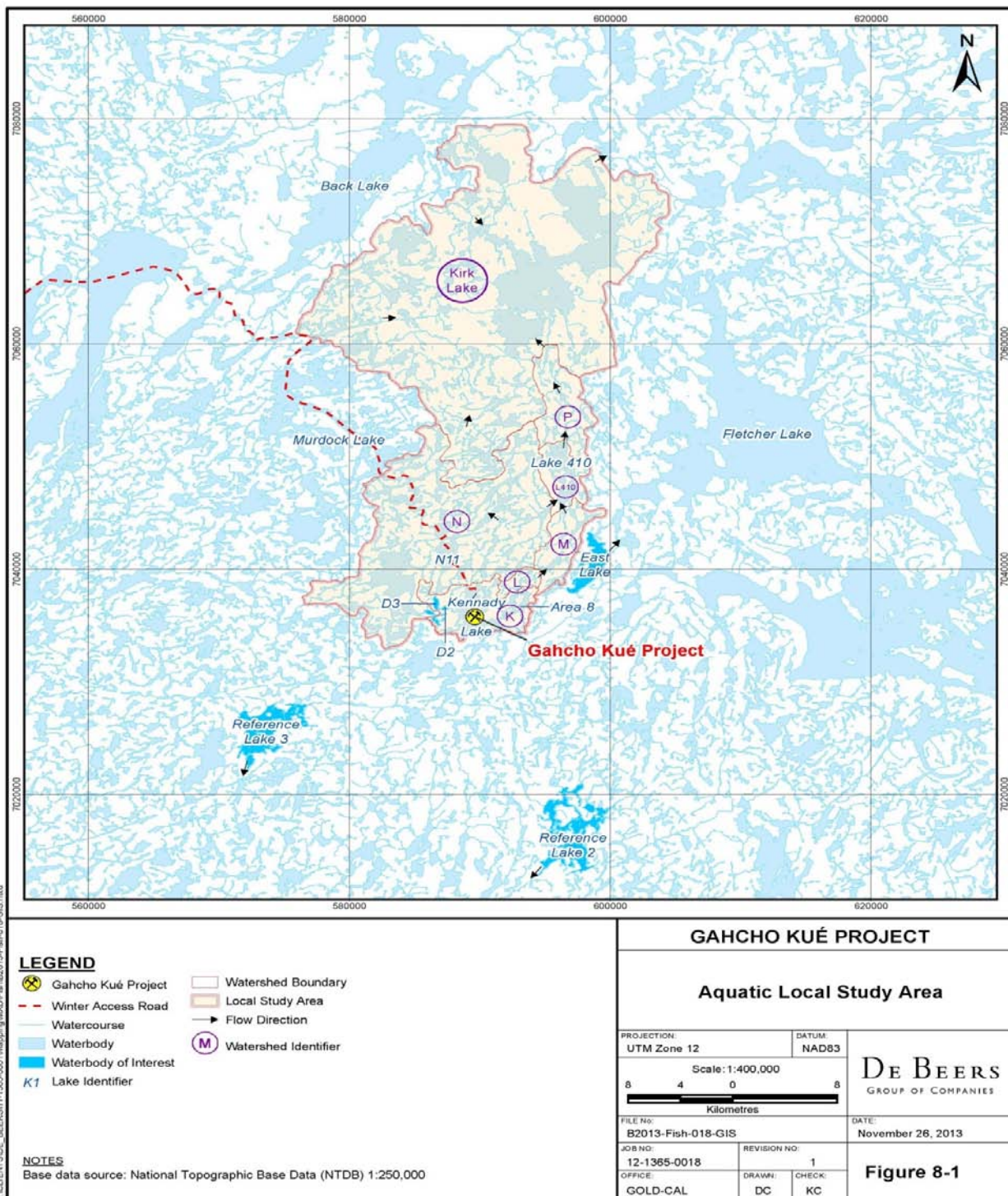
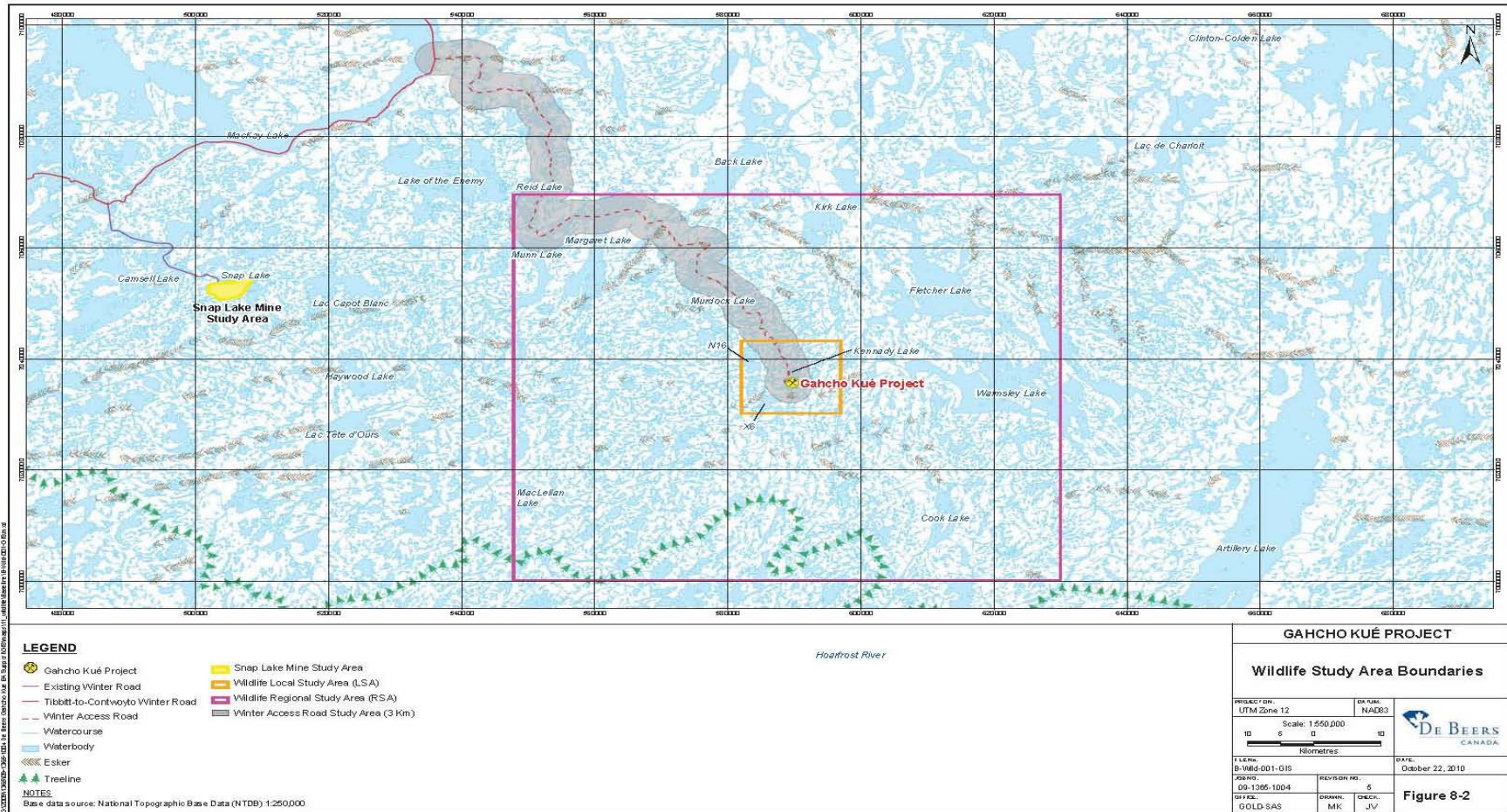

Figure 20-2: Wildlife Study Area Boundaries



20.2.1.1 AIR QUALITY

Meteorology & Climate

Prevailing winds at Yellowknife are from the east, with northwest winds more common in winter and southeast winds more common in summer. Winds at the project are more commonly from the northeast. The most frequent wind speeds vary between 3 and 4 m/s, with few winds over 15 m/s. At the project, maximum gusts in excess of 15 m/s occurred on 28 of 260 days during a recent survey, with the strongest gusts usually coming from the west or north.

Median ambient temperatures at the project range from a low of about -33°C in January to a high of about 14°C in July. Atmospheric stability at the project follows a diurnal cycle with stable conditions occurring during the night and unstable conditions occurring during the day. Unstable conditions occur more frequently during the spring and summer.

It rains most often in September at the project location, with the highest monthly total recorded in August. Based on 2004/2005 data, there was substantial seasonal variability in relative humidity at the project, with median values ranging from 70% in summer to near 90% in fall. In all hours and all months, the maximum relative humidity can be near 100%. Minimum values tend to be highest in winter months and lowest in the summer during the afternoon.

Additional meteorological data were collected in 2011 and 2012. These data are generally consistent with previous data, but have supplemented the baseline database for use in future monitoring programs.

Background Air Quality

Measurements that most accurately represent background concentrations of particulate matter at the project were collected from the research station at Daring Lake between 2002 and 2006, and to a lesser extent at the project. Particulate matter was measured as $\text{PM}_{2.5}$ (particulate matter with particle diameter nominally smaller than $2.5\ \mu\text{m}$) and PM_{10} (particulate matter with particle diameter nominally smaller than $10\ \mu\text{m}$). A representative value for the background $\text{PM}_{2.5}$ concentration at the project location is $1.9\ \mu\text{g}/\text{m}^3$. The PM_{10} concentration that best represents conditions at the project is $3\ \mu\text{g}/\text{m}^3$. The representative background value of total suspended particulates is $7\ \mu\text{g}/\text{m}^3$, based on data collected at Snap Lake.

Estimated background concentrations of gaseous compounds at the project, based on measurements in communities, are $5.7\ \mu\text{g}/\text{m}^3$ for nitrogen dioxide (NO_2), $2.6\ \mu\text{g}/\text{m}^3$ for sulphur dioxide (SO_2) and $3\ \mu\text{g}/\text{m}^3$ for ozone.

20.2.1.2 NOISE

Noise baseline data were collected in July 2004 at two sites selected to represent the ambient conditions within near the project. These sites were situated about 400 and 800 m in different directions from the exploration camp, on areas of different topography, allowing an evaluation of the natural variability of ambient conditions in the region.

The existing noise environment at the surveyed area in July 2004 was characterised by relatively low noise levels, in the range 30 to 32 A-weighted decibels, without tones, during both day and night. This level of existing noise indicates a quiet natural environment, which is expected for undeveloped northern areas.

20.2.1.3 BEDROCK GEOLOGY, TERRAIN, SOILS & PERMAFROST

Bedrock Geology

The project is located in the eastern terrain of the Slave Geological Province, which is characterised by calc-alkaline bimodal volcanic rocks and thick sequences of greywacke and mudstone. The dominant rock types near the project are granite and gneissic granite. The metamorphic grade of the supracrustal rocks ranges from lower to middle greenschist in the northwest to upper amphibolite facies in the south. Metasediments occur along the eastern edge of the LSA. Several sets of Proterozoic mafic dykes occur within the project area. Kimberlite rocks underlie lakes and occur within the southeast Slave kimberlite field in the LSA.

Structural analysis indicates a tight fold to the northeast around an ultramafic intrusive body west of the kimberlite cluster. Immediately surrounding the kimberlite cluster there is a dominant northeast-trending fabric. The kimberlite placement appears to be controlled by discrete primary and secondary brittle structures.

Geological hazards related to seismicity and radioactivity are considered to be low. Hazards are considered to be mainly related to potential for slides and flows of material after thawing of permafrost. The dominantly granite rock in the area is generally competent, and rock falls in areas of rock exposures in relatively steep terrain are likely rare.

Terrain

Terrain features described in the LSA include surficial geology, landform, permafrost, relief, elevation, drainage, and material modifying processes. The dominant deposit types in the LSA are bedrock (granite), morainal (till mainly less than 1 m thick), glaciofluvial (including eskers), and organic (bog peat and fen peat). Water-laid (fluvial) and aeolian sediments are of minor occurrence in the LSA. Four upland landform types were recognised within the LSA area, including undulating to hummocky, undulating, ridged, and inclined. Peatland forms included polygonal peat plateau bog, peat plateau bog, lowland polygon bog and fen and horizontal fen.

The terrain map of the LSA is based on the combination of the type of surficial material and the landform. Most of the terrain map units consist of complexes of one type of terrain with another type or types. Approximately 30% of the LSA is occupied by lakes and ponds, 54% is accounted for by complexes where morainal landforms dominate, 15% is dominated by bogs and bog complexes, and eskers comprise 0.3%. Other terrain types occur as substantial to minor inclusions in other units. The main types are bedrock outcrops, which commonly occur within morainal terrain, and fluvial channels, which link the numerous waterbodies in the area.

Permafrost features are common throughout the LSA. Piping, “boiling,” and heaving of the active layer, thermokarst and thermo-erosion, and pingo development are of primary importance.

Soils

Eight soil associations were identified in the LSA, each generally corresponding to an ecological land classification vegetation type. Three of the associations are developed on non-calcareous, moderately coarse to coarse-textured till deposits: Blob Lake (Turbic Cryosol, till greater than 1 m reworked by permafrost processes); Lobster Lake (Dystric Brunisol, till greater than 1 m); and Wolverine Lake (Dystric Brunisol, till less than 1 m over bedrock). Two of the associations are characterised by Organic Cryosol soils, but are differentiated based on the nature of the peat. These are referred to as the Dragon Lake (fen peat) and Sled Lake (bog peat) associations. The Goodspeed Lake Association includes shallow Organic and alluvial soils along drainage ways. The Hoarfrost River Association occurs on glaciofluvial deposits, mainly eskers, and mainly consists of Regosol soils.

Map units where the Wolverine Association is dominant account for 54% of the LSA, map units dominated by the Sled Lake Association account for 14.5% of the LSA, open waterbodies account for 29.9% of the LSA, and the other units account for less than 1% of the LSA.

Soil chemistry data show that the surface organic layers (LFH horizons) of mineral soils and the surface peat layers of Organic and Organic Cryosol soils are extremely acidic, with pH values generally less than 4.6. Mineral soils fall into very strongly acidic (i.e., pH 4.6 to 5.0), strongly acidic (i.e., pH 5.1 to 5.5), and medium acidic (i.e., pH 5.6 to 6.0) categories. The total element concentrations vary widely between sites but are lower than the maximum allowable concentrations for soil in the Canadian Environmental Quality Guidelines.

Sixty-four percent of the LSA, which represents almost all of the non-water area, has a low rating in terms of water erosion, although some areas of medium and high susceptibility occur. Fifty-seven percent of the LSA is rated as having medium susceptibility to wind erosion. Most of the upland soils are coarse textured and non-cohesive, and would be readily moved by wind, as would the lowland soils of bogs and fens, under disturbed conditions.

All soils in the LSA were categorised as being sensitive or of moderate sensitivity to acidification. The sensitive class pertains mainly to upland soils, especially the Wolverine Association, which is characterised by low acid buffering capacity due to low clay content and low CEC capacity. Organic and Organic Cryosol soils were categorised as moderately sensitive.

Additional soil surveys were undertaken in close proximity to the project site in 2013. This work has built upon the previous baseline understanding through monitoring of physical and chemical soil characteristics, and specific soil microclimate (soil moisture and temperature) detail. This work was undertaken to inform the Vegetation and Soils Monitoring Program as part of the Land Use Permit requirements.

Permafrost

The project is located near the southern limit of continuous permafrost. Permafrost extends over approximately 90% to 95% of the surrounding area. Depth of permafrost varied from 120 to 310 m among three boreholes near the project. The minimum mean annual permafrost temperature in the project area was estimated to be -3.5°C. The likelihood of observing this temperature is expected to be highest in well-drained peat bogs and peat veneers, and the tops of eskers and bedrock outcrops. Positive mean annual soil temperatures (up to 1.5°C) may be encountered within tall shrub habitats and at lake banks.

The predicted depth of the active layer varies among terrain types, ranging from 0.4 to 4.0 m. Organic veneers and peat bogs with high soil moisture content and dry/moist sphagnum are estimated to have the shallowest active layer (0.4 to 0.9 m). In contrast, eskers and bedrock that have little vegetation cover and low moisture content are predicted to have the thickest active layer (3.0 to 4.0 m).

Based on field surveys, mineral soils in the vicinity of the project contain low ice content. In contrast, glaciofluvial deposits have higher ice content, and organic deposits, such as peat bogs, are ice rich. Other earth and permafrost processes observed in the area included piping (which produces stone channels), mud boil and heaving of the active layer, ice wedges, thermokarst and thermo-erosion. Three pingos were identified in the area surrounding the project.

20.2.1.4 VEGETATION

During ecological land classification mapping in the 19,500 ha of the LSA, 1,327 polygons were identified. Thirteen vegetated ecosystem types, two sparsely vegetated ecosystem types, two anthropogenic ecosystem types, and three open water conditions were identified. The dominant ecosystem types are Scrub Birch – Labrador Tea Tundra and Scrub Birch – Cloudberry Low Shrub Bog.

Rare plant surveys conducted in 2004 and 2005 in the LSA documented no rare plants. Species richness and evenness, and landscape-level diversity are variable within the LSA.

The landscape diversity metrics calculated for the LSA indicate that landscape-level diversity is moderate. Baseline data on metal concentrations in plant tissues and soil samples are available for comparisons with future monitoring data.

Additional vegetation surveys were undertaken in close proximity to the project site in 2013. This work has built upon the previous baseline understanding through monitoring of focussed plant species composition, vigour and health, as well as dust deposition studies. This work was undertaken to inform the Vegetation and Soils Monitoring Program as part of the Land Use Permit requirements.

20.2.1.5 WILDLIFE

Caribou

Barren-ground caribou have a significant social, cultural, and economic value for the people and communities living in the Canadian Arctic. Caribou are a keystone species because they influence the

landscape through their movements and feeding, and provide food for predators and scavengers such as wolves, grizzly bears, wolverines, and foxes. Caribou populations with ranges that potentially overlap with the RSA are the Bathurst, Ahiak (Queen Maud), and the Beverly herds.

Caribou generally first appear near the project in late-April and early-May. From 1999 to 2005, 100 to over 3,000 caribou were observed in the RSA during the northern migration, with the exception of 2002 when nine caribou were observed. Satellite-collar data suggest that caribou observed in the RSA during the northern migration were likely from the Bathurst and Ahiak herds.

Surveys completed at the start of the northern migration (late-April to early-May) in 2004 and 2005, documented 42% and 29%, respectively, of the caribou groups foraging and resting, while the remaining groups were observed walking. The proportion of caribou groups observed foraging and resting near the end of the northern migration (mid-to-late May) was 13% and 38% in 2004 and 2005, respectively. The remaining 87% and 62% of the caribou groups were walking in 2004 and 2005, respectively.

The project is not located near the calving grounds for the Bathurst, Beverly, or Ahiak caribou herds and no observations of caribou were reported in the RSA during this time. Although, few caribou were observed in the RSA during the post-calving period, no satellite-collared caribou from the Bathurst, Beverly, and Ahiak herds were recorded in the RSA from 1995 to 2007.

Caribou were observed within the RSA during the summer dispersal period; however, the number of caribou present within the RSA during the summer of any given year varied greatly (ranged from 104 to 30,000). The largest of these groups was estimated at 30,000 caribou in 1999. Satellite-collar data suggests that caribou observed in the RSA during the summer dispersal were likely from the Bathurst herd.

Although surveys completed in the summer of 2003 found few caribou in the RSA (104 individuals), the results suggest that there is high likelihood of caribou occurring in the RSA during the summer dispersal period.

The timing of fall movements towards wintering grounds also varied among years; however, surveys completed from 1999 to 2005 indicated that caribou were usually present in the RSA in late September or early October. Large aggregations of caribou were observed in the RSA in 1999, 2000, and 2005, which corresponds to the satellite-collared caribou data recorded for the RSA. Satellite data indicated that no caribou from the Beverly or Ahiak herds were present within the RSA during the fall migration; however, collared individuals from the Bathurst herd were recorded in several years. Less than 1,000 caribou were estimated in the RSA during the fall migration from 2001 to 2004. Few caribou were counted along the winter access road in 2004 and 2005.

Eleven percent of the caribou groups observed within the RSA in 2004 had calves. In 2005, very few calves were observed within the RSA, and the proportion of caribou groups with calves was about 4%.

Fall movement towards the wintering grounds was not evident in 2004 and 2005, as most animals were observed foraging and resting. In 2004, 37% of the caribou groups were observed walking, while 50% were foraging and resting. Evidence of rutting activity was not observed. In 2005, 22% of the 86 caribou groups were walking, while 78% were foraging and resting. Track evidence suggested that animals had not reached the southwest corner of the RSA. Rutting activity was evident during the 2005 survey.

Although aerial surveys were not completed during the winter dispersal period, satellite-collared caribou data indicate that, over the years, caribou from the Beverly (2006), Bathurst (1996, 2003, 2005, and 2006), and Ahiak (2002, 2006, and 2007) herds were present in the RSA. In addition, observations from wildlife log books recorded caribou in the LSA during the winter. Snow track surveys completed in late winter 2004 also provided evidence of caribou feeding and foraging in the LSA.

Habitat selection and caribou behaviour are frequently the result of their response to environmental conditions, and appears to be related to food availability, ease of travel, relief from insects, and predation. Analysis indicated that caribou were found more frequently than expected on frozen lakes during the northern migration, which were used for travel through the RSA. During summer, caribou used peat bog, heath tundra, and tussock-hummock habitats more often. In the fall, caribou selected heath tundra, sedge wetlands, and tussock-hummock habitats relative to their availability.

Caribou surveys were also undertaken in 2012 to 2013. In addition, De Beers provided funding to the GNWT for regional caribou monitoring and programs. There has been a series of workshops hosted by the GNWT in 2013 to develop a cumulative effects monitoring framework.

Barren-Ground Grizzly Bear

Barren-ground grizzly bears have the largest home ranges and likely the lowest population density of brown bears studied in North America. Based on the GPS-collared grizzly bear data (McLoughlin et al. 1999), two (2) grizzly bears maintained home ranges and den sites close to the RSA. Based on density estimates of 3.5 bears per 1,000 km² (McLoughlin and Messier 2001), up to 20 individual bears may inhabit portions of the RSA.

Grizzly bears and bear sign have been documented in the RSA from 1999 through 2005. Although no bears were observed within the RSA in 1998 or 1999, three sets of grizzly bear tracks were identified in 1999. In 2004, eight different grizzly bears (five adults and three cubs) were observed within the RSA and a minimum of six different grizzly bears were present in 2005. In the RSA, most sightings occurred during the spring, with observations decreasing during the late summer and fall.

The number of bear signs per plot in the RSA, calculated from habitat surveys completed in 2005 and 2007, was slightly lower in riparian habitats (0.80 and 0.77) compared to wetlands plots (1.07). In 2005, the occurrence of grizzly bear sign in sedge wetlands plots ranged from 23% to 60% and from 12% to 46% in riparian plots in the RSA. In 2007, the proportion of riparian plots with sign increased to 31% to 69%. Annual variation was evident in riparian habitats, as the proportion of plots with fresh sign was higher in 2007 than in 2005.

Surveys for grizzly bear sign along eskers completed in the RSA in 1999 located 14 grizzly bear den sites (13 inactive and one active) on eskers, while the majority of the 24 den sites (19 inactive; three active, and two test dens) recorded during the 2004 and 2005 surveys were located adjacent to an esker. Of the four active dens recorded since 1999, one was located in heath tundra, one in tussock-hummock, one in heath-boulder, and one adjacent to the esker. The test den identified in 2004 was located in tussock-hummock, while the test den located in 2005 was found in a small glaciofluvial deposit located adjacent to a lake. Esker use surveys completed in the RSA in 2007, documented 59 observations of grizzly bear sign on eskers, resulting in 0.76 sign per km surveyed. De Beers funded a regional grizzly bear monitoring program in 2013 to contribute to the regional understanding of grizzly bear populations. This program will continue into 2014. The program is consistent with methods used by other diamond industry monitoring programs and the results after two years of monitoring will be compiled by the University of Calgary in partnership with the GNWT ENR.

Wolf

The abundance of wolves within the RSA is expected to vary annually and seasonally in response to factors such as prey availability and suitability of den habitat. Wolves occur seasonally in the RSA from March through October, coinciding with the caribou movements through the region. A total of 46 wolves and 9 pups were recorded from 1999 to 2007.

Within the LSA, relative activity levels were determined from track count surveys completed in the late winter of 2004 and 2005. In 2004 and 2005, wolf track densities in the LSA were 0.07 and 0.05 tracks per kilometre per day (TKD), respectively. Wolf sign surveys completed in 2007 on eskers within 35 km the project recorded a total of 34 observations on eskers, resulting in 0.44 sign per kilometre surveyed.

Wolf dens located in the RSA during baseline surveys were established on eskers or other glaciofluvial deposits such as kames. Dens associated with eskers were often on terraces, side deposits, or esker ends rather than on the top of the esker. Since 1999, nine active wolf dens were identified in the RSA, some of which were used in consecutive years. Active wolf den sites within the RSA ranged from 6 to 37 km from the project. De Beers provided funding to the GNWT in 2012 to undertake regional wolf pup monitoring. This program was initiated by GNWT ENR, in part, to understand the potential pressure of wolves of caribou populations.

Fox

The Arctic and red fox are the most abundant carnivores in the Arctic tundra. Observations of fox and fox sign have been documented in the RSA since 1998. Although fox sign was observed in 1998, foxes were not sighted. During the course of these surveys, no Arctic fox were observed within the RSA, as the study area is within the southern-most part of the species' home range. Red fox, in contrast, were relatively common year-round residents within the RSA. In 2004 and 2005, red fox were observed regularly near the project camp, and one was thought to be living near the storage buildings.

Track count surveys completed within the LSA in May 2004 recorded 114 fox tracks. Track density was calculated to be 0.13 TKD. In March 2005, 68 fox tracks were recorded for a density of 0.14 TKD. One

red fox was observed. All transects were surveyed in April 2005 and 41 tracks were recorded for a density of 0.11 TKD. Because historical tracking data in the region is not available, it is not possible to compare these results to other baseline studies.

Since 1999, 24 active fox dens were identified in the RSA. Dens were established on eskers or other glaciofluvial deposits such as kames, and ranged from 2 to 38 km from the project.

Wolverine

From 1998 through 2005, 27 wolverines were documented in the RSA. Wolverine activity and frequency of sightings coincided with the major spring and fall caribou migrations. Habitat within the RSA appears to provide adequate availability of potential den locations. Since 1999, four wolverine dens were located within the RSA, ranging from 7 to 15 km from the project camp. Track count surveys completed in May 2004, recorded 73 wolverine tracks over 237 km. Standardised (normalised for days since last snowfall) track density was 0.08 wolverine TKD. In March 2005, wind and snow resulted in only seven wolverine track observations over 195 km. Wolverine track density in 2005 was 0.01 and 0.12 TKD for March and April, respectively.

In 2004, fewer tracks were located near the project than in 2005 suggesting an annual change in distribution around the project.

Wolverine DNA hair snagging studies were completed near the project in 2005 and 2006 within a 1,600 km² sampling area that covered the LSA and part of the RSA. In 2005, nine female and eight male wolverines were identified. Results from 2006 detected 17 individuals (11 females, six males). Population estimates for the project suggest that the number of wolverine in the region of the Gahcho Kué Project is lower than in the Lac de Gras region.

De Beers undertook additional wolverine regional monitoring in 2013, as agreed to during the EIR process. This information, similar to grizzly bear, will be used to gain a better understand of regional wolverine populations. The GNWT will be analyzing the data from this as well as from other diamond mines monitoring to compile a report on the status of wolverines in the NWT.

Muskoxen

From 1995 to 2003, eight observations of muskoxen were recorded within the RSA during aerial surveys completed for caribou. Group size ranged from 2 to 47 individuals from 1995 to 2003. In 2004 and 2005, muskoxen appeared to be relatively common (15 observations total) and were observed within the RSA during all aerial surveys. Group size ranged from three to 92 individuals in 2004 and 2005. The higher number of muskoxen observed in 2004 and 2005 may be the result of the increased survey effort in these years or may reflect potential immigration or movement into the RSA. Esker surveys completed in the RSA in 2007 estimated muskoxen sign at 0.14 sign per kilometre surveyed.

Moose

Traditional moose range encompassed suitable habitat south of the treeline throughout the NWT. Traditional knowledge indicates that moose are not common to the RSA, although moose have occasionally been observed. From 1996 through 2005, 14 moose were recorded within the RSA.

Upland Breeding Birds

A total of 28 species of songbirds, shorebirds, and ptarmigan were detected within survey plots in the RSA. Lapland longspurs were the most common birds observed in heath tundra and sedge wetlands, while savannah sparrows, Harris' sparrows, and American tree sparrows were also abundant. The highest individual species densities observed in the RSA were Lapland longspur in sedge wetlands and savannah sparrows in sedge wetlands. Sedge wetlands had more shorebird species than other habitats, including four species only detected in wetlands: pectoral sandpiper, short-billed dowitcher, semi-palmated sandpiper, and white-rumped sandpiper. One shorebird species, the semi-palmated plover, was detected in the heath tundra.

Mean relative abundance (birds per plot) and observed richness (species per plot) were higher in sedge wetlands. Overall, the abundance of birds per plot ranged from 24 to 173, and the number of species per plot ranged from five to 17. Species richness was significantly higher in wetlands where 25 species were detected, as compared to heath tundra plots where 21 species were observed. Diversity indices suggest that sedge wetlands may be richer in species, but the number of birds of each species (i.e., evenness) was less evenly distributed than in heath tundra habitats.

Additional bird and water bird surveys were undertaken in 2013. There are also plans to undertaking monitoring in 2014 to develop a detailed mitigation strategy to reduce potential impacts on nesting and migratory birds during the dewatering phases of the project.

Waterbirds

Waterbird observations have been recorded within the RSA since 1998. Over 7,200 waterbirds were recorded in 2004 during an intensive survey, with 6,900 documented during the spring migration. Between 1998 and 2005, 22 waterbird species were documented in the RSA. The most common waterbird species recorded were snow geese, greater white-fronted geese, and Canada geese. Traditional knowledge holders from Łutsel K'e Dene First Nation identified 35 bird species that are known to inhabit the project area.

Greater white-fronted and Canada geese potentially breed within the RSA, while snow geese are considered migrants and travel further north to breed. Of the 12 duck species recorded within the RSA, all are expected breeders within the RSA, with the exception of the black scoter. The yellow-billed, Pacific, and red-throated loons are also known to breed throughout the RSA, whereas common loons are presumed to be breeding within the southern, forested area of the RSA.

Raptors

Raptors are birds of prey and include falcons, eagles, hawks and owls. Consistent with raptor studies in the Arctic, cliffs were the main feature of raptor habitat in the RSA. In general, the topography within the RSA can be described as gentle undulating terrain; therefore, quality raptor nesting habitat is limited.

Since 1996, ten raptor species and ravens were recorded within the RSA. In 1996, and from 1998 to 2005 (excluding 2004), 97 incidental raptor observations were recorded, and the most frequently observed species were the common raven, followed by the peregrine falcon, and bald eagle. In 2004, an intensive aerial survey of all suitable raptor nesting habitat within the RSA was completed. Of the 94 raptor observations recorded in 2004, the most common species observed within the RSA were peregrine falcon, northern harrier, common raven, rough-legged hawk, gyrfalcon, and bald eagle. Only a limited number of sightings of short-eared owls, golden eagles, northern hawk owls, snowy owls, and merlins were documented in the RSA.

Ten active raptor nests, including 22 nestbound chicks, and 17 unoccupied nests were observed in 2004 and 2005. Of the 27 raptor nests identified within the RSA, 15 were falcon nests, including four gyrfalcon and 11 peregrine falcon nests. A total of 22 chicks were identified in the RSA from 2004 to 2005, including eight peregrine falcon, five gyrfalcon, and nine raven chicks.

20.2.1.6 HYDROGEOLOGY

Geological Framework

The project kimberlites lie in the southeastern portion of the Slave Province. The local bedrock geology is dominated by granite and gneissic granite. Metasediments are mapped along the eastern edge of the Kennady Lake area, and an ultramafic intrusion is identified to the west of the kimberlite cluster. Faults mapped from geophysical data and confirmed through geotechnical drilling investigations, appear to have controlled the emplacement of the kimberlites.

Glacial deposits are related to the Late Wisconsin glaciation and consist mainly of glaciofluvial reworked till, eskers and glaciofluvial deposits. Lake bottom sediments at the base of Kennady Lake have an average thickness of 7 m. Till in upland areas has a thickness that is typically 0 to 2 m. The lake bottom sediments are described as containing sand, pebbles, cobbles, boulders, and few fines. The lake bottom sediments are overlain by a thin organic mat, and the on-land till may be overlain with peat up to several metres thick.

Permafrost thickness in the project area was determined to be 295 m beneath land and between 100 and 125 m thick beneath islands within Kennady Lake. Lakes with areas of 1 km² or larger, including Kennady Lake, are expected to have open taliks underneath. Smaller lakes may have closed taliks that do not fully penetrate the permafrost thickness.

Hydrogeology

In the area of the project, near-surface groundwater flow is seasonal and restricted to the active layer, which is up to 4 m thick depending on the nature of the surface materials. Shallow groundwater is underlain by impermeable permafrost, isolating it from deeper sub-permafrost groundwater. Seasonal melting of the active layer and precipitation provide recharge to the shallow groundwater system. Groundwater flow follows the topographic gradient towards the nearest surface waterbody, and it is estimated to be in the range of centimetres per day.

Groundwater flow within the deeper flow system is restricted to the sub-permafrost zone and to fully penetrating taliks. Lakes with fully penetrating taliks are hydraulically connected to sub-permafrost groundwater, and the elevations of these lakes are expected to control the hydraulic head distribution within the deeper groundwater system. Lake elevations within the project area indicate a general easterly direction of deep groundwater flow with a northeastern and southern component.

Field investigations have defined bedrock units with different hydraulic characteristics, as follows: exfoliated bedrock, kimberlite, kimberlite-bedrock contact and bedrock. The exfoliated bedrock and kimberlite units were subdivided further by depth as hydraulic conductivity was found to decrease with depth in these units. Hydraulic conductivities for each unit are generally low.

Groundwater Quality

Groundwater is dilute in the shallow (active) zone and in the unconsolidated deposits. Saline groundwater was measured at various locations with depth. Groundwater pressure data imply higher salinity than was measured. Calcium, chloride, and sodium are generally the dominant ions. Groundwater proximal to the kimberlitic pipes within the contact zones appears to be more mineralised than groundwater sampled farther away within the outlying rock. This observation is unexpected given the higher relative conductivity of this zone. In addition, increases in salinity may be more pronounced at the site than that represented by the regional relation reported in the literature.

An additional groundwater quality program was undertaken in 2011. This work generated supplemental groundwater quality data for the Westbay bores located in the project area at various depths through the groundwater regime (to 400 m depth) to that collected in 2004 and 2005. This work showed that groundwater quality (i.e., TDS) does increase with depth, and that groundwater inflows below 200 m may reach approximately 10,000 mg/L.

20.2.1.7 HYDROLOGY

The project is located in a sub-Arctic climate, characterised by long, cold winters and short, cool summers. Temperatures typically fall to below freezing by early October and remain so until mid- to late May. Monthly mean temperatures persist below -20°C from December through March, with daily means occasionally reaching below -40°C. The warmest month is July with a mean temperature of about 12°C. Measured mean annual precipitation in the region is approximately 270 mm with about half falling as snow during the October to May winter period. Estimated annual mean lake evaporation

is 285 mm based on local and regional data and annual mean evapotranspiration is estimated at 66.8 mm based on a site water balance.

The project is located in the watershed of Kennady Lake, a small headwater lake within the Lockhart River system. Within the Kennady Lake watershed, lakes generally comprise more than 35% of the landscape. Kennady Lake receives runoff from smaller tributary watersheds, each of which typically contains a series of small lakes with interconnecting channels, through which tributary runoff is conveyed before it reaches Kennady Lake. The mean annual discharge at the outlet of Kennady Lake is many times greater than that at any of its tributaries.

Lake levels in the LSA follow a predictable seasonal cycle, with a very rapid spring rise, which appears to occur before there is any loss of ice cover and before the onset of discharge at the lake outlet. Lake water level typically peaks shortly after the onset of discharge, especially for smaller lakes.

The lowest water levels of the season typically occur during the second half of August. From late August into September, water levels typically increase, due to an increase in rainfall during late summer and early fall.

During winter, ice thicknesses in lakes appear relatively consistent, with average values of about 1.7 to 1.8 m based on data collected in 2004 and 2005. All lake outlets that were examined during baseline studies were completely frozen with zero flow during the winter. This appears to be the typical winter condition for all lakes in the Kennady Lake watershed and small lakes downstream of Kennady Lake.

The drainage direction from Kennady Lake is northward, and passes in sequence through L watershed, M watershed, Lake 410, P watershed (i.e., the downstream extent of the LSA), and finally Kirk Lake. The drainage from Kirk Lake passes through Q watershed before entering Aylmer Lake. At Lake 410, drainage from Kennady Lake meets flow from the adjacent N watershed.

Additional hydrometric and meteorological studies, including channel and shoreline assessments, in the local study area, were undertaken in 2011, 2012, and 2013. This work supplemented the baseline information for winter snow pack ranges, water levels and flows, and added bathymetric details, for water bodies downstream of Kennady Lake, and in the adjacent N lakes.

20.2.1.8 WATER QUALITY

Kennady Lake and other lakes in the LSA are typical sub-Arctic tundra lakes with ice cover during seven to eight months of the year and a short open-water period (four to five months), occurring typically from early June to October.

Kennady Lake is inversely stratified during under-ice conditions and predominantly well mixed during open-water conditions. These features were consistent with other lakes sampled in the LSA, for example, Lake 410 and Lake N16. Seasonal thermocline development can occur in deeper parts of Kennady Lake during open-water conditions. The near-bottom layers in deeper lake basins are prone to dissolved oxygen depletion during winter. Some shallower lakes in the Kennady Lake watershed and

shallow basins of Kennady Lake remain well mixed throughout open-water conditions and are not prone to oxygen depletion during late winter.

Baseline water quality data collected in the LSA between 1995 and 2005 showed that water quality was similar between basins of Kennady Lake and other lakes in the LSA and seasonal variability was minor. Most lakes can be classified as having low concentrations of total dissolved solids, alkalinity and hardness. These lakes are oligotrophic due to low levels of mineralization and nutrients. Thus, these lakes are expected to have relatively low biological productivity. In general, these lakes are highly sensitive to acidification, which is common on the Canadian Shield and in sub-arctic tundra. Metal concentrations were relatively low within most lakes. Aluminum, copper, and iron were most common metals with concentrations above aquatic life water quality guidelines.

Other metals with occasional concentrations above guidelines included chromium, manganese, silver, selenium and zinc. Given the general lack of development in the area, guideline exceedances are thought to result from natural processes.

Bottom sediments in Lake 410 had significantly higher organic content and total petroleum hydrocarbons compared to Kennady Lake and Lake N16, while Kirk Lake exhibited the highest concentration of inorganic carbon. Concentrations of most metals in Lake 410 were consistent with those observed in Kennady Lake and Lake N16. Most sediment samples collected from lakes in the LSA were non-toxic to laboratory test organisms, although occasional reductions of survival and growth of *Hyalella azteca* were observed in Kennady Lake sediments (basins K1, K2, K4) collected in 2004, but not in 2005 samples collected in Kirk Lake and Lake N16. Conversely, no reductions of survival or growth of *Chironomus tentans* were observed in 2004, but *Chironomus* growth was reduced in Lake N16 sediments collected in 2005.

Additional water quality and sediment quality surveys were undertaken in 2011, 2012, and 2013. This work supported the findings of previous studies, but improved the level of understanding of water and sediment quality in the waterbodies within the local study area (especially, the N lakes, Lake 410, and Kirk Lake, which did not have a large dataset throughout the environmental assessment). Of some note, monitoring was modified to better understand the intra-lake variability and to include a series of reference lakes to advance the status of baseline information for applicability to Aquatic Effects Monitoring Program requirements. The program provides some understanding of the speed of transition in physical limnological parameters (e.g., DO, pH, conductivity, temperature) between late winter and spring freshet.

20.2.1.9 FISH & FISH HABITAT

Aquatic Habitat

Aquatic habitat in Kennady Lake includes a nearshore zone and a deep-water offshore zone roughly separated by the 4 m depth contour. Most (88%) nearshore habitat in Kennady Lake has a shallow gradient (less than 10°). Shorelines are dominated by boulder and cobble substrates (47% of all nearshore habitats), which become more embedded with finer sediments with increasing depth.

Nearshore habitats less than 2 m deep are ice-scoured each winter and are typically unavailable for fall spawning species such as lake trout and round whitefish. Aquatic vegetation in Kennady Lake is very limited, occurring mostly at tributary mouths and in rare shoreline areas where fine substrates accumulate. Substrates in the deep-water zone are typically comprised of a thick layer of fine sediments. Kennady Lake does not contain any offshore shoals and all shallow-water habitats are associated with the shoreline.

Kennady Lake is naturally drained at its eastern end through a series of streams and small lakes. Streams downstream of Kennady Lake generally have a low gradient and are comprised of braided channels with low banks and large angular boulder substrates. In spring, these streams provide spawning habitat for Arctic grayling residing in Kennady Lake and in downstream lakes. Flows are much reduced in summer and movement of large-bodied fish in many of these streams is restricted by exposed boulders. Streams immediately north of Kennady Lake in the adjacent N watershed (streams N6 to N2) have similar habitat to those of the natural outlet. Gravel substrates are rare but do exist in small patches in some streams.

Kennady Lake is surrounded by numerous small and shallow lakes that generally freeze to the bottom each winter. Most of these lakes drain into Kennady Lake through small, low gradient, ephemeral streams. As a result, fish habitat in most Kennady Lake tributaries and access to habitat in upstream lakes decreases substantially in summer and fall. Most small lakes within the Kennady Lake watershed are not fish-bearing. A few larger tributaries with sustained summer flows exist, and provide some spawning and rearing habitat for Arctic grayling as well as access to spawning and rearing habitat for northern pike in several upstream lakes. Three lakes in the Kennady Lake watershed (lakes I1, A1, and A3) are deeper than 7 m and appear to provide year-round habitat for a limited number of fish.

Lower Trophic & Plankton Communities

Kennady Lake has chlorophyll a concentrations, and phytoplankton and zooplankton communities typical of an oligotrophic sub-Arctic lake. During recent surveys, algal abundance and biomass were low and the three dominant algal taxa, which include Chlorophyta (green algae), Chrysophyta (golden-brown algae), and Chrysophyta (diatoms), are typical of northern shield lakes at this latitude. Phytoplankton communities were similar in Kennady Lake, Lake N16 and two (2) downstream lakes (Lake 410 and Kirk Lake). In general, phytoplankton communities were diverse in terms of numbers of taxa present. This is common in oligotrophic lakes where slower growth rates generally permit a greater number of species with a high degree of niche overlap to coexist than would be found in more eutrophic waters.

The composition of zooplankton communities in Kennady Lake, Lake N16, Lake 410 and Kirk Lake was similar; the communities were dominated by calanoid copepods. Rotifera accounted for a substantial portion of the zooplankton abundance, but not biomass. Variability in mean abundance and biomass was high in all waterbodies surveyed.

Benthic invertebrate densities in Kennady Lake were generally low in both August and September in 2004. Shallow littoral areas appear to support a denser and more diverse benthic invertebrate community than deeper mid-lake areas. Dominant taxa in Kennady Lake include aquatic worms (Naididae), fingernail clams (Pisidiidae), and midges (Chironomidae). The benthic invertebrate community of Lake N16 was similar to the community of Kennady Lake. Benthic invertebrate communities at shallow sites in Lake 410 and Kirk Lake were more abundant and diverse than deep sites in Kennady Lake and Lake N16. Comparison of the benthic community of Lake 410 with communities in Kennady Lake and the Lake N16 revealed that lake benthic communities are generally similar within the LSA.

Benthic invertebrate communities in streams were dominated by hydras (*Hydra* sp.), mites (Hydracarina), and larvae of midges and blackflies (Simuliidae), based on summer 2005 samples. Stream benthic communities were characterised by low to moderate density and richness, moderate diversity and low evenness. The benthic component of stream drift samples collected in summer 2005 in streams N3 and L3 was dominated by hydras, but mites and midges were also common. The planktonic component of the drift was dominated by water fleas, likely originating from upstream lakes.

Ongoing lower trophic and plankton sampling through 2011, 2012, and 2013 has informed the baseline understanding in the waterbodies within the Kennady Lake watershed, and immediately downstream of Kennady Lake, and the adjacent N lakes. Similar to water quality, monitoring was modified to better understand the intra-lake variability of these components and included reference lakes to advance the status of baseline information for applicability to Aquatic Effects Monitoring Program requirements.

Fish

Eight species of fish are known to reside in Kennady Lake. By far the most abundant species is round whitefish (*Prosopium cylindraceum*), which comprised more than 50% of the total large-bodied fish community. Lake Trout (*Salvelinus namaycush*) was the second most abundant species and is the top predator in the Lake. Population estimates conducted in 2004 indicated that there was a 95% probability that the Lake Trout population in Kennady Lake was greater than 2,300 fish. Lake Chub (*Couesius plumbeus*) were the most abundant forage fish species. Arctic Grayling (*Thymallus arcticus*) were also present, while small populations of Northern Pike (*Esox lucius*) and Burbot (*Lota lota*) also existed. Ninespine Stickleback (*Pungitius pungitius*) and Slimy Sculpin (*Cottus cognatus*) were forage fish species found generally in littoral areas of the lake.

The fish community of Lake N16 was generally similar to that found in Kennady Lake. Round Whitefish was the most abundant species, and Lake Trout was the most abundant predator. Unlike Kennady Lake, however, Lake N16 had a population of Lake Cisco (*Coregonus artedii*), Longnose Sucker (*Catostomus catostomus*) and White Sucker (*Catostomus commersoni*). Lake Cisco were also found in Lake 410 and Lake M4 downstream of Kennady Lake.

Additional fish and fish habitat surveys were undertaken in 2011, 2012, and 2013. This work included a reference lakes program.

Arctic Grayling and northern pike are the only species to make extensive spawning migrations into streams in spring. Most Arctic Grayling move through the Kennady Lake outlet in spring to spawn in the small lake outlet streams downstream. Arctic grayling from lakes downstream of Kennady Lake are known to migrate upstream to spawn in streams between Kennady Lake and Lake 410. Arctic Grayling also make extensive use of streams immediately north of Kennady Lake in the adjacent N watershed (streams N6 to N2) for spawning. Young-of-the-year Arctic Grayling rear in streams in summer, moving to overwintering habitat in lakes by late-August/early-September.

Northern Pike also move out of Kennady Lake in spring, likely to spawn in flooded riparian and weedy areas in downstream lakes. However, most Northern Pike in Kennady Lake move upstream into the series of small lakes on the western side of Kennady Lake where aquatic vegetation is more abundant. These small lakes (D lakes) likely provide most of the annual recruitment to the Northern Pike population of Kennady Lake.

Supplemental surveys of the watercourses between Area 8 and Lake 410 have been undertaken in 2012 and 2013 to evaluate fish passage accessibility through the open water season to inform the potential barriers to access with respect to flow condition. This information has been utilised to develop, and support, the Downstream Flow Mitigation Plan, which was submitted to DFO in 2012.

Radio telemetry results indicate that lake trout and Arctic Grayling move throughout Kennady Lake during the open-water season but appear to use basin K5 less extensively than other basins in the lake. In contrast, Northern Pike make only small, localised movements and generally remain in one or two basins throughout the year. Insufficient numbers of Round Whitefish were successfully released to determine their movements in and out of Kennady Lake.

Accumulations of ripe lake trout were captured in fall in nearshore areas around the island separating basins K1 and K2, suggesting that these are the primary spawning areas for Lake Trout in Kennady Lake. Sexually mature Lake Trout were also captured in all other basins in fall, indicating that other areas of the lake may also be used by Lake Trout for spawning. Positive identification of Round Whitefish spawning locations in Kennady Lake could not be verified as no ripe Round Whitefish were captured in fall gillnets. Peak round whitefish spawning activity appears to have commenced after field operations were concluded in 2004.

Average muscle mercury concentrations in lake trout collected in Kennady Lake, the Lake N16, Lake 410, and Kirk Lake exceeded the United States Environmental Protection Agency (U.S. EPA) risk-based criterion of 0.14 mg/kg and the Canadian Council of Ministers of the Environment (CCME) criterion for mercury in fish tissue for the protection of wildlife that consume aquatic biota (0.033 mg/kg). Average mercury concentrations were almost twice as high in Kirk Lake (0.60 mg/kg) than in Kennady Lake, Lake N16, or Lake 410 (0.24 mg/kg, 0.30 mg/kg, and 0.30 mg/kg, respectively). Average mercury

concentrations in these lakes were within the ranges of mercury concentrations found at other sub-Arctic lakes.

Average arsenic concentrations in lake trout collected from Kirk Lake, Lake 410, and Kennady Lake in 2004 were 0.05 mg/kg, 0.07 mg/kg, and 0.10 mg/kg, respectively. Although average arsenic concentrations in all four lakes were equal to or below detection limits (0.05 mg/kg), these results suggest that naturally occurring arsenic concentrations in Lake Trout may exceed the U.S. EPA risk-based criteria of 0.002 mg/kg.

Additional fish tissue chemistry surveys were undertaken in 2012 and 2013. This work allowed for the improvement of baseline understanding in waterbodies within the local study area (especially, the N lakes and reference lakes, and the D lakes within the Kennady Lake watershed), which did not have a large dataset throughout the environmental assessment.

20.3 Project-Environment Mitigation, Monitoring Programs & Management Plans

Following the Environmental Assessment and approval by the Federal Minister in October 2013, the project proceeded to the regulatory phase. Full detail of the measures and follow-up programs to mitigate the potential for adverse environmental impact resulting from the EIR are provided in the Gahcho Kué Panel's Report of Environmental Impact Review and Reasons for Decision. It is the commitments of De Beers (as outlined in the EIR process), and the measures and follow-up programs defined by the MVEIRB that have been incorporated in the Type A Water Licence and Land Use Permit applications, as well as a series of monitoring programs and management plans, included in the submission. The following section provides summary information on:

- general approach to evaluating and monitoring project-environment effects, including pathways considered for aquatic and terrestrial components of the biophysical environment as defined in the management plans and monitoring programs
- mitigation incorporated into the Updated Project Description (De Beers 2013a) as defined in developer commitments, as well as the monitoring and management plans.

20.3.1 GENERAL APPROACH

An environmental assessment was undertaken for the project that identified and assessed potential environmental effects of the project, and provided a determination of the significance of effects. As part of the regulatory phase of the project, potential environmental effects and mitigation are evaluated through a series of Environmental Monitoring and Management Plans. In a proactive initiative, De Beers prepared an Environmental Monitoring and Management Framework in 2012 that proposed the functional integration of environmental monitoring within an adaptive management approach (De Beers 2012a). As part of De Beers' ongoing commitment to responsible project management, a more detailed Adaptive Management Plan (AMP) for the project was submitted in 2013 as a supporting document for the Water Licence application. The following provides a summary

of the predicted impacts and the monitoring and management plans that have been developed to mitigate environment effects.

20.3.2 PROJECT DESCRIPTION

The project is situated at Kennady Lake, in a remote location in the NWT. The kimberlite ore bodies that will be mined are located below Kennady Lake, and are amenable to open-pit mining. Kennady Lake will be partially dewatered to allow access to the ore. The project will involve the following activities:

- redistribution and diversion of water within the watershed
- storage and management of overburden, mine rock and processed kimberlite
- management of solid and liquid wastes
- management of surface water and groundwater
- maintenance of site infrastructure and access throughout the life of the mine.

Valued components that include those identified by Aboriginal Parties during the Environmental Impact Review (EIR) process represent properties of the biophysical, cultural, social and economic environments that are of importance to society, and were identified in the EIS (De Beers 2010, 2011a, 2012b). The properties of the valued components that require protection are referred to as assessment endpoints (e.g., suitability of water quality to support a health aquatic ecosystem). Assessment endpoints are used to assess the significance of impacts and are tested and expressed through specific measurement endpoints (e.g., chemical concentration). The goal of EMPs is to collect data using measurement endpoints relating to Mine-environment interactions, thus allowing determination of Mine effects and subsequent assessment of the necessity to take management action.

Mine-environment interactions (i.e., pathways of effect) and predictions of potential effects were both defined in the EIS (De Beers 2010, 2011a, 2012a) and determine the need for EMPs. For example, the relationship between Mine-environment interactions, EIS predictions, and EMPs is demonstrated by the following:

- **Aquatic Environment:** During operations, processed kimberlite and mine rock will be placed in designated areas within the controlled area of the Mine. The EIS identified that phosphorus concentrations in Kennady Lake may increase following closure after Kennady Lake has been refilled and reconnected to the downstream waters. The predominant source of phosphorus is anticipated to be the geochemical loading from seepage inputs from the Fine Processed Kimberlite Containment (PKC) Facility under the assumption of permafrost-free conditions. As a result, the Kennady Lake ecosystem, although projected to remain oligotrophic (i.e., possessing <0.01 milligrams per litre [mg/L] total phosphorus), may be more productive due to the increased phosphorus concentration. The monitoring programs for the aquatic ecosystem will include the SNP within the controlled area of Kennady Lake (i.e., Areas 2 to 7), and the Aquatic Effects

Monitoring Program (AEMP) for Kennady Lake (following reconnection with Area 8) and downstream waterbodies; both programs will monitor phosphorus concentrations in water and sediment.

- **Terrestrial Environment:** As identified in the EIS, the Mine is anticipated to lead to the direct habitat loss within the Mine footprint, and indirect habitat alteration through sensory disturbance and dust that extend beyond the Mine footprint. Further, limited direct mortality of wildlife is anticipated to occur from mine activities (such as vehicle collisions or problem wildlife that have to be destroyed). The monitoring program for the terrestrial ecosystem, therefore, consists of a WEMP (Wildlife Effects Monitoring Program), a WWHPP (Wildlife and Wildlife Habitat Protection Plan), as well as a Vegetation and Soils Monitoring Program to evaluate impacts from dust, which was also identified by the Aboriginal Parties as a concern requiring monitoring.
- **Air Quality:** The Mine will release substances into the air (i.e., air emissions) during operation as a result of activities at the processing plant, as well as generators, incinerators, vehicle exhausts, and dust. These substances will settle out (i.e., air deposition) directly upon the water, or on the land, where they may be transported into the lakes and streams by snowmelt or runoff. While the concentrations of some metals were predicted to be above water quality guidelines in some small lakes immediately adjacent to the Mine area, the potential for effects to aquatic health from the dust and metals reaching the lakes was determined to be low. Air quality monitoring will take place for the Mine to confirm predicted effects and to support effect monitoring assessments relating to water quality, wildlife, vegetation, and soils.

20.3.3 MONITORING PLANS

20.3.3.1 AQUATIC EFFECTS MONITORING PROGRAM

The AEMP consists of four monitoring components: hydrology, water quality, sediment quality, and aquatic life (i.e., lower trophic communities [plankton and benthic invertebrates] and fish).

Information generated from the air quality and SNP (i.e., water quality, sediment quality and groundwater quality and quantity data from within the controlled area of the Mine) monitoring data will also support the AEMP. The overall approach for the program is based on identification of effects via comparisons between before and after conditions, control and impact sites (i.e., reference condition approach) and/or comparison of sites located along a gradient of exposure to potential impacts (i.e., gradient design). A set of core stations will be established and a consistent sampling design will be applied (where possible) across monitoring components.

The hydrology component of the AEMP focuses on measurement of seasonal water levels and flows, and channel/bank stability. This information will be important to the interpretation of biological monitoring data. Meteorological monitoring will be included. This information will also be used in support of hydrological modelling.

The water quality component of the AEMP focuses on chemical constituents that reflect geomorphology and condition of the watershed, and biological variables that indicate ecosystem health and biological productivity within the waterbody. Comparison of this information with water

quality guidelines (e.g., CCME) or site-specific water quality benchmarks and objectives, and between reference and exposure areas, allows for identification and assessment of Mine-related effects on water quality, and thus fish and fish habitat. Monitoring will take place during construction and through the life of the Mine, and beyond active closure, and will include measurement of field parameters, conventional parameters, major ions, metals, nutrients, and selected organic parameters. Sites will be located within the receiving environment immediately adjacent to the controlled area, and downstream of the Mine area, and sampling will follow a seasonal approach.

The sediment quality component of the monitoring program focuses on the physical and chemical properties of sediment in lakes and streams, reflecting not only the natural condition of the watershed but also potential Mine-related effects. Sediment monitoring will occur in close coordination with water quality and lower trophic communities monitoring, prior to and over the life of the Mine and into post-closure, and will include measurement of particle size, and sediment-associated nutrients and metals. Comparison of this information with sediment quality guidelines, baseline information, and between reference and exposure areas, will allow for identification and assessment of Mine-related effects on sediment quality and associated potential for effects on fish and fish habitat.

The aquatic life component of the monitoring program consists of lower trophic communities and fish. Plankton (i.e., phytoplankton and zooplankton) and benthic invertebrates are important food sources for fish and reliable indicators of water quality, sediment quality and the trophic status of waterbodies. The abundance and composition of lower trophic communities will be determined prior to and throughout the life of the Mine and into post-closure, and will occur on a seasonal basis during the open water period. Benthic invertebrate sampling will be coordinated with sediment sampling. Fish will be monitored for health (e.g., growth, reproduction, and development) and tissue chemistry (e.g., quality for consumption). Monitoring for fish presence and movement will also be conducted in the streams downstream of Kennady Lake in relation to the flow mitigation plan. Fish habitat will be monitored through the review of the results of the hydrology, water and sediment quality, and lower trophic level monitoring programs. Fish sampling will occur at an appropriate sampling frequency periodically throughout the life of the Mine and into post-closure.

The AEMP will provide adaptive management details in support of the Water Management Plan (De Beers 2013p) and the SNP (Annex A of the Water Licence). The AEMP focuses on the receiving environment, outside of the controlled area. The focus of the SNP is largely confined to within the controlled area, with the exception of the sampling stations in Lake N11 and Area 8 (i.e., at the diffusers). The diffuser stations, as with other mining operations, are anticipated to be included in the AEMP reporting. The common link among the AEMP and SNP is the management of water in, and downstream of, the Kennady Lake ecosystem due to the Mine.

Action levels within the AEMP are specific to water quality (its drinkability and potential to affect aquatic life), fish health and tissue quality, and fish movement (and abundance, particularly in latter stages of the Mine operations, i.e., post-closure). The fish species to be studied will include a small

bodied species (i.e., the fish health sentinel species), and those which have been the focus of the most attention during the environmental assessment, i.e., lake trout, arctic grayling and northern pike.

Significance thresholds are broadly organised into three categories centred on the key assessment endpoints (Section 2) and those identified by Aboriginal Parties during the EIR process, and include the following:

- Water is safe to drink
- Fish are safe to eat
- Ecological function in the aquatic ecosystem is maintained.

Significance thresholds currently drafted for the AEMP, which have been reviewed by Aboriginal parties during the EIR process as well as subsequent workshops, community visits and site visits as described in the Engagement Plan, include the following:

1. Drinking Water & Fish Consumption

- Water is not drinkable (human health and/or wildlife risk):
 - aesthetics will be considered through the action levels only;
 - water safe for consumption will be considered through a human health and/or wildlife risk assessment for drinking water;
 - Construction, Operations, and Closure: the water in waterbodies adjacent to, and downstream of, Kennady Lake is not drinkable; and
 - Post-closure: the water in Kennady Lake is not drinkable.
- Fish are not safe for consumption (human health and/or wildlife risk):
 - palatability will be considered through the action levels only;
 - fish safe for consumption will be considered through a human health and/or wildlife risk assessment of measured fish tissue parameters
 - Construction, Operations, and Closure: fish in waterbodies adjacent to, and downstream of, Kennady Lake are not safe to eat; and
 - Post-Closure: fish in Kennady Lake are not safe to eat.

2. Ecological Function

- Inadequate food for fish, or
- Fish unable to survive, grow, or reproduce, or
- Sustained absence of a fish species:
 - Individual components (i.e., hydrology, water quality, sediment quality, plankton community, benthic community, fish health and tissue chemistry) are considered through the action levels only.

- Construction, Operations, and Closure: fish in waterbodies adjacent to, and downstream of, Kennady Lake have inadequate food, or are unable to survive, grow, or reproduce, or there is a sustained absence of a fish species.
- Post-closure: fish in Kennady Lake have inadequate food, or are unable to survive, grow, or reproduce, or there is a sustained absence of a fish species.

Changes to water quality, aquatic life abundance and distribution, and fish health and tissue quality will be measured using standard approaches that are consistent with, or added to, those used during the environmental assessment. Where changes are identified for specific aquatic components, a weight of evidence approach will be used to integrate the monitoring data from each aquatic component to identify the impact to the aquatic ecosystem.

20.3.3.2 SURVEILLANCE NETWORK PROGRAM

The SNP consists of water, sediment, and effluent (i.e., water management pond discharge) quality monitoring primarily within the controlled area boundary of the Mine, with the exception of the diffuser sampling locations that are located immediately outside the controlled area (i.e., Area 8 during early construction [initial dewatering], and Lake N11 during construction and early operations [dewatering and operational discharge]). The information from this program will be used to verify water quality predictions within the controlled area (e.g., the water management pond with respect to dewatering and operational discharges to Lake N11 and Area 8) and assess compliance with water licence limits. Sampling will include collection of water samples for chemical analysis (e.g., field parameters, conventional parameters, major ions, metals, nutrients, and selected organic parameters), measurement of flow (e.g., operational WMP effluent discharge and groundwater inflow rates), and sediment samples at the diffuser stations for chemical analysis (e.g., physical properties, metals, nutrients, and selected organic parameters). Monitoring will occur prior to and through the life of the Mine, and during closure (i.e., the refilling of Kennady Lake). Locations targeted for monitoring include points of discharge (i.e., diffuser locations), the water management pond, collection ponds, seepage, minewater, and surface runoff.

While the SNP is a compliance monitoring requirement under the water licence, select data from the SNP are directly relevant to the AEMP (e.g., quality and quantity of water discharged from Kennady Lake to Lake N11 during dewatering). The AEMP and SNP have been designed to complement each other and avoid duplication in data collection and reporting efforts. In addition, action levels and benchmarks for applicable data collected in the SNP will be identified and assessed as part of the AEMP.

20.3.3.3 WILDLIFE MONITORING

Wildlife monitoring will be conducted through the WEMP and the WWHPP. The WWHPP (De Beers, 2013k) outlines the policies, practices, designs, and procedures that will be implemented to mitigate direct Mine-related effects to wildlife and wildlife habitat. The intent is to reduce effects to wildlife, and maintain safety for wildlife and humans. The WEMP (De Beers 2013d) will monitor the indirect effects to wildlife, and also includes contributions to regional monitoring initiatives.

Effects to wildlife at the site level cannot trigger significance as defined in the EIS (De Beers 2010). Significance follows from effects to abundance and distribution. These are effects that occur at the scale of the population range or the regional study area, not within the mine footprint. Changes will be measured using all available information, including results from the WEMP and WWHPP, information from other mines operating in the region, and monitoring undertaken by government agencies. Significance will be estimated through a weight of evidence approach, where high magnitude changes occurring over a large geographic extent will contribute more to the assessment than smaller scale effects.

The significance thresholds as defined the EIS (De Beers 2010) are specific to caribou, grizzly bear and wolverine, as the species that have been the focus of the most attention during the environmental assessment, and which are receiving the most monitoring effort. The significance thresholds for these species are:

1. Wildlife Population

- A sustained decrease in the abundance and/or distribution (i.e., a decline in resilience and persistence) of a wildlife population.
- A significance threshold is not proposed for direct habitat loss, as this will be dictated and monitored through the land use permit.

2. Hunting Opportunity

- A sustained loss of hunting opportunities.
- Management thresholds at the site level (such as the actions resulting from wildlife mortality or persistent on-site problem wildlife) will be defined through the WEMP and WWHPP documents.

20.3.3.4 VEGETATION & SOILS MONITORING PROGRAM

Vegetation and soils surrounding the Mine footprint are susceptible to change from dust deposition by the Mine. Dust deposition will be measured in areas where vegetation and soils are considered most sensitive along a transect extending downwind from the Mine. Vegetation, soil, dust and microclimate will be monitored for change at these areas. The program will be designed to measure plant growth, soil properties, dust deposition levels, and microclimate (soil moisture and temperature).

Significance thresholds currently drafted are limited to the vegetation monitoring program, and include the following:

20.3.3.5 PERSISTENCE OF VEGETATION

A sustained decrease in the persistence of vegetation ecosystems and plant populations.

Persistence is first considered through action levels as a high magnitude impact over a regional scale resulting in a decrease in richness and relative abundance of major taxonomical plant groups that are important to ecosystem function and traditional land use.

It is anticipated “sustained” will be defined as occurring over a minimum of three consecutive years of monitoring.

Residual effects were not classified and environmental significance was not evaluated for soils within the EIS (De Beers 2010, 2012b); therefore, there are no significance thresholds for soils.

20.3.3.6 AIR QUALITY & EMISSIONS MONITORING & MANAGEMENT PLAN

Mine construction and operations are expected to result in atmospheric emissions due to fossil fuel combustion and fugitive dust. Emissions from power generators and the waste incinerators will be tested initially and periodically after start-up. A network of air quality monitoring stations will be established on the perimeter of the Mine site as well as within a wider area. Air quality will be tested for SO₂, NO₂, total suspended particulate (TSP), and PM_{2.5}.

The Air Quality and Emissions Monitoring and Management Plan details action levels, benchmarks, and management responses that adapt to unacceptable and unanticipated changes in air quality and emissions over the life of the Mine. For example, low action levels include the exceedance of the applicable NWT air quality standards for SO₂, NO₂, TSP and PM_{2.5}.

Residual effects were not classified and environmental significance was not evaluated for air quality within the EIS (De Beers 2010); therefore, there are no significance thresholds for air quality monitoring.

20.3.3.7 GROUNDWATER MONITORING PROGRAM

Excavated pits within the Mine area are expected to receive a net influx of groundwater, some of which is anticipated to have elevated concentrations of total dissolved solids (TDS) relative to surface water. Groundwater quality and quantity will be monitored for trends over time, and will be incorporated into the SNP. Monitoring will take place throughout the life of the Mine and will occur using wells and within open pits.

Residual effects were not classified and environmental significance was not evaluated for groundwater within the EIS (De Beers 2010, 2011a, 2012b); therefore, there are no significance thresholds for groundwater. The influence of the mining activity to groundwater, and the groundwater influence to water quality in the EIS are incorporated into the residual effects analysis to water quality. As a result, the significance thresholds for the AEMP incorporate the influence of groundwater to water quality. In addition, applicable data, based on quantity and quality, collected in the groundwater monitoring program will be identified and assessed as part of the SNP.

20.3.3.8 GEOCHEMICAL CHARACTERIZATION PLAN

The Geochemical Characterization Plan will involve sample collection and analysis that will indicate the magnitude and variability in the geochemical characteristics of mine materials, and ensure the appropriate placement of materials at the Mine. Monitoring will occur throughout the life of the Mine. The information collected will be reviewed on an ongoing basis to ensure that the mine plan and

mitigation options meet the environmental objectives for the Mine. As outlined in the Water Licence, the Geochemical Characterization Plan (De Beers 2013h) provides management details in support of the Processed Kimberlite and Mine Rock Management Plan (De Beers 2013o).

The Geochemical Characterization Plan (De Beers 2013h) consists of two monitoring components: mine rock monitoring, and drainage quality monitoring. The approach for the program is to track the characteristics, amount and placement of mine rock from the open pits to confirm that rock is being used according to the recommendations in the Processed Kimberlite and Mine Rock Management Plan (De Beers 2013o). The composition of seepage and runoff from mine rock and processed kimberlite storage facilities will be tracked to allow for identification of signs of incipient acid rock drainage and / or metal leaching from mine materials.

Mine rock characterization focuses on samples collected from the open pits during mine operations. Samples will be submitted for total sulphur analysis, and rock will be classified as potentially acid generating (PAG) or non-PAG. Rock will then be used for construction or placed in mine rock piles according to the Processed Kimberlite and Mine Rock Management Plan (De Beers 2013o). Material used for construction will be non-PAG, and PAG rock will be sequestered within the interior of the mine rock piles or placed within a pit. The placement of rock will be confirmed by detailed geochemical analysis of rock samples collected from the site during bi-annual geochemical audits.

The drainage quality component of the geochemical characterization program focuses on chemical constituents that may be indicative of signs of incipient acid/alkaline rock drainage and metal leaching. Runoff and seepage from key mine facilities will be monitored during construction and through the life of mine, including measurements of field parameters, conventional parameters, major ions, metals and nutrients. Sites will be located adjacent to key mine areas, or where zones of obvious seepage or runoff are identified. The results of SNP and internal mine monitoring will be used in this evaluation as necessary.

The Geochemical Characterization Plan (De Beers 2013h) will not operate within the standard Adaptive Management Framework; therefore, there are no Action Levels or Significance Thresholds directly defined for the Geochemical Characterization Plan. Rather, PAG status and projected PAG volumes will direct the management of mine rock and kimberlite material during operations (De Beers 2013o).

20.3.4 MANAGEMENT PLANS

Various management plans have been developed for the Mine. They have been drafted in support of the Water Licence and Land Use Permit. These plans are briefly described presently.

20.3.4.1 CONCEPTUAL CLOSURE & RECLAMATION PLAN

The Conceptual Closure and Reclamation Plan (De Beers 2013i) provides the basis for a closure plan for the Mine that will return the site and affected areas around the mine to technically viable and, where practicable, self-sustaining ecosystems that are compatible with a healthy environment and with human activities. It is recognised that the Conceptual Closure and Reclamation Plan is a living

document, which will be revised through the course of mine operations. The Conceptual Closure and Reclamation Plan contains information on the following:

- guiding principles for closure and reclamation
- site wide short-term and long-term objectives
- closure and reclamation of site-specific elements (e.g., open pit mines; mine rock and processed kimberlite containment facilities; site infrastructure)
- communication and engagement with regulators and aboriginal parties
- consideration of Traditional Knowledge
- implementation schedule
- closure costs
- reporting.

20.3.4.2 EXPLOSIVES MANAGEMENT PLAN

The Explosives Management Plan (De Beers 2013j) describes how impacts to water quality and wildlife will be minimised during blasting operations. This includes detailing measures for the prevention and management of spills, and point source control, to reduce release of ammonia to the environment. The Explosives Management Plan focuses on safety and environmental protection, and outlines Federal and Territorial regulations relating to the control and use of explosives. The Explosives Management Plan describes the on-site manufacture of explosives and provides information on:

- explosives management (blast management organization, on-site storage and handling)
- blasting operations (planning, safety procedures, vehicles and equipment, adverse weather, by-products, misfires, reporting and data management, improvements, spill response).

20.3.4.3 EMERGENCY RESPONSE PLAN & SPILL CONTINGENCY PLAN

The Emergency Response Plan (De Beers 2013l) and Spill Contingency Plan (De Beers 2013m) facilitate prompt, efficient and safe clean-up of materials used during mine construction and operations, identify responsibilities and reporting procedures of the Emergency Response Team, and provide support and information on resources, facilities and trained personnel in the event of a spill or emergency. Information is provided on:

- response organization and reporting responsibilities, including training courses and spill response exercises
- Mine cleanup strategy for initial response, major on-site facilities with greatest potential for a large or environmentally significant spill, prevention measures and emergency response actions and procedures
- basic spill response theory and actions

- spill response equipment
- hazardous material information and spill reporting.

20.3.4.4 WASTE MANAGEMENT FRAMEWORK

The Waste Management Framework (De Beers 2013n) is an umbrella and plain language summary document describing how waste will be managed at the Mine site. The Waste Management Framework is supported by details provided in seven supporting documents, which are described in the following sub-sections.

20.3.5 PROCESSED KIMBERLITE & MINE ROCK MANAGEMENT PLAN

The Processed Kimberlite and Mine Rock Management Plan (De Beers 2013o) is a how-to- manual for managing processed kimberlite and mine rock at the Mine. The Processed Kimberlite and Mine Rock Management Plan describes:

- mine rock and processed kimberlite management (schedules, quantities, distribution, geochemical characteristics)
- operational procedures (including in-pit storage) and water management for mine rock and processed kimberlite
- contingency plan for changes in proportions of waste streams
- monitoring during the operational phase of the mine.

Protocols relating to the management of processed kimberlite and mine rock are included in the Geochemistry Characterization Plan (De Beers 2013h).

20.3.6 WATER MANAGEMENT PLAN

The Water Management Plan (De Beers 2013p) describes the proposed water and sewage management system at the Mine site. The Water Management Plan includes:

- the objectives, strategies, roles and responsibilities for water management at the mine site
- a detailed description of water management for the two principle water systems on site:
 - mine water (including dewatering of Kennady Lake; water management pond operations; open pit seepage water management; runoff water collection system; and water management during closure); and
 - site water (raw water intake; potable water; domestic water supply; sewage collection and treatment plant); and
 - effluent quality criteria.

Action levels and benchmarks relating to surface water and effluent management are included in the AEMP (De Beers 2013c).

20.3.7 SEDIMENT & EROSION MANAGEMENT PLAN

The Erosion and Sediment Management Plan (De Beers 2013q) describes the sediment and erosion management strategy at the Mine site:

- the objectives of sediment and erosion management on-site
- sources of sediment and erosion at the mine
- erosion and sediment management strategies associated with dewatering and operational water discharges from Kennady Lake, water diversions from the Kennady Lake watershed, water level rises, dyke construction and breaching, and surface runoff.

20.3.8 INCINERATOR MANAGEMENT PLAN

The Incinerator Management Plan (De Beers 2013r) addresses the management of the incinerators at the Mine. The incinerator is intended to use thermal treatment to reduce the volume of domestic waste associated with Mine operations. The purpose of the Incinerator Management Plan is to provide an overview of the activities involved in the operation of the incinerator at the Mine (De Beers 2013r). This includes the operation of the incinerator and collection of data that will be used in the annual air quality monitoring report.

20.3.9 NON-HAZARDOUS SOLID WASTE MANAGEMENT PLAN

The Non-hazardous Solid Waste Management Plan (De Beers 2013s) provides guidance on managing domestic waste and sewage on-site, including proper handling and disposal of non-hazardous wastes during Mine construction and operations, such that potential effects on the environment are minimised and regulatory requirements are met. The Non-hazardous Solid Waste Management Plan describes:

- non-hazardous solid wastes generated at the site
- practices and procedures for the collection, storage, transport and disposal of non-hazardous wastes
- monitoring and mitigation procedures for non-hazardous wastes
- procedures that promote reduction, recovery, reuse and recycling of wastes.

20.3.10 HAZARDOUS MATERIALS & WASTE MANAGEMENT PLAN

The Hazardous Materials and Waste Management Plan (De Beers 2013t) establishes the principles of hazardous materials management during the operations of the Mine. The Hazardous Materials and Waste Management Plan describes:

- hazardous materials and wastes associated with Mine operations
- legislative requirements and regulations pertaining to their transportation, handling, storage and potential for environmental effects

- principles pertaining to the identification, classification and storage of hazardous materials, protective clothing and equipment, disposal of wastes, and emergency measures
- considerations relating to the transportation of hazardous materials
- descriptions of appropriate storage facilities, inspection and monitoring measures, record keeping and personnel training for various classes of hazardous materials (i.e., petroleum/oils/lubricants, explosives, other).

20.3.11 LANDFARM MANAGEMENT PLAN

The Landfarm Management Plan (De Beers 2013u) outlines the location that has been identified for a landfarm, if required, conceptual design criteria, operating procedures, including a soil bioremediation procedure, and employee health and safety information.

In general, the site-constructed and operated landfarm will receive soils and snow that have been contaminated with hydrocarbons generated from the mine operations. Contaminated soils will be treated at the landfarm using *ex-situ* bioremediation. Hydrocarbon contaminated water at the landfarm will be initially treated through an oil/water separator, and eventually transferred to the sewage treatment plant and then the water management pond.

20.3.12 ADAPTIVE MANAGEMENT & REPORTING

Adaptive Management is a systematic, transparent process for the response to results of a monitoring program (WLWB 2010) that identifies a potential environmental effect, a shift from EIS predictions or if environmental conditions remain as predicted, and the efficacy of mitigation. It is a critical component of the environmental monitoring plan. This process, which is built into each of the management plans and monitoring programs, will allow De Beers to understand how the project is tracking with respect to its operation and environmental management, but more importantly to take action when monitoring results indicate that a pre-defined level of environmental change or effect to any biophysical component is occurring. The monitoring programs and management plans will be reviewed and updated as appropriate and necessary (e.g., when circumstances within the mine operation, or regulatory requirements, change).

The monitoring programs and management plans will generate annual reports that inform on the activities that have occurred each year, and on the conditions of the receiving environment. The information will be reported as part of the regulatory requirements the Water Licence and Land Use Permit, and form the basis for constancy, or modification or update to the mine operation/mitigation.

20.4 Socioeconomic Agreement with GNWT

A Socioeconomic Agreement (SEA) for the project was signed with the GNWT on June 28, 2013. The Socio Economic Agreement establishes the methods and procedures by which De Beers and the GNWT will work together to maximize the benefits of the project and to minimize the negative socio-economic impacts.

The SEA establishes hiring priorities and employment incentives for the project, training and employment objectives, business procurement objectives and it outlines how De Beers and the GNWT will work together to ensure the health and cultural well being of NWT Residents. A copy of the Socio Economic Agreement is posted on the GNWT website.

SECTION 21 CAPITAL & OPERATING COSTS

21.1 Capital Cost Estimate

Hatch has compiled the initial capital cost estimate and JDS has compiled the sustaining capital costs and the reclamation and closure costs. The Authors are of the opinion that the capital costs presented are a fair and accurate assessment of the capital costs to construct the project, within normal levels of accuracy as defined by AACE for a Feasibility Study.

21.1.1 INITIAL CAPITAL COST AND BASIS OF ESTIMATE

The purpose of the capital cost estimate is to establish the project budget to sufficient accuracy to allow the GKJV to make investment decisions. The estimate will provide the pertinent cost data to establish the control budget for moving forward into project execution (procurement and field construction). This is achieved by implementing the practices and procedures outlined in the feasibility study estimate plan, which in-turn is aligned with AACE recommended practices.

The capital cost estimate was compiled based on the following parameters:

- Structuring and coding the estimate into an agreed and updated Work Breakdown Structure (WBS) and Commodity Breakdown Structures (CBS) reflecting the scope of work.
- Foreign currency elements of quoted prices were converted to Canadian dollars.
- Conducting a quantitative risk analysis to establish the required level of contingency.
 - Based on Quantitative Risk Analysis (QRA), the estimate accuracy is minus 7.9% to plus 8.6% (which exceeds an AACE Class 2).
 - The selected contingency is C\$75.6 million or 9.4%, which represent approximately a P85 level of confidence.
- A combination of committed and firm bid prices for major mobile mining equipment were used for the estimate; realised actual costs were used for certain mobile support equipment and budget prices for the remainder of the minor mobile equipment were obtained from a number of proven suppliers.
- Firm and budget proposals were received for select equipment packages.
- Material Take-Offs (MTOs) were developed from 3D model layouts, general arrangements and design calculations for Site Preparation, Concrete, Structural Steelwork, Mechanical Bins and Chutes, Process Piping and Valves, Electrical, and Instrumentation. Pricing was developed based on Hatch recent experience with similar projects.

- Labour rates were obtained from the general contractor (Ledcor Projects Inc.) who has worked in the Arctic (including the construction of the neighbouring De Beers operated Snap Lake Diamond Mine) and is based in the Edmonton region.
- Committed unit labour rates for earthworks equipment operators were used for activities occurring before the arrival of the Owners mining personnel.
- Labour productivity was calculated based on historical project experience with cold environment projects.
- Calculating the costs for freight.
- Scheduling the work utilising the project schedule outlined in feasibility study execution plan.
- Detailed estimates of indirect costs. For this project, indirect items included:
 - Contractor general expenses
 - EPCM costs
 - Bulk diesel
 - Power plant operation during construction phase (excluding fuel)
 - GK Winter spur road construction and maintenance Capital spares
 - Truck cargo freight
 - TCWR winter road fees
 - Passenger air charters
 - Owner's costs, including:
 - Owners project management team
 - Owners pre-production site operations labour
 - Owners General & Administration items
 - General Site Indirects
 - Camp Catering and cleaning
 - Pre-operational readiness and commissioning services
 - Contractor assistance during commissioning
- Applying escalation to costs scheduled to be spent beyond 2013.

21.1.1.1 CAPITAL COST ESTIMATE EXCLUSIONS

The following costs are not included in the capital cost estimate:

- Reimbursable Taxes and Duties
- Schedule acceleration costs
- Schedule delays and associated costs, such as those caused by:
 - Unexpected site conditions
 - Unidentified ground conditions

- Unavailability of the ice road
- Labour disputes
- Force majeure
- Permit applications (based on October 2013 receipt of permits to allow field work to begin)
- Further delays to the start of engineering
- Late arrival of equipment
- Development fees and approval costs beyond those specifically identified
- Cost of any disruption to normal operations
- Event risk
- Financing costs
- Foreign exchange fluctuations
- Operator management fee
- Cost associated with third party delays
- Working capital (addressed in financial model and financial analysis section)
- Owner’s Reserve
- Two-year operating spares (commissioning spares are included)
- Development fees and approval costs of Statutory Authorities
- Change in law and regulations
- Soil decontamination and disposal costs
- Cost of any disruption to normal operations
- OPEX evaluation (part of separate exercise)
- De Beers Management Fee
- Operational costs occurring during the Ramp-Up Period.

21.1.1.2 CAPITAL COST ESTIMATE SUMMARIES

The capital cost for the project is C\$1,019 M including C\$75.6 M of contingency, which represents approximately P85 level of confidence.

Table 21.1 and Table 21.2 give summaries of the capital cost by WBS and Commodity.

Table 21.1: Capital Cost Estimate by WBS

WBS	Description	CAD (\$M)
1000	Mine Operations	\$ 188.8
2000	Site Development and Roadworks	\$ 10.3
3000	Process Facilities	\$ 134.4
4000	Utilities	\$ 48.9
5000	Ancillary Buildings	\$ 51.8
6000	Waste and Water Management	\$ 6.1
7000	Off-Site Facilities	\$ 0.4
Subtotal - Direct Costs =		\$ 440.7
8000	Owner's Management Costs	\$ 100.2
9000	Indirect Costs	\$ 360.5
Subtotal - Owner's + Indirect Costs =		\$ 460.7
9900	Contingency	\$ 75.6
9910	Escalation	\$ 42.0
Total - Project =		\$ 1,019.0

Table 21.2: Capital Cost Estimate by Commodity

CBS	Description	CAD (\$M)
C	Civil Works / Site Development and Improvements	\$ 204.8
B	Concrete Cast-in Place and Precast	\$ 14.5
S	Structural Elements and Metal Fabrications	\$ 18.0
A	Architectural Components and Finishes	\$ 44.5
M	Mechanical Equipment	\$ 87.9
P	Piping and Fittings	\$ 14.1
E	Electrical Components	\$ 39.9
J	System Controls / Instrumentation / Telecommunications	\$ 16.6
V	Contractor's Indirect Costs - General Conditions	\$ 76.5
W	Owner's Costs	\$ 100.2
Y	Project Indirect Costs	\$ 262.2
Z	Financial Risks and Project Contingency	\$ 139.7
Total - Project =		\$ 1,019.0

21.1.2 SUSTAINING CAPITAL COSTS

“Sustaining capital” consists of identified capital expenditures that occur during the operating phase (after the initial capital phase).

These items were estimated in the same manner as the initial capital cost estimate outlined above and are summarised in Table 21.3. A 9% contingency factor was applied to the sustaining capital requirements (equivalent to the contingency on “non-sunk” costs in the CAPEX estimate). In addition to the identified sustaining capital requirements, an annual \$1 M minor asset allowance was provided to account for “undefined” capital requirements for miscellaneous projects.

Table 21.3: Summary of Sustaining Capital Costs, by Year

Total by Activity	Unit	2016	2017	2018	2019	2020	2021	2022	2023	2024	2025	2026	2027	2028	Total
Mining & Earthworks															
250mm Blast Hole Drill	C\$ (M)	-	2.80	-	-	-	-	-	-	-	-	-	-	-	2.80
240 ton Haul Truck	C\$ (M)	-	4.44	8.89	-	-	-	-	-	-	-	-	-	-	13.33
Rubber Tired Dozer	C\$ (M)	-	-	1.10	-	-	-	-	-	-	-	-	-	-	1.10
17m3 Wheel Loader	C\$ (M)	-	-	4.97	-	-	-	-	-	-	-	-	-	-	4.97
Initial Tires for New HME	C\$ (M)	-	0.23	0.86	-	-	-	-	-	-	-	-	-	-	1.09
Diesel Pick-Up (Blasters Box)	C\$ (M)	-	-	0.08	0.08	-	-	0.08	0.08	-	-	-	-	-	0.33
Diesel Crew Cab Pick-Up	C\$ (M)	-	0.12	-	-	0.12	-	-	0.12	-	-	-	-	-	0.36
Groundwater Monitoring Sys.	C\$ (M)	-	0.24	-	-	0.12	-	-	-	-	-	-	-	-	0.36
Pit Dewatering Pumps	C\$ (M)	-	-	0.23	0.23	-	-	0.23	-	-	-	-	-	-	0.70
Pit Dewatering Piping	C\$ (M)	-	-	0.04	0.04	0.11	-	-	-	-	-	-	-	-	0.19
Dam & Dyke Liners	C\$ (M)	-	0.19	-	0.04	0.07	-	-	-	-	-	-	-	-	0.30
Dam/Dyke Construction QC	C\$ (M)	-	0.97	0.43	0.63	0.74	0.18	0.18	0.18	0.64	0.18	-	-	-	4.12
Dam/Dyke Final Design	C\$ (M)	-	0.33	-	-	-	-	-	-	-	-	-	-	-	0.33
Processing															
HPGR Capital Repairs	C\$ (M)	-	-	-	1.73	-	-	1.73	-	-	1.73	-	-	-	5.18
Tailings Line to Hearne	C\$ (M)	-	-	-	-	1.35	-	-	-	-	-	-	-	-	1.35
Misc. Plant Replacements	C\$ (M)	-	-	-	-	2.00	-	2.00	-	-	-	-	-	-	4.00
Infrastructure															
10,000 m3 Fuel Tank	C\$ (M)	-	2.83	-	-	-	-	-	-	-	-	-	-	-	2.83
Power Generation															
Generator Capital Repairs	C\$ (M)	-	0.83	1.38	0.99	0.83	2.20	0.62	0.81	1.57	1.04	2.20	-	1.04	13.50
General & Administrative															
IT & Comm. Upgrades	C\$ (M)	-	-	-	-	-	1.00	1.00	-	-	-	-	-	-	2.00
Totals															
Subtotal SIB (excl. Contingency)	C\$ (M)	-	12.98	17.98	3.74	5.33	3.38	5.84	1.19	2.21	2.94	2.20	-	1.04	58.84
Contingency on Identified Items	C\$ (M)	-	1.17	1.62	0.34	0.48	0.30	0.53	0.11	0.20	0.26	0.20	-	0.09	5.30
Minor Asset Allowance	C\$ (M)	-	1.00	1.00	1.00	1.00	1.00	1.00	1.00	1.00	1.00	1.00	1.00	1.00	12.00
Grand Total SIB	C\$ (M)	-	15.15	20.60	5.08	6.81	4.69	7.37	2.29	3.41	4.21	3.40	1.00	2.13	76.14

21.1.3 CLOSURE & RECLAMATION COSTS

21.1.3.1 DEMOLITION

Ore processing activities are scheduled to conclude in mid-2028. With the low-level of mining requirements, the site equipment that was normally part of the services fleet will become the demolition fleet. It is assumed that specialised equipment needed for demolition will be transported to site on the 2028 or 2029 winter road. This equipment would consist of excavators and demolition attachments such as hydraulic hammers and grapples. Demolition is assumed to commence immediately upon cessation of plant operations and continue into 2029. The full demobilization of salvageable equipment would be scheduled over two shortened 30-day winter road seasons in 2029 and 2030, with most of the mobile equipment, surplus inventory and easily dismantled equipment and materials shipped out during the 2029 winter road. Some of the surplus mining fleet would have been sold and shipped out in previous years. During 2029, the completion of a modified smaller camp, infrastructure, and equipment service facilities for the lake refilling stage of the operation would be carried out.

The total cost estimate for the demolition phase is C\$29.5 M.

Progressive Reclamation

Progressive reclamation activities are conducted throughout the mine as a normal part of mine operations. During the later years of the mine operations, mine rock, fine PK and coarse PK are all deposited in the mined out Hearne and 5034 pits. As such, mine rock piles, along with the Area 2 fine PK facility and the coarse PK pile utilised in the earlier years will have been reclaimed prior to the end of the mine operations. An estimated of the mine operating costs attributable to progressive reclamation is shown in Table 21.4.

GAHCHO KUÉ PROJECT 2014 FEASIBILITY STUDY N.I. 43-101 TECHNICAL REPORT

Table 21.4: Summary of Mine Reclamation & Closure Costs

Progressive Reclamation Costs (Included in Opex)			2017	2018	2019	2020	2021	2022	2023	2024	2025	2026	2027	2028	Total			
ACTIVITY	Units	Unit Cost																
Dozing of:	\$	\$0.35	\$ -	\$ -	\$ -	\$ -	\$ -	\$ -	\$ 106,997	\$ 130,069	\$ 130,069	\$ 130,069	\$ 130,069	\$ 130,069	\$ 757,340			
South Dump	m2								152,211	152,211	152,211	152,211	152,211	152,211	913,267			
West Dump	m2								153,494	153,494	153,494	153,494	153,494	153,494	920,961			
Coarse PK	m2									65,920	65,920	65,920	65,920	65,920	329,600			
Waste Rock Capping of:	\$	\$3.21	\$ -	\$ -	\$ -	\$ -	\$ -	\$ -	\$ -	\$ -	\$ 1,821,937	\$ 1,821,937	\$ 1,821,937	\$ 1,821,937	\$ 7,287,749			
Fine PK	tonnes		-	-	-	-	-	-	-	-	402,370	402,370	402,370	402,370	1,609,482			
Coarse PK	tonnes										164,800	164,800	164,800	164,800	659,200			
Coarse PK Capping of:	\$	\$3.21	\$ -	\$ -	\$ -	\$ -	\$ -	\$ -	\$ 1,905,307	\$ 6,745,888	\$ 1,628,254	\$ -	\$ -	\$ -	\$ 10,279,449			
Fine pk	tonnes		-	-	-	-	-	-	593,123	2,100,000	506,877	-	-	-	3,200,000			
Progressive Reclamation Expenditure within Opex			\$ -	\$ -	\$ -	\$ -	\$ -	\$ -	\$ 2,012,304	\$ 6,875,957	\$ 3,580,260	\$ 1,952,006	\$ 1,952,006	\$ 1,952,006	\$ 18,324,538			
These are expenditures that occur DURING the normal operation of the mine/plant																		
These are expenditures that occur AFTER the normal operation of the mine/plant																		
Note shift in time scale versus above:			2029	2030	2031	2032	2033	2034	2035	2036	2037	2038	2039	2040	2041	Total		
Phases >>>			Demo & Lake	Demo & Lake	Lake Refilling and Monitoring													
SUMMARY																		
Included in Opex (2028)			\$CDN	\$ 26,538,654	\$ -	\$ -	\$ -	\$ -	\$ -	\$ -	\$ -	\$ -	\$ -	\$ -	\$ -	\$ -	\$ 26,538,654	
Additional to Opex			\$CDN	\$ 3,214,220	\$ 2,434,615	\$ 974,961	\$ 974,961	\$ 974,961	\$ 974,961	\$ 974,961	\$ 974,961	\$ 974,961	\$ 974,961	\$ 974,961	\$ 974,961	\$ 1,550,000	\$ 16,948,439	
TOTAL CLOSURE/RECLAMATION SPEND			\$CDN	\$ 29,752,874	\$ 2,434,615	\$ 974,961	\$ 974,961	\$ 974,961	\$ 974,961	\$ 974,961	\$ 974,961	\$ 974,961	\$ 974,961	\$ 974,961	\$ 974,961	\$ 1,550,000	\$ 43,487,093	
DETAIL by PHASE																		
Demolition Phase				2029	2030	2031	2032	2033	2034	2035	2036	2037	2038	2039	2040	2041	Total	
Severance & Labour	Included in Opex	\$CDN	\$ 23,788,654														\$ 23,788,654	
Equipment	Included in Opex	\$CDN	\$ 1,000,000														\$ 1,000,000	
Materials	Included in Opex	\$CDN	\$ 1,750,000														\$ 1,750,000	
G&A (Winter Road)	additional	\$CDN	\$ 1,459,654	\$ 1,459,654													\$ 2,919,308	
G&A (Outbound Truck Freight less SV)	additional	\$CDN	\$ -	\$ -													\$ -	
Demolition Phase Total Spend			\$CDN	\$ 27,998,308	\$ 1,459,654	\$ -	\$ -	\$ -	\$ -	\$ -	\$ -	\$ -	\$ -	\$ -	\$ -	\$ -	\$ 29,457,962	
Included in Opex (accounted for in 2027)			\$CDN	\$ 26,538,654	\$ -	\$ -	\$ -	\$ -	\$ -	\$ -	\$ -	\$ -	\$ -	\$ -	\$ -	\$ -	\$ 26,538,654	
Additional to Opex			\$CDN	\$ 1,459,654	\$ 1,459,654	\$ -	\$ -	\$ -	\$ -	\$ -	\$ -	\$ -	\$ -	\$ -	\$ -	\$ -	\$ 2,919,308	
Lake Refilling and Monitoring Phase				2029	2030	2031	2032	2033	2034	2035	2036	2037	2038	2039	2040	2041	Total	
Labour & Camp/Catering	\$CDN	\$ 322,000	\$ 322,000	\$ 322,000	\$ 322,000	\$ 322,000	\$ 322,000	\$ 322,000	\$ 322,000	\$ 322,000	\$ 322,000	\$ 322,000	\$ 322,000	\$ 322,000	\$ 322,000	\$ 322,000	\$ 3,864,000	
Equipment	\$CDN	\$ 75,000	\$ 75,000	\$ 75,000	\$ 75,000	\$ 75,000	\$ 75,000	\$ 75,000	\$ 75,000	\$ 75,000	\$ 75,000	\$ 75,000	\$ 75,000	\$ 75,000	\$ 75,000	\$ 75,000	\$ 900,000	
Materials (Diesel thru to Closure)	\$CDN	\$ 857,566	\$ 77,961	\$ 77,961	\$ 77,961	\$ 77,961	\$ 77,961	\$ 77,961	\$ 77,961	\$ 77,961	\$ 77,961	\$ 77,961	\$ 77,961	\$ 77,961	\$ 77,961	\$ 77,961	\$ 1,715,131	
G&A (Airfare to site)	\$CDN	\$ 150,000	\$ 150,000	\$ 150,000	\$ 150,000	\$ 150,000	\$ 150,000	\$ 150,000	\$ 150,000	\$ 150,000	\$ 150,000	\$ 150,000	\$ 150,000	\$ 150,000	\$ 150,000	\$ 150,000	\$ 1,800,000	
G&A (Water Monitoring)	\$CDN	\$ 350,000	\$ 350,000	\$ 350,000	\$ 350,000	\$ 350,000	\$ 350,000	\$ 350,000	\$ 350,000	\$ 350,000	\$ 350,000	\$ 350,000	\$ 350,000	\$ 350,000	\$ 350,000	\$ 350,000	\$ 4,200,000	
Lake Refilling and Monitoring Phase Total			\$CDN	\$ 1,754,566	\$ 974,961	\$ 974,961	\$ 974,961	\$ 974,961	\$ 974,961	\$ 974,961	\$ 974,961	\$ 974,961	\$ 974,961	\$ 974,961	\$ 974,961	\$ 974,961	\$ -	\$ 12,479,131
Final Closure Phase				2029	2030	2031	2032	2033	2034	2035	2036	2037	2038	2039	2040	2041	Total	
Labour & Camp/Catering	\$CDN															\$ 600,000	\$ 600,000	
Equipment	\$CDN															\$ 150,000	\$ 150,000	
Materials (na)	\$CDN															\$ -	\$ -	
G&A (Airfare to site)	\$CDN															\$ 100,000	\$ 100,000	
G&A (Airfreight Demob - Hercules)	\$CDN															\$ 700,000	\$ 700,000	
Final Closure Phase Total			\$CDN	\$ -	\$ -	\$ -	\$ -	\$ -	\$ -	\$ -	\$ -	\$ -	\$ -	\$ -	\$ -	\$ 1,550,000	\$ 1,550,000	

21.1.3.2 LAKE REFILLING & MONITORING

Based on the equipment capacities and environmentally acceptable pumping rates, the lake refilling will require approximately 2.5 months per year.

On-site equipment will be required to service the camp, airstrip and remaining roads, and to complete the demolition and demobilization at the final turnover of the project. Service shop and equipment maintenance equipment will also be required at site.

21.1.3.3 FINAL CLOSURE

Final closure will involve decommissioning and demobilising all remaining equipment and facilities on site. The remaining roads will be scarified, and Dyke A will be breached to connect Kennedy Lake back into the watershed. The airstrip and a small temporary camp will remain for subsequent site visits and to allow long-term monitoring/inspections to proceed. Material will be demobilised from site by air.

In addition to the site costs, allowances are provided for ongoing environmental monitoring and consultant work. A summary of the reclamation costs per annum is provided in Table 21.4 above.

21.2 Operating Cost Estimate

21.2.1 INTRODUCTION

The operating cost estimate was developed using first principles and applying direct applicable project experience and avoiding the use of general industry factors. JDS managed and compiled the operating cost estimate and is of the opinion that the costs represent a reasonable and accurate reflection of expected mine operating costs based on the assumption and pricing information available at the time of the Report. The operating cost estimate is grouped by major WBS area as follows:

- Mining
- Processing
- Power Plant
- Freight
- General and Administrative.

The Gahcho Kué diamond mine will represent the sixth diamond mine constructed in Arctic Canada and the fifth diamond mine in the NWT/Nunavut region. Many of the estimate inputs are derived from engineers, contractors, and suppliers who have provided similar services to existing operations and have demonstrated success in executing the plans set forth in the study.

In addition, operating cost estimate inputs were provided by De Beers, based on their experience operating the Snap Lake Mine in the NWT and the Victor mine in Northern Ontario. The operating cost estimates use the labour classification and wage scales currently employed by Snap Lake, and much of the G&A cost estimate details were derived from actual cost data from the Snap Lake mine.

Certain sectors of the operating costs begin during the construction phase (mining, power generation, freight, and G&A) and continue through the life of the mine. All costs incurred during the construction phase have been capitalised and are part of the capital cost estimate.

21.2.2 OPERATING COST SUMMARY

The target accuracy of the operating cost estimate is -5%/+15%, which represents a Feasibility Study Budget/Class 3 Estimate. The average annual operating cost estimate and average LOM unit costs for the Gahcho Kué project are summarised in Table 21.5 in Q3 2013 Canadian dollars.

Table 21.5: Operating Cost Estimate Summary

WBS	Description	Average Annual Cost (\$)	Average Mined (\$/t)	Average Processed (\$/t)
A	Mine	98,505,321	3.49	33.24
B	Process	22,118,252	0.78	7.46
C	Power	17,886,381	0.63	6.04
D	Freight	18,646,525	0.66	6.29
E	G&A	41,701,193	1.48	14.07
F	Contingency	7,198,648	0.26	2.43
G	Management Fee	6,361,794	0.23	2.15
-	Total	212,418,114	7.54	71.68

Note: Unit costs per tonne mined are presented against materials mined in the operational phase only. Cleaning/Sorting cost at \$0.546/ct is in addition to the \$71.68/t processed ($71.68 + 0.83 = \$72.51/ t$ processed).

A summary of operating costs is shown by year in Table 21.6 and in Figures 21-1 and 21-2 (unit costs).

Table 21.6: Summary of Operating Costs, by Year

Total by Activity	Unit	2016	2017	2018	2019	2020	2021	2022	2023	2024	2025	2026	2027	2028	Total
Mining	C\$ (M)	32.2	108.4	116.1	112.9	104.5	118.3	107.9	109.2	110.9	85.2	64.7	56.0	39.2	1,165.6
Processing	C\$ (M)	5.6	21.3	21.6	21.9	22.3	22.5	22.5	22.5	22.5	22.5	22.5	22.1	12.1	261.7
Power Plant	C\$ (M)	4.1	17.5	17.7	17.7	17.7	17.7	17.7	17.7	17.7	17.7	17.7	17.7	13.5	211.7
Freight	C\$ (M)	4.4	18.7	18.9	18.7	18.8	18.9	18.8	18.7	19.0	17.9	17.2	16.7	13.8	220.7
General & Administration	C\$ (M)	13.2	40.3	40.5	40.6	40.7	40.8	40.8	40.9	41.0	40.8	40.8	36.8	36.1	493.5
Contingency	C\$ (M)	2.2	7.5	7.8	7.7	7.4	7.9	7.5	7.6	7.6	6.7	5.9	5.4	4.2	85.2
Management Fee	C\$ (M)	1.9	6.9	7.1	6.7	6.5	6.9	6.7	6.6	6.7	5.8	5.2	4.7	3.6	75.3
Total	C\$ (M)	63.6	220.5	229.8	226.2	218.0	232.9	221.9	223.0	225.4	196.6	173.8	159.3	122.5	2,513.6
Mining	\$/t mined	2.63	2.77	3.03	3.65	3.10	3.55	3.58	3.15	2.86	3.82	5.73	8.00	24.22	3.49
Processing	\$/t mined	0.46	0.54	0.56	0.71	0.66	0.67	0.75	0.65	0.58	1.01	1.99	3.15	7.46	0.78
Power Plant	\$/t mined	0.34	0.45	0.46	0.57	0.53	0.53	0.59	0.51	0.46	0.79	1.56	2.52	8.31	0.63
Freight	\$/t mined	0.36	0.48	0.49	0.60	0.56	0.57	0.62	0.54	0.49	0.81	1.52	2.39	8.54	0.66
General & Administration	\$/t mined	1.08	1.03	1.06	1.31	1.21	1.22	1.35	1.18	1.06	1.83	3.61	5.26	22.30	1.48
Contingency	\$/t mined	0.18	0.19	0.20	0.25	0.22	0.24	0.25	0.22	0.20	0.30	0.52	0.77	2.56	0.26
Management Fee	\$/t mined	0.15	0.18	0.19	0.22	0.19	0.21	0.22	0.19	0.17	0.26	0.46	0.67	2.24	0.23
Total	\$/t mined	5.19	5.63	6.00	7.31	6.47	6.98	7.36	6.43	5.81	8.82	15.38	22.77	75.64	7.54
Mining	\$/t processed	80.52	36.13	38.71	37.65	34.85	39.42	35.97	36.39	36.98	28.41	21.57	18.65	23.55	33.24
Processing	\$/t processed	14.03	7.10	7.20	7.30	7.44	7.49	7.49	7.49	7.49	7.49	7.49	7.35	7.25	7.46
Power Plant	\$/t processed	10.36	5.82	5.88	5.88	5.90	5.88	5.88	5.88	5.90	5.88	5.88	5.88	8.08	6.04
Freight	\$/t processed	11.12	6.25	6.31	6.23	6.27	6.30	6.26	6.23	6.32	5.98	5.72	5.57	8.31	6.29
General & Administration	\$/t processed	33.02	13.45	13.51	13.54	13.58	13.59	13.61	13.63	13.66	13.60	13.59	12.27	21.69	14.07
Contingency	\$/t processed	5.40	2.49	2.59	2.56	2.46	2.63	2.51	2.52	2.55	2.22	1.96	1.80	2.49	2.43
Management Fee	\$/t processed	4.63	2.29	2.38	2.25	2.18	2.31	2.23	2.19	2.22	1.95	1.72	1.56	2.18	2.15
Total	\$/t processed	159.09	73.52	76.58	75.40	72.68	77.63	73.96	74.34	75.12	65.55	57.95	53.09	73.55	71.68

Figure 21-1: Summary of Operating Costs by Year

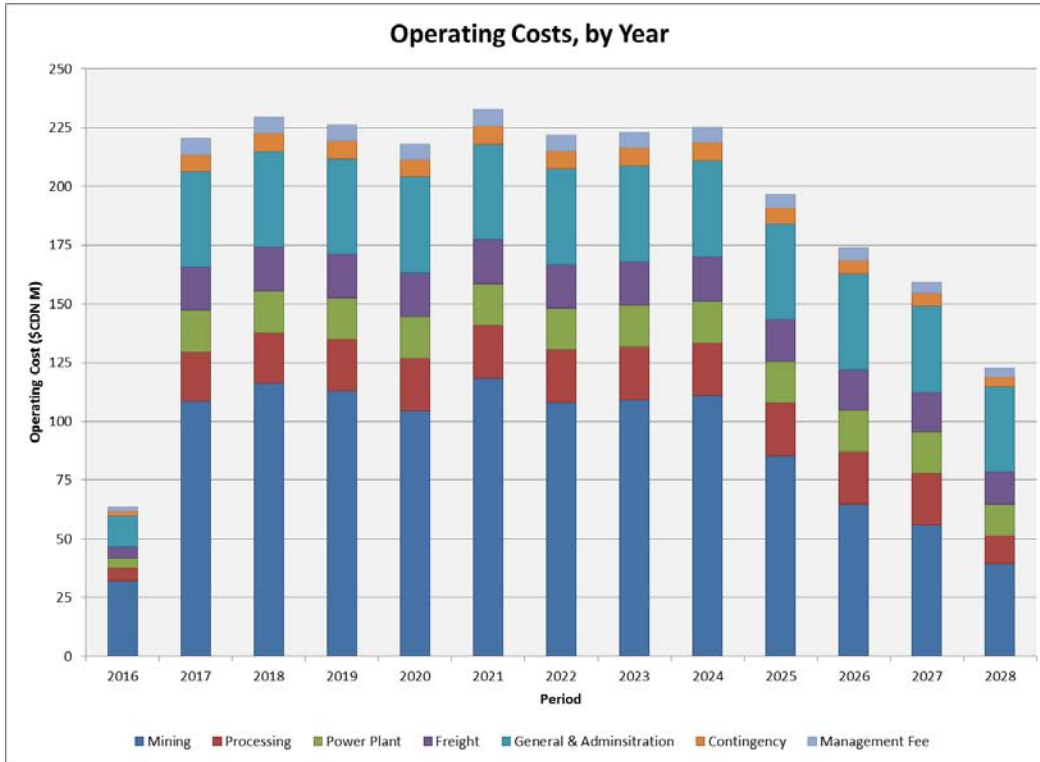

Figure 21-2: Summary of Unit Operating Costs by Year

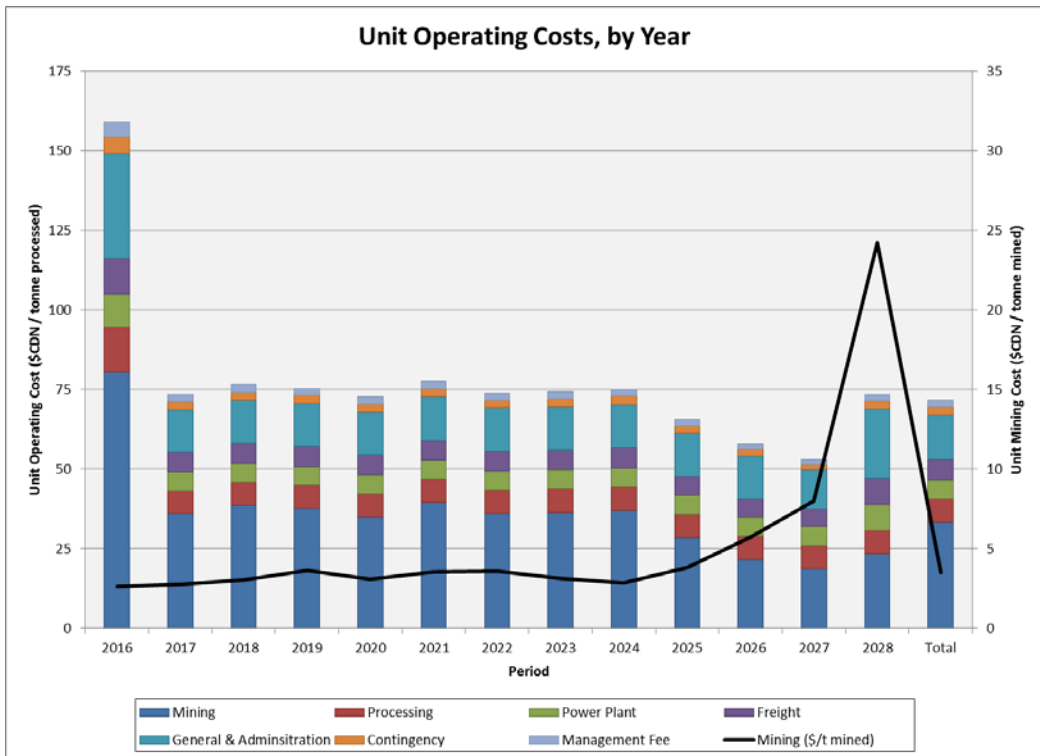
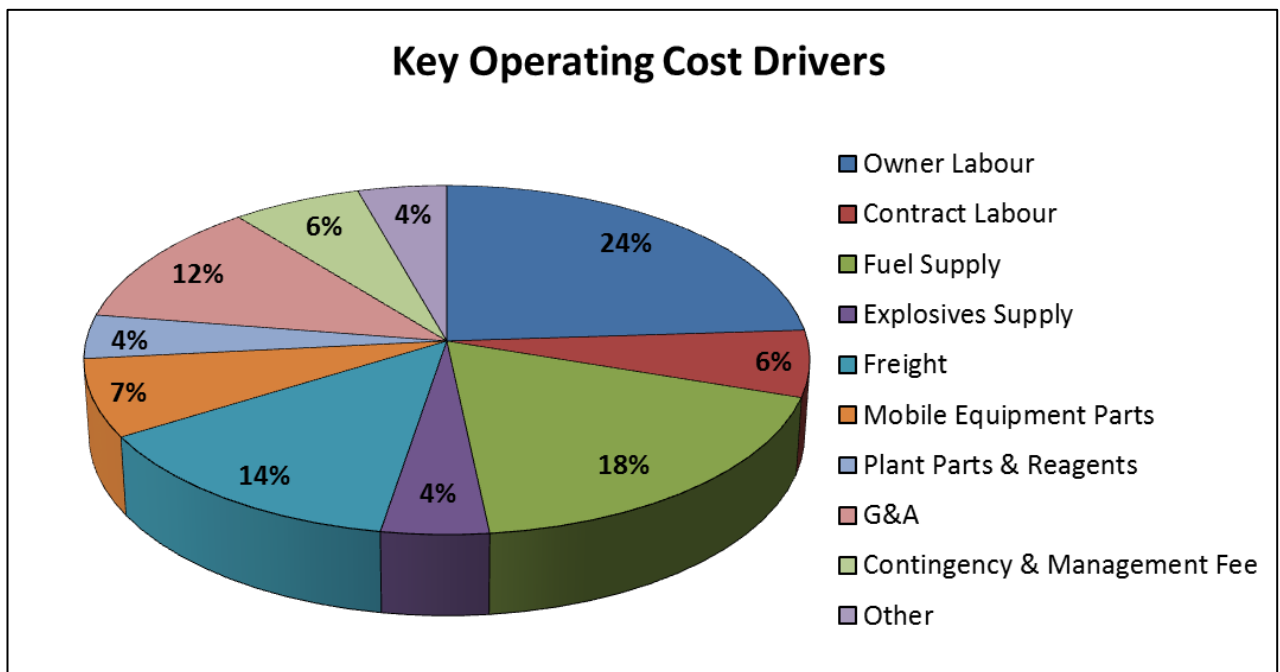

Table 21.7 and Figure 21-3 present a summary of the key operating cost drivers.

Table 21.7: Key Operating Cost Drivers

Functional Area	Average Annual Cost	Average Processed (\$/t)	% of Total
Owner Labour	50,946,240	17.19	24%
Contract Labour	13,059,815	4.41	6%
Fuel Supply	38,607,820	13.03	18%
Explosives Supply	9,182,609	3.10	4%
Freight (all ground & air)	28,823,804	9.73	14%
Mobile Equipment Parts	15,271,515	5.15	7%
Plant Parts & Reagents	8,633,439	2.91	4%
G&A	24,994,974	8.43	12%
Contingency & Management Fee	13,560,442	4.58	6%
Other	9,337,456	3.15	4%
Total	212,418,114	71.68	100%

Figure 21-3: Key Operating Cost Drivers



Operational labour costs (Owner and permanent contract labour) account for approximately 30% of the overall operating costs.

The basis for key operating cost components are as follows:

- Labour rates for all works for the DBCI operations workforce are based on established wage scales used at De Beers' Snap Lake mine in the NWT.
- Wages, benefits, and burdens (both statutory and non-statutory) for all DBCI mine staff are based on the wage scales currently used by DBCI at the Snap Lake mine. Wage packages include allowances for base wages; scheduled overtime; all employment taxes including Unemployment Insurance, CPP, and Worker Compensation; DBCI medical/dental plans; northern living allowances (where applicable) or flight allowances; and additional payments for extra travel time.
- DBCI staff wages are based on a banded Job Class system. Actual wage rates are dependent on the Job Class, shift rotation schedule, and origin location of the employee (Northern or Southern hire).
- Fuel supply prices are based on quotes for current DBCI rack rates
- Fuel delivery costs are in addition to this (as part of freight) and are based on a competitive bid proposal, which includes line haul costs, fuel surcharges, and bridge toll fees.
- Third-party operational service contract costs are largely based on competitively bid quotations specific to the Gahcho Kué site.
- Spare parts and consumables are based on engineering and vendor estimates of consumption rates and secured pricing from selected suppliers.

Certain G&A and other miscellaneous cost estimates are comparable/factored estimates based on realised actual costs at other similar DBCI operations (Victor and Snap Lake).

21.2.3 MAJOR WBS AREAS

21.2.3.1 MINING OPERATING COSTS

The mine operating costs are broken down into the following functional areas:

- Supervision – Includes all mining supervision.
- Drill and Blast – Costs associated with drilling and blasting all waste and ore.
- Load and Haul – Costs related to loading and hauling all waste, ore and coarse processed kimberlite material.
- Site Services – Costs for all mine and site support mine functions, including facility maintenance personnel.
- Mine Maintenance – Costs to maintain and repair the mining and site services equipment.

Annual mining operating costs average approximately \$99 M for the 12-year mine life, or \$3.49 per tonne of material mined. Table 21.8 presents the mining operating cost summary, by functional area.

Table 21.8: Mining Operating Cost Summary, by Area

Functional Area	Average Annual Cost	Average Mined (\$/t)	% of Total
Supervision	1,949,435	0.07	2.0%
Drill & Blast	25,138,942	0.89	25.5%
Load & Haul	49,432,261	1.75	50.2%
Site Services	9,799,094	0.35	9.9%
Mine Maintenance	12,185,589	0.43	12.4%
Total	98,505,321	3.49	100.0%

In contrast to the other operating cost areas, annual mining costs are moderately variable through the mine life, commensurate with the mine plan requirements. The variations are mostly encountered in the load and haul costs, related to progressions in haulage profiles and the different strip ratios encountered in each period.

Key cost drivers for mining operating costs are labour and diesel fuel, comprising over 60% of the total unit cost. Table 21.9 and Figure 21-4 present the mining operating cost, by cost package.

Table 21.9: Mining Operating Cost Summary, by Cost Package

Cost Driver	Average Annual Cost	Average Mined (\$/tonne)	% of Total
Labour	33,383,931	1.18	33.9%
Fuel Supply & Delivery	28,181,171	1.00	28.6%
Parts	15,028,649	0.53	15.3%
Explosives Supply & Delivery	13,804,898	0.49	14.0%
GET & Drill Tooling	3,629,068	0.13	3.7%
Tires	1,835,153	0.07	1.9%
Oil & Lube	1,673,243	0.06	1.7%
Other Items	969,208	0.03	1.0%
Total	98,505,321	3.49	100.0%

Figure 21-4: Mining Unit Operating Costs, by Cost Package

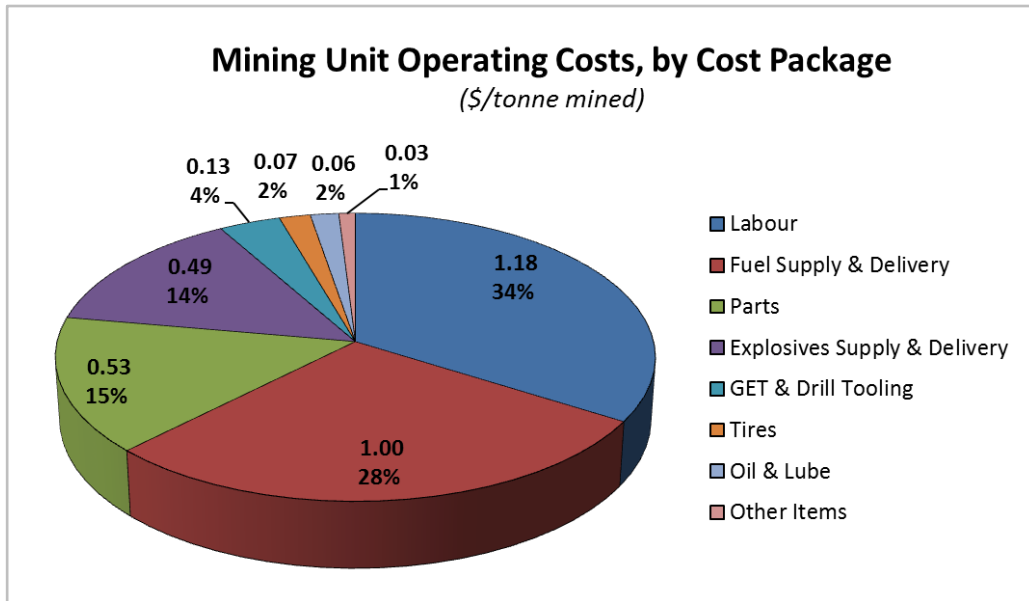

21.2.3.2 PROCESSING OPERATING COSTS

The processing operating costs are broken down into the following functional areas:

- Labour – Includes supervision & technical staff, process plant operators, and process plant maintenance personnel.
- Reagents – Costs for the supply of process plant reagents (primarily Ferrosilicon).
- Mechanical & Piping – Costs for mechanical parts and consumables required for the operation and maintenance of plant equipment.
- Electrical & Instrumentation – Costs for materials and consumables related to electrical and instrumentation systems.
- Plant General – Costs specific to the process plant, but not directly attributable to any of the areas above.

Annual processing costs average approximately \$22 M for the 12-year mine life, or \$7.46 per tonne of material processed. Table 21.10 and Figure 21-5 present a summary of the process plant operating costs.

Table 21.10: Process Plant Operating Cost Summary

Functional Area	Average Annual Cost	Average Processed (\$/t)	% of Total
Labour	12,969,722	4.38	58.6%
Reagents	2,124,119	0.72	9.6%
Mechanical & Piping	5,702,306	1.92	25.8%
Electrical & Instrumentation	634,451	0.21	2.9%
Plant General	687,654	0.23	3.1%
Total	22,118,252	7.46	100.0%

Figure 21-5: Process Plant Unit Operating Costs

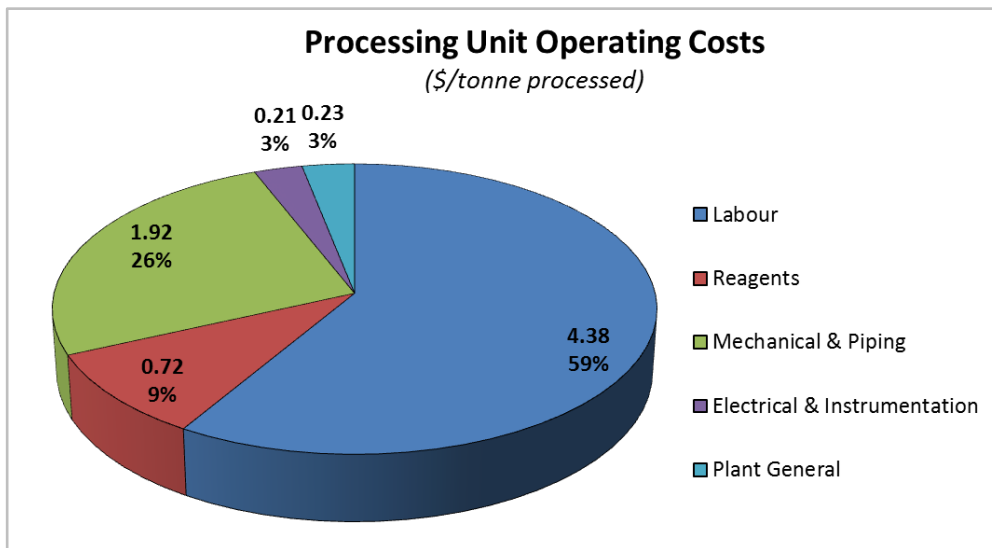

Exclusions

Power generation costs to operate the process plant are included in the power plant operating costs, of which 77% (or \$4.65/tonne processed) is attributable to operation of the process plant.

Cleaning/Sorting cost at \$0.546/ct is in addition to the \$71.68/t processed: $71.68 + 0.83 = \$72.51/ t$ processed.

21.2.3.3 POWER PLANT OPERATING COSTS

The power plant operating costs are broken down into the following cost centres:

- Fuel – costs for the supply and delivery of bulk diesel fuel to operate the power plant.
- Contract Preventative Maintenance (PM) Labour – Costs for a contract technician to perform preventative maintenance and ad-hoc troubleshooting.

- Oil & Lube – Costs related to the consumption of non-diesel fluids
- Parts – Parts costs for the performance of preventative maintenance.

21.2.3.4 SUMMARY

Annual power plant operating costs average approximately \$18 M for the 12-year mine life, or \$6.04 per tonne of material processed. Table 21.11 and Figure 21-6 present a summary of the power plant operating costs.

Table 21.11: Power Plant Operating Cost Summary

Functional Area	Average Annual Cost	Average \$/t processed	% of Total
Fuel Supply & Delivery	17,076,159	5.76	95.5%
Contract PM Maintenance Labour	431,091	0.15	2.4%
Oil & Lube	136,263	0.05	0.8%
Parts	242,867	0.08	1.4%
Total	17,886,381	6.04	100.0%

Figure 21-6: Power Plant Unit Operating Costs

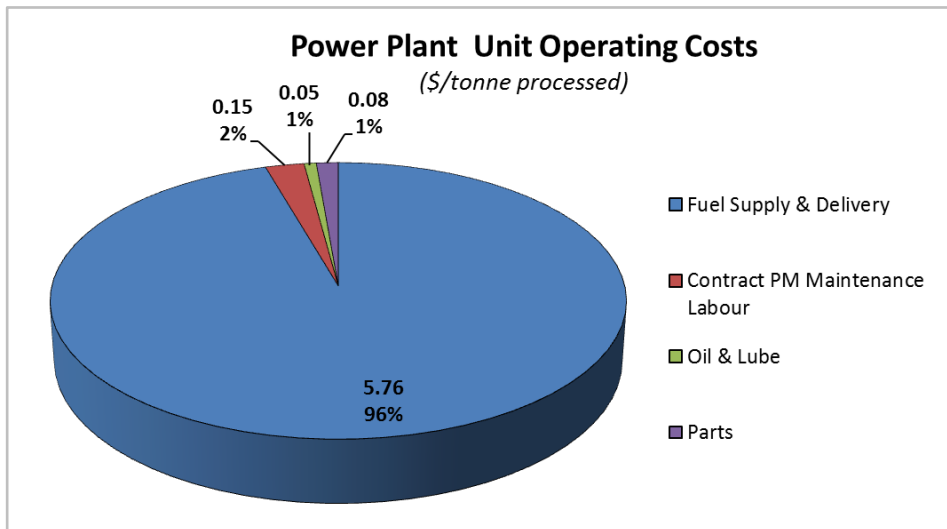

21.2.3.5 FREIGHT OPERATING COSTS

The operating costs for freight have been grouped into the following areas:

- Ground Freight – costs related to the ground transportation of cargo (excluding fuel and explosives).

- Tibbett-to-Contwoyto Winter Road Fees – Cost incurred by the project through the use of the TCWR.
- Winter Spur Road Construction & Maintenance – Costs related to the construction and operation of the Gahcho Kué winter spur road.
- Air Freight & Helicopter Support – Costs for contract air freight and helicopter support.
- Contract Passenger Air – Costs to transport personnel to and from the GK site from Yellowknife and surrounding communities.

21.2.3.6 SUMMARY OF FREIGHT COSTS

Annual freight costs average approximately \$19 M for the 12-year mine life, or \$6.29 per tonne of material processed. Table 21.12 and Figure 21-7 present a summary of the freight costs.

Table 21.12: Freight Operating Cost Summary

Functional Area	Average Annual Cost	Average \$/t processed	% of Total
Ground Freight (Cargo)	4,873,804	1.64	26.1%
TC Winter Road Fees	3,627,509	1.22	19.5%
Winter Spur Road Construction & Maintenance	1,976,029	0.67	10.6%
Air Freight & Helicopter Support	2,784,955	0.94	14.9%
Contract & Commercial Passenger Air	5,384,227	1.82	28.9%
Total	18,646,525	6.29	100.0%

Figure 21-7: Freight Unit Operating Costs

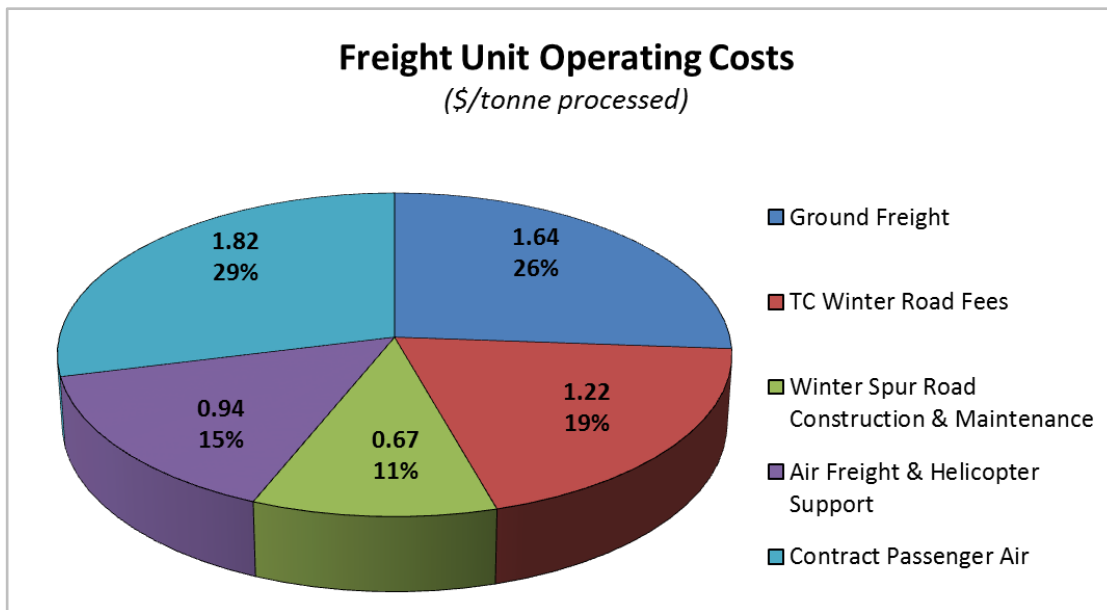

Exclusions

Over 90% of the trucking requirements during operations will be associated with the transport of diesel fuel and bulk ammonium nitrate, both of which have the freight charge component included in the commodity rates. As such, these costs are captured in the mining and power plant operating cost sections.

21.2.3.7 G&A OPERATING COSTS

General and administrative costs have been grouped into the following areas:

- G&A Labour – Labour costs for site employees in the following categories:
 - Technical Services
 - Mine Management
 - Safety, Health, and Environment
 - Protective Services
 - Purchasing & Logistics
 - HR & Training
 - Mine Finance
- G&A Items – On-site – Costs for materials, contractors, licenses, and fees related to the project site but not attributable to any of the other operating cost areas.
- G&A Labour – Off-site – Labour costs for employees working from the Yellowknife office.
- G&A Items – Off-site – General off site costs related to the operation, such as legal fees and off-site business travel. Includes costs to operate the Yellowknife office.

Annual G&A costs average approximately \$42 M for the 12-year mine life, or \$14.07 per tonne of material processed.

Table 21.13 and Figure 21-8 present a summary of the G&A costs.

G&A cost allocation for a typical year (2020) are shown in Table 21.14.

Table 21.13: Freight Operating Cost Summary

Functional Area	Average Annual Cost	Average \$/t processed	% of Total
Labour – On-site	14,991,713	5.06	36.0%
G&A Items – On-site	23,665,137	7.99	56.7%
Labour – Off-site	1,714,506	0.58	4.1%
Items – Off-site	1,329,837	0.45	3.2%
Total	41,701,193	14.07	100.0%

Figure 21-8: G&A Unit Operating Costs

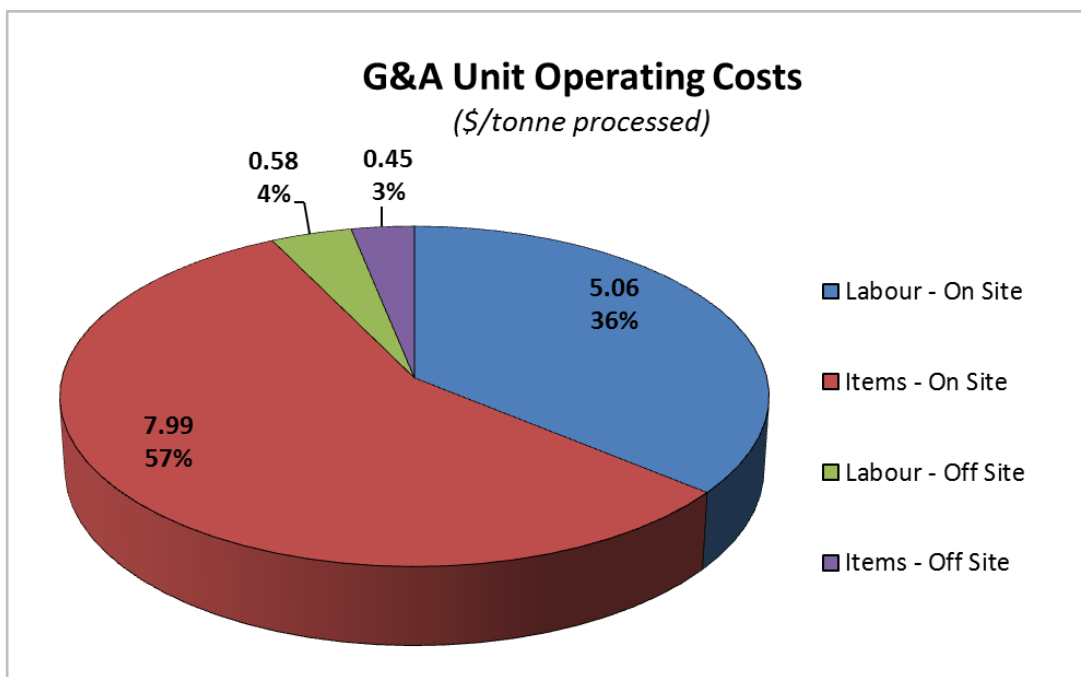

Table 21.14: G&A – Allocation of Annual Operating Costs

Cost Group / Item	% of Total
G&A Owner Labour - On-site	
Technical Services	2%
Engineering	4%
Geology	4%
Mine Management	3%
SHE	6%
Protective Services	7%
Purchasing & Logistics	7%
HR & Training	4%
Finance	0%
Total - On-site G&A Owner Labour	35%
G&A Items - On-site	
Camp Catering & Cleaning (includes Labour)	13%
Medical Services (includes Labour)	1%
Office Supplies	0%
IT & Satellite Communication	5%
Insurance	3%
Property Tax Estimate	9%
Personal Protective Equipment	0%
Safety Materials & Awards	1%
Fees, Licensing, & Leases	0%
IBAs & Related Expenses	8%
External & Corporate Affairs	4%
Camp Maintenance (Materials)	1%
Environmental Consultants & Monitoring	9%
Environmental Bond/Letter-of-Credit	1%
General Consultants	2%
Mobile Phones - Supervisors	0%
Technical Services - Non-Labour	0%
Total - On-site G&A Items	58%
G&A Owner Labour - Off-site	
YK Office Labour	3%
Total - Off-site G&A Owner Labour	3%
G&A Items - Off-site	
YK Office	1%
SHE Administrative Expenses	0%
Legal	0%
Off-site Business Travel	1%
Secure shipping of Diamonds	0%
Mobile Phones - Supervisors	0%
Total - Off-site G&A Items	3%
Grand Total	100%

21.2.3.8 OPERATING COST CONTINGENCY

A cost contingency of 3.62% has been applied to the operating costs, based on a qualitative risk analysis of key cost drivers, and their risk for quantity or pricing variations.

A workshop was held with key members of the EPCM and DBCI project team, where costs were logically grouped by type and values were ranged for the P10 and P90 cases for both quantity and unit price.

@RISK was used to model the risk profile using PERT distribution curves and Monte-Carlo sampling (5000 iterations). Fuel price and labour quantity were determined as the key contingency contributors. A 65% confidence was chosen, which equates to a 3.62% contingency on operating costs.

21.2.3.9 DBCI MANAGEMENT FEE (CORPORATE CHARGES)

Within the JV agreement, there is an option to contract work to any person associated or affiliated with a participant in the JV agreement, provided such work is done at prices that are competitive in the market place and no partner shall profit from the services. Provided there is agreement between the JV partners that a service is essential to the operation and that the cost is competitive, then corporate services (e.g., finance) that are not included elsewhere would fall under this cost category.

A management fee of 3% has been applied to the sum of the post contingency operating costs and the sustaining capital costs. This equates to an average annual cost of \$6.3 million or \$2.15 per tonne processed and was benchmarked against corporate charges.

21.2.3.10 OFF-SITE NET REVENUE COSTS

These items are closely associated with revenue conversion and are sometimes found in G&A operating costs. However, for the purposes of this estimate, they have been included elsewhere within the financial evaluation.

21.2.3.11 MARKETING FEE

No additional marketing fees are included.

21.2.3.12 DIAMOND CLEANING & SORTING

Sorting and cleaning costs are included separately within the economic analysis and are calculated at a rate of \$0.55/carat, which is equivalent to \$0.83/tonne processed.

SECTION 22 ECONOMIC ANALYSIS

22.1 Summary

JDS managed and compiled the economic analysis and is of the opinion that it is a reasonable and accurate reflection of the project's economic performance based on the assumptions and information available at the time of the Report.

The financial evaluation of the project has been undertaken on an after-tax, unleveraged, real rate of return to the JV partners as a whole and does not reflect the tax structure of the individual partners or the marketing strategies or any related marketing sales expenses/profits beyond the sale/allocation of diamonds to each partner at the time of valuation. The analyses assumed that three kimberlite ore bodies will be developed, with production on the first pipe (5034) starting in mid-September 2016 as part of the scheduled plant ramp up. Production, including ramp up, extends over roughly 12 years. All production, costs, and revenues are based on calendar fiscal years.

The project is economically viable and provides a real rate of return to the partners of 32.6% and a real net present value (NPV) at 10% of C\$1,004.8 million in calendar 2013 Canadian dollars, excluding sunk costs. In the scenario of including sunk costs incurred to end of 2013, the project provides a real rate of return of 21.9% and a real NPV at 10% of C\$747.3 million. In the sunk cost excluded scenario, the project is most sensitive to changes in diamond prices, with real dollar returns decreasing the IRR by 4.5% for a 10% reduction in prices and increasing the IRR by 4.2% for a 10% increase in prices. The project shows a lesser sensitivity to capital with IRR figure changing by +3.1%/-2.7% for a $\pm 10\%$ change in capital. The sensitivity to operating cost is $\pm 1.4\%$ for a $\pm 10\%$ change in the IRR rate for a 10% in operating costs.

Table 22.1 provides a summary of selected financial inputs and the corresponding results. All costs are quoted in Q3 2013 Canadian dollars.

The Gahcho Kué project is a joint venture. All of the numbers presented in this financial section for the are based upon 100% ownership and include JV management fees (in Opex), but no financing costs that are payable between the joint venture partners. Furthermore, the project is evaluated on a 100% equity basis only, and excludes any financial leveraging effects, as well as any interest expense items that could impact taxable income and/or provide interest deduction tax shields. The analysis uses diamond pricing from WWW International Diamond Consultants Ltd., (WWW).

- The analysis is based on an open pit mining operation with a processing throughput of 3.0 Mt/a using probable reserves with dilution by limited additional mill feed material (at zero grade) and is based on a nominal 1.00 mm cut-off size for the processing plant.
- An analysis including and excluding (prior to 2013) sunk costs has been completed.

This financial analysis is based on mineral resources, with the objective of demonstrating economic viability. The Gahcho Kué 2014 Feasibility Study Report was completed to provide an updated assessment of the Gahcho Kué Project and incorporates additional resource information; design modifications; permitting timeline updates; revisions to the project execution strategy and current diamond pricing information since the 2010 FS. The Gahcho Kué 2014 Feasibility Study Report was intended to support project financing activities and the JV partners formal decisions to proceed with the detail design and construction phases (conditional upon issuance of final permits). The feasibility study also demonstrates adequate economic viability of mineral resources that are sufficiently defined geologically to enable them to be categorised as mineral reserves.

Table 22.1: Financial Model Inputs & Results

Description	3.0 Mt/a Case
Material Processed – Annual (Mt)	3.0
Material Processed – Life of mine (Mt)	35.1
Sunk Costs Exploration and Development pre-July 2009 (\$ million)	120.0
Sunk Costs Feasibility Study and Permitting– 2009-2010 (\$ million)	20.9
Sunk Costs EIS, FEL3 & FEL4, Permitting– 2011-2013 (\$ million)	118.6
Balance of Initial Project Capital – 2014 to 2017 (\$ million)	858.5
Working Capital (2016 at 25.7 and 2017 at 54.4) (\$ million)	80.1
Sustaining Capital including Mine Closure (\$ million)	92.7
Operating Costs – Average over life of mine (\$/t processed) including sorting	72.51
Real Diamond Price Escalation – 2014 forward (%/a) [amount over US CPI]	1.5
Projected Plant Life (years)	11.7
Processing Diamond Cut-off Size (mm)	1.0
Inflation used for Escalation/De-escalation – (%/a)	1.48
Total Carats Recovered (M)	53.4
Diamond Price (RV LOM Escalated, US\$/ct)	149.66
Diamond Price (RV LOM Un-Escalated, US\$/ct)	118.38
Project IRR – Sunk costs not included (%)	32.6
NPV @ 10% – Sunk costs not included (\$ million)	1,004.8
Project IRR – Including sunk costs (%)	21.9
NPV @ 10% – Including sunk costs (\$ million)	747.3

22.2 Assumptions & Evaluation Methodology

22.2.1 EVALUATION METHODOLOGY

The financial evaluation has been performed using the escalate/de-escalate methodology, whereby all cash inflows and outflows are escalated by an appropriate index, then subsequently de-escalated at the inflation rate to determine NPV and IRR. This allows for adjustments to the unescalated model to reflect differential escalation rates and appropriate application of tax pools, which must be applied against escalated profits.

The July 2009 revised JV Agreement guides the methodology for project evaluation, as well as, the source, determination, and handling of key parameters. In summary, Schedule B of the JV Agreement outlines the following:

- Evaluation based on after-tax unleveraged, real internal rate of return (IRR) using end-of-year convention for cash flows in Canadian dollars.
- Estimate for future inflation, based on a five-year average of annual change to the CPI (consumer price index) on an All Items, Not Seasonally Adjusted, Annual Averages basis.
- Five-year average refers to five calendar years prior.
- CPI for Canada from Statistics Canada.
- CPI for US from official US statistics.
- Exchange rate for CAD/US dollars in the economic evaluation is based on average for 30 business days prior to the delivery of the feasibility study for the initial rate, which is then annually adjusted according to the ratio of compounded CAD and US CPI values.
- Diamond prices may vary differently from either CPI; the JV Partners will determine the diamond price escalation to be used. The steps to calculate/convert revenue are US dollar value calculation for carats produced and sold in a year; conversion to Canadian dollars; calculation of the Canadian dollar de-escalated value by removing Canadian inflation.
- Total actual historic JV expenses to be included in the evaluation at the start year:
 - C\$120 million (sunk) (an additional C\$64 million of pre-2009 sunk costs is excluded from all aspects of the analysis)
 - Grossed-up funded expenses
 - Other JV expenses (from date of agreement to approval of the construction program).

Economic Analysis exceptions to Schedule B guidance includes:

- Diamond prices in US\$/ct are based on WWW valuation provided to MPV and no additional marketing fee overhead.
- Working capital has been updated in the Gahcho Kué 2014 Feasibility Study Report. The methodology and figures described in Section 22.5.3 are applied in the model as being more representative of the detail now available.

22.2.2 ESCALATION & EXCHANGE RATES METHODOLOGY

Average annual index details used in the prescribed method of calculating the CPI values are in Table 22.2 for both Canadian and US dollars CPI calculations.

Table 22.2: Basis for Five-year CPI

Year	Canada		US	
	Average Annual Index	% Change	Average Annual Index	% Change
2008	114.1	-	215.3	-
2009	114.4	2.33%	214.5	3.84%
2010	116.5	0.26%	218.1	-0.36%
2011	119.9	1.84%	224.9	1.64%
2012	121.7	2.92%	229.6	3.16%
2013	122.8	1.50%	233.0	2.07%
Average	-	1.48%	-	1.60%

All operating costs are assumed to rise at 1.48% per year, which is the same as Canadian CPI average for the past five years. All capital costs are assumed to rise at 3.0% per year, which was adopted as part of the Clarification Report to the 2010 Feasibility Study in establishing the JVAC (Joint Venture Approval Case), and is an escalation rate that has been demonstrated to be reasonable at current and anticipated market conditions. There are exceptions to escalation during the construction period in that with near and long-term known prices and the timing of price increases from some secured vendors not always at the end of a calendar year, an escalation profile generated in the Capital Estimate has been applied in the economic model.

Revenues (diamond prices) are based in US dollars. Diamond prices are assumed to escalate at a 1.5% real growth rate over the US CPI inflation. The real diamond escalation rate was based on the JV projected supply/demand curve for diamonds, which for the purpose of the feasibility study, was determined to be 1.5% (over US CPI @ 1.60%) from 2015 onward (2014 prices).

The exchange rate for the CAD/US dollar in the economic valuation is based on the average for 30 business days, which, as of 26 March 2014, is 1.109:1.000. This is the rate applied in the financial analysis. The exchange rate is adjusted annually according to the ratio of the compounded Canadian and US CPI values. Under the base case scenario, the Canadian dollar strengthens slightly from a 1.109:1.00 rate in 2014 to a 1.091:1.00 value in the last year of production.

22.2.3 BASE DATE

The base date for escalation, NPV, and IRR calculations for the financial model is 2013. All cash inflows and outflows, as per Schedule B, are assumed to occur at the end of each year (“end-of-year convention”).

22.3 Sunk Costs

In July 2009, the JV partners revised their agreement for the Gahcho Kué property. The total actual historic JV expenses prior to July 2009 are C\$184 million. The JV partners have agreed that the amount of this expenditure to be included in the financial analysis will be (as defined in Schedule B) included in the evaluation at the start year:

- C\$120 million (sunk)
- grossed-up funded expenses
- other JV expenses (from date of JV agreement to approval of the construction program).

The total pre-July 2009 sunk costs, including all project expenditure since the inception of the initial JV agreement in 1997, were used to determine additional shared tax pool credits. These include JV prospecting, exploration and development through 2002; the 2000 Desktop Study; the 2002 Desktop Study Update; 2003 Geotechnical Drilling Program; 2004/2005 Study and Drilling Program; 2005/6 Drilling Program; and the 2007 Drilling and Permitting program up to the revised and amended JV agreement of July 2009. The agreed-upon amount per the JV agreement is C\$120 million.

Sunk costs since July 2009 to the end of 2010 include grossed-up funded expenses and other joint venture expenditures for the feasibility study, project management services, preparation of the EIS and other permitting activities. The compiled expenses total C\$20.9 million for this period. Following completion of the 2010, the sunk costs for the 2011-2013 calendar years are listed below. These costs were provided by DBCI in early 2014.

• 2011	C\$11.83 million
• 2012	C\$18.61 million
• 2013	C\$88.13 million
• Total	C\$118.57 million

Costs associated with De Beers entering into the JV, including equity purchases and gains on warrants, are not included for valuation purposes. Likewise, payments between the JV partners for fees, carried interests, and other financing provision are not included in the CAPEX.

22.4 Revenue

Mine revenue is derived from the sale of diamonds into the international market place. Joint venture partners are responsible for marketing their respective share of the production. Revenues (RV) are calculated by using the carat value obtained from a valuation source (WWW) as the diamond value accrued to the project. The annual estimate of the revenue per carat varies in accordance with the changing geological nature and relative diamond values estimated for the deposits.

22.4.1 DIAMOND VALUES

Diamond values were determined from a 2014 WWW valuation based on their February 2014 price references (Non-public Report: *Re-Price & Modelling of the Average Price of Diamonds from the Gahcho Kué Diamond Project – February 2014*). This valuation is summarised in Table 22.3. The base 2014 input diamond prices in US\$/ct for the different pits and zones are shown below.

Table 22.3: WWW Valuation (2014)

Pit (and zone)	WWW Price
5034-CP	132.00
5034-WP	131.00
5034-NE	142.00
5034-NT	142.00
5034-ST	131.00
Hearne	107.00
Tuzo	101.00

With a base date of 2014, no diamond price escalation is applied in 2014.

22.4.2 3.0 MT/A PRODUCTION & REVENUE SUMMARY

Following commissioning during Q3 2016, production ramp-up is scheduled to start at mid-September 2016 with full commercial production status achieved by end of January 2017, resulting in a full, first year throughput of 3.0 Mt during 2017. Based on the average processing rate of 8,333 t/d for 360 days per year (3.0 Mt/a), the 35.1 Mt kimberlite mill feed will provide for operations through over half of 2028. This translates into a projected plant operational life of roughly 12 years.

Over the life of the mine, 53.4 Mct will be recovered for a total, real dollar gross revenue (RV) of C\$7,720.8 million (nominal value C\$8,780.3 million).

22.4.3 REVENUE INPUTS & ASSUMPTIONS

Revenues are calculated in US dollars and converted to Canadian dollars at an exchange rate based on an initial rate 30 business days prior to the delivery of the feasibility study of 1.109 CAD/USD. This is then annually adjusted according to the ratio of compounded Canadian and US CPI values.

The economic model results in an average RV of US\$149.66/ct (realised value is SSV net of marketing), as shown in Table 22.4. This is equivalent to an SSV (standard sales value) of US\$149.66/ct (same as RV with marketing assumed at no additional cost), which is used in the calculation of territorial tax/royalty.

Table 22.4: Diamond Value by Pit

By Pit	Carats Recovered (million)	Realised Value (RV) Escalated (US\$/ct)	Realised Value (RV) Un- Escalated (2014) (US\$/ct)
5034	23.2	167.35	138.19
Hearne	11.7	123.19	107.00
Tuzo	18.5	144.36	101.00
Avg. (total for carats)	53.4	149.66	118.38

The expected diamond recovery estimates are inclusive of the expected plant recovery factors. The reserve grades are inclusive of expected plant recovery factors as determined through the bulk sampling programs.

22.5 Total Construction Capital Estimate

22.5.1 SUNK COSTS

The financial model assumes the following milestones and associated expenditures:

- Pre-July 2009 expenses for exploration and development of C\$120.0 million.
- July 2009 thru to end of 2010 expenses for permitting, feasibility study, and other development expenses of C\$20.9 million.
- Full calendar years of 2011-2013 covering expenses for EIS, permitting, detailed engineering, EPCM establishment, and other development expenses of C\$118.6 million.

22.5.2 INITIAL CAPITAL COSTS

From 2014 through Q1 2017, the remaining cost of execution will be C\$858.5 million before escalation and excluding Working Capital. The scope of work will encompass finalization of permitting, further site capture detailed engineering, procurement, site construction and commissioning. Note that inclusion of the Sunk Capital for 2011 through 2013 totals C\$977.0 million before escalation and Working Capital and represents the full cost of execution since completion of the 2010 FS.

Note that the cost of operation after the initiation of the mid-September 2016 plant ramp-up has not been capitalised and was treated as an operating cost (refer to Section 22.5.3 for additional details). EPCM closeout costs and similar items are treated as depreciable capital costs. Minor capital costs appearing in Q1 2017 are included in the 2016 capital cost allocation as most can be regarded as commitments occurring in 2016.

22.5.3 WORKING CAPITAL

The working capital is based on the timing of payment for operating costs (supplies) to ensure sufficient site inventories during the transition to commercial production (January 2017) and the

allowance for the resupply of inventories of the ensuing winter road resupply (primarily diesel fuel) during the two month period following sustained commercial production. Working Capital (WC) includes two amounts: C\$25.7 million in 2016 for supplies that remain in inventory prior to the 2017 winter road and C\$54.4 million in 2017, which for resupply totals C\$80.1 million. The working capital is recouped in the final year of mine operations (full dollar amount). The working capital recouped does not benefit from any escalation due to inflation, but does lose value and is not subject to any direct tax treatment.

The Ramp-Up costs are included as Operating Costs in the model, the unescalated amount in 2016 (Sep 2016 to end-Dec 2016) is C\$63.6 million and in 2017 (month of January) is C\$18.3 million, or combined, C\$81.9 million. These costs represent the operating cost during the five-month ramp up period between first ore production and steady state processing operation and exclude any revenues from diamonds recovered.

When escalation is applied to the capital cost, the total capital cost expenditure (excluding sunk costs) for the project, for 2013 to Q1 2017 inclusive, is C\$1,071.0 million, with Working capital and Ramp-Up costs included.

A high-level capital expenditure flow summary is provided in Table 22.5 below.

Table 22.5: Capital & Ramp-up Expenditure Cash Flow

(\$M)	Sunk Costs	Execution ⁽²⁾	Total
2010	140.9	-	140.9
2011	11.8	-	11.7
2012	18.6	-	18.9
2013	88.1	-	88.1
2014	-	184.2	184.2
2015	-	413.4	413.4
2016	-	260.9	260.9
2016 Working Capital	-	25.7	25.7
2017 Working Capital	-	54.4	54.4
2016 Ramp-Up	-	63.6	63.6
2017 Ramp-Up	-	18.3	18.3
Unescalated Total	259.5	1,020.5	1,280.1
Base Capital Cost Escalation ⁽¹⁾	-	42.0	42.0
WC & Ramp-Up Escalation ⁽³⁾	-	8.5	8.5
Escalated Total	259.5	1,071.0	1,330.6

⁽¹⁾ Note that this escalation is based on a calculation outside the economic model and that the model uses that profile for the construction years, otherwise escalation is at single escalation rate (nominally 3.0%). ⁽²⁾ The expenditure profile during construction execution is based on a Cash Flow basis rather than an Incurred or Committed basis. ⁽³⁾ The Working Capital and Ramp-Up costs are escalated at Canadian CPI of 1.48%.

22.5.4 SUSTAINING & MINE CLOSURE CAPITAL

Sustaining (or replacement) capital including mine closure costs is expected to be C\$92.6 million excluding escalation, distributed from 2017 to 2040. The most significant expenditures are for equipment replacement/addition and ongoing dam/dyke construction. Summary is provided in Table 22.6.

Table 22.6: LOM Capital

Description	2013 \$M	Escalated \$M
Sustaining Capital	75.7	94.1
Mine Closure Capital	16.9	31.8
Subtotal	92.6	125.8
Initial Capital – Including sunk WC, and Ramp-Up	1,280.1	1,330.6
Total LOM Capital	1,372.7	1,456.4

Total project capital costs (inclusive of the ramp up operating costs considered as capital) over the LOM are C\$1,372.7 million (C\$1,456.4 million escalated).

22.6 Operating Costs

The total unescalated amount spent on operating costs is C\$2,542.8 million. This translates to an average cost of \$72.51/t processed over the life of the mine. These costs are shown in Table 22.7.

Table 22.7: Operating Costs by Area over Life of Mine – Reserve Case

Area Description (\$/t processed)	3.0 Mt/a Case
Mining	33.24
Processing	7.46
Power Plant	6.04
Freight	6.29
G&A	14.07
Contingency	2.43
Management Fee	2.15
Sub-Total	71.68
Sorting	0.83
Total	72.51

Note: Operating unit costs summaries shown above are inclusive of the ramp up period costs with the exception of sorting.

22.7 Fiscal Parameters & Taxes

22.7.1 FISCAL PARAMETERS

A financial model was used for the purpose of effectively evaluating the project within the terms and conditions of the JV Partner's agreement. An update to current, NWT applicable tax handling, was taken from the then current (April 2010) DBCI tax model. A collaborative review of the capital cost items was completed with DBCI in-house tax specialist to ensure that the various tax pool classifications were allocated correctly. For the Gahcho Kué 2014 Feasibility Study Report and this Technical Report, the same approach was applied.

The significant tax pools available to the project from previous exploration spending in Canada are handled in two ways:

- The JV agreement has a fixed amount of C\$120 million (plus other applicable JV expenses) that is included in the economic evaluation. Although these are sunk costs, they are treated as capital expenditures with relevant tax classes.
- There is an additional amount of C\$64 million that relates to actual JV expenditures, but in excess of the C\$120 million fixed amount. The C\$64 million does not appear in the financial evaluation as a sunk cost.

22.7.2 TAX SUMMARY

The total tax burden amounts to C\$1,420.7 million (unescalated). However, this amount occurs largely in the later years of production (due to the amortization and depreciation benefits in the early years, reducing the impact on an NPV 10% basis to C\$587.4 million.

Taxes include territorial mining tax and federal and territorial income taxes. Two types of taxes, the Large Corporation Tax and the Federal Surtax, which were included in economic evaluations of previous studies, are no longer applicable. Total income and royalty taxes paid by the project on a nominal basis equals C\$1,637.9 million in taxes payable and is shared in the manner shown in Figure 22-1.

Property taxes are based on an estimate by De Beers given their regional experience and is included in G&A. Estimate is deemed to be reasonable.

Figure 22-1: Tax Sharing

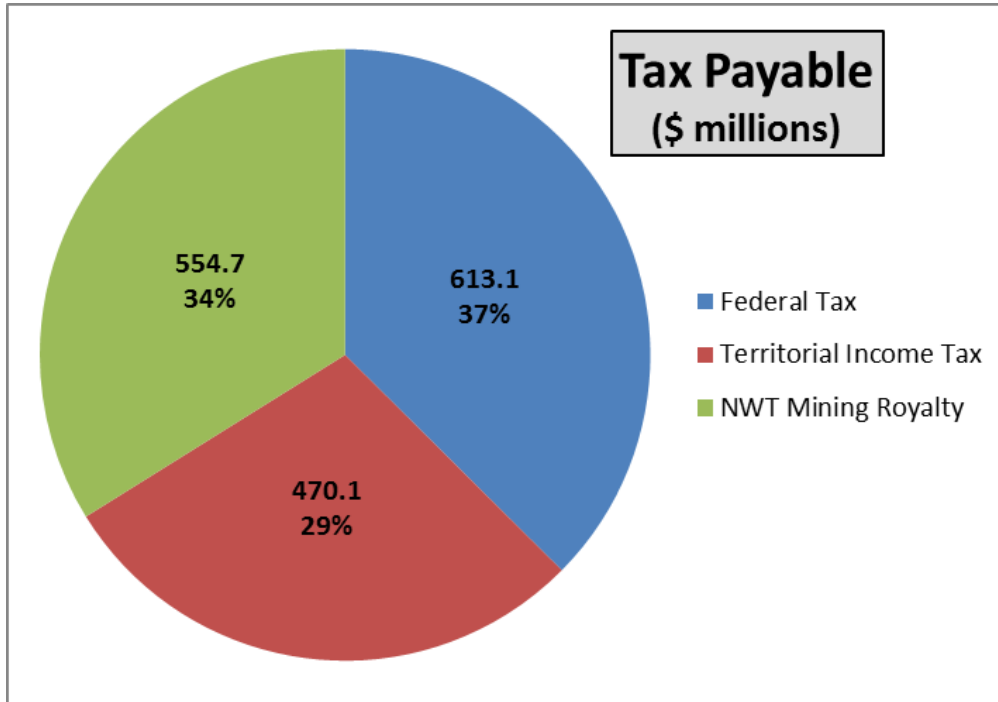

22.8 Net Present Value Summary

The financial analysis detail for the sunk costs excluded scenario is found at the end of this section. The results are summarised below in Tables 22.8 to 22.10.

Table 22.8: Net Present Value Summary (Sunk Costs Excluded)

(Unescalated \$M)	3.0 Mt/a Case	
	Total	NPV @ 10%
Net revenue	7,720.8	3,542.0
Operating costs (incl. reclamation)	(2,542.8)	(1,146.0)
Cash flow from operations	5,178.0	2,396.0
Capital (incl. sustaining capital, working capital, feasibility & permitting)	(992.9)	(803.9)
Profit before taxes	4,185.1	1,592.1
Taxes	(1,420.7)	(587.4)
Net profit	2,764.3	1,004.8
IRR	32.6%	

Table 22.9: Net Present Value Summary (Sunk Costs Included)

(Unescalated \$M)	3.0 Mt/a Case	
	Total	NPV @ 10%
Net revenue	7,720.8	3,542.0
Operating costs (incl. progressive reclamation)	(2,542.8)	(1,146.0)
Cash flow from operations	5,178.0	2,396.0
Capital (incl. sustaining capital, working capital, reclamation, sunk)	(1,252.4)	(1,063.4)
Profit before taxes	3,925.6	1,332.6
Taxes	(1,415.8)	(585.3)
Net profit	2,509.8	747.3
IRR	21.9 %	

Table 22.10: Net Present Value for Various Discount Rates

Discount Rate	NPV (\$M)	
	Excluding \$259.5 million Sunk	Including \$259.5 million Sunk
5%	1,664.0	1,407.7
10%	1004.8	747.3
12%	818.0	560.3
15%	595.0	336.9

22.9 Sensitivity

The sensitivity charts (Figures 22-2 to 22-5) show IRR and NPV@10% variation due to changes in revenue, construction capital, or operating costs, holding all other inputs constant. Scenarios including and excluding sunk costs are provided.

The project clearly is more sensitive to the diamond value parameter.

Figure 22-2: IRR Variation 3.0 Mt/a Case (sunk costs excluded)

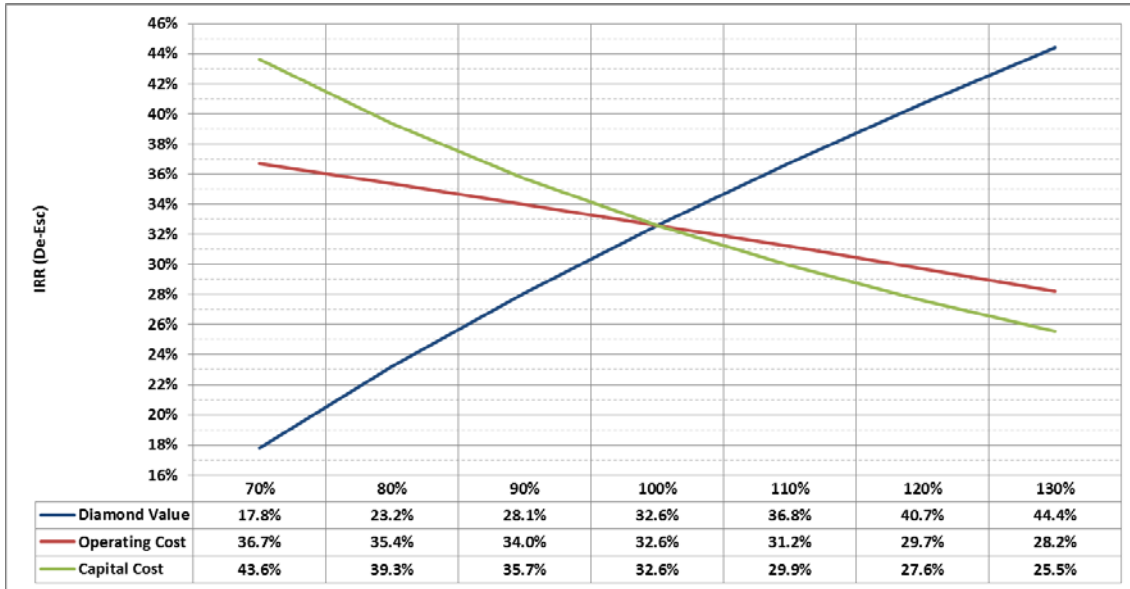

Figure 22-3: NPV Variation 3.0 Mt/a Case (sunk costs excluded)

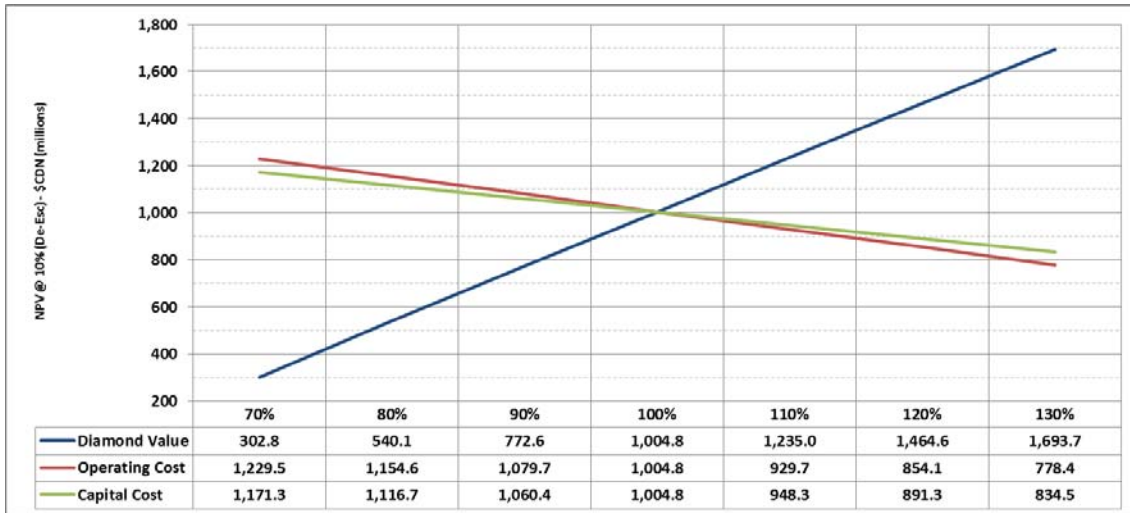

Figure 22-4: IRR Variation 3.0 Mt/a Case (sunk costs included)

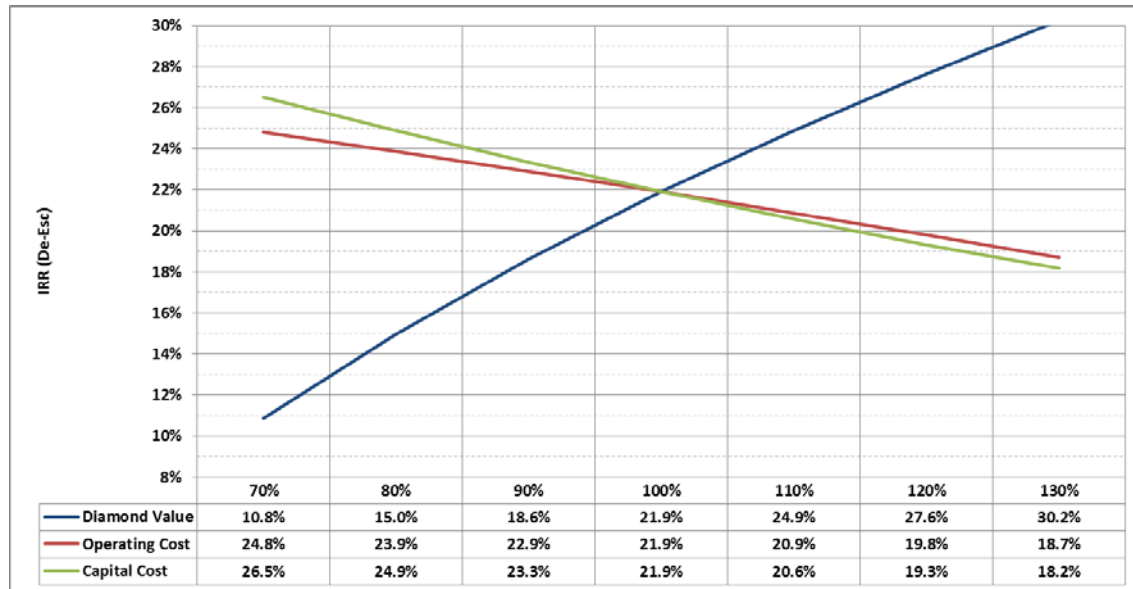
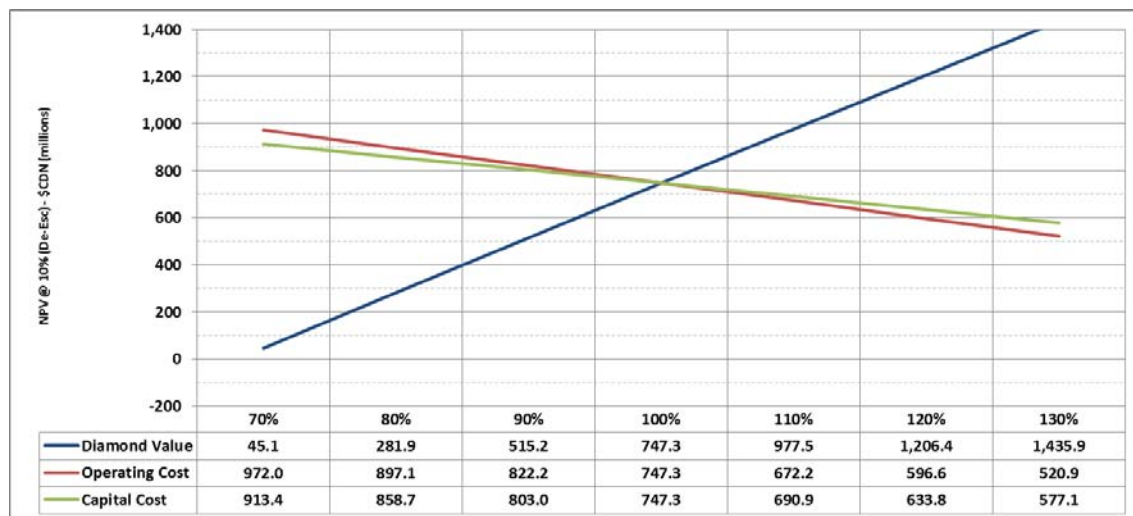

Figure 22-5: NPV Variation 3.0 Mt/a Case (sunk costs included)



The impact of the Canadian/US exchange rate on the %IRR is summarised in Table 22.11 below.

Table 22.11: Exchange Rate Impact on %IRR

Exchange Rate (CAD for US\$1.00)	1.034	1.059	1.084	1.109	1.134	1.159	1.184
BC – Excluding Sunk Costs	29.6%	30.6%	31.6%	32.6%	33.6%	34.5%	35.4%
BC – Including Sunk Costs	19.7%	20.5%	21.2%	21.9%	22.6%	23.3%	23.9%

Note – Exchange rate change is ± \$0.025 from base of \$1.109 CAD.

The sensitivity to diamond prices within the Minimum/High Model boundaries determined by WWW, are summarised in Table 22.12 for the Sunk Costs Excluded scenario.

Table 22.12: Diamond Price Sensitivity – WWW Estimated Range – Sunk Costs Excluded

Diamond Price Model Comparison	%IRR	NPV@10% (\$ M)
Minimum Model	27.3%	744.8
Model – Base Case	32.6%	1,004.8
High Model	44.9%	1,745.7

Note –Model reference terminology used by WWW and explained in Item 19

22.10 Scenario Performance

Project cash flows used in the evaluation are shown in Figure 22-6 through 22-9 for scenarios excluding and including sunk costs. Summary tables for the LOM annual production schedule and cash flows can be found in Tables 22.13 and Table 22.14 for the excluding sunk cost scenario.

The annual cash flow graph shows that the value of the project and benefiting from leveraging the tax pools to diminish taxes.

Anticipated costs and revenue streams in the transitions to the second and third pit can clearly be seen in both graphs.

Figure 22-6: Annual Cash Flow (C\$ M De-escalated) – Excluding Sunk

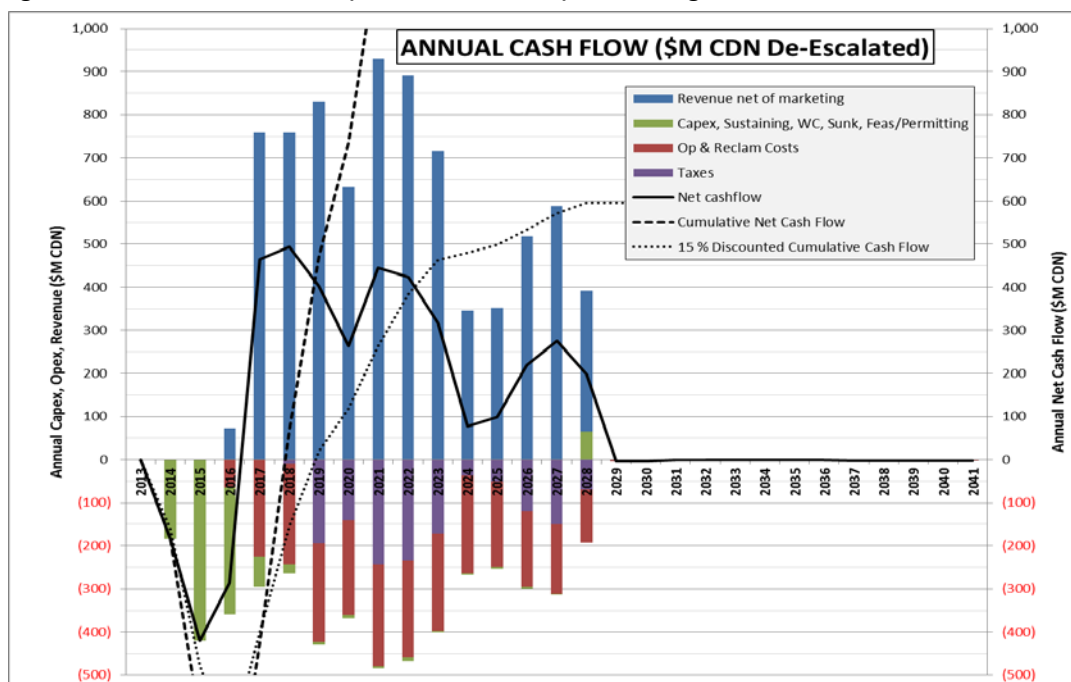

Figure 22-7: Cumulative Annual Cash Flow (C\$ M De-escalated) – Excluding Sunk

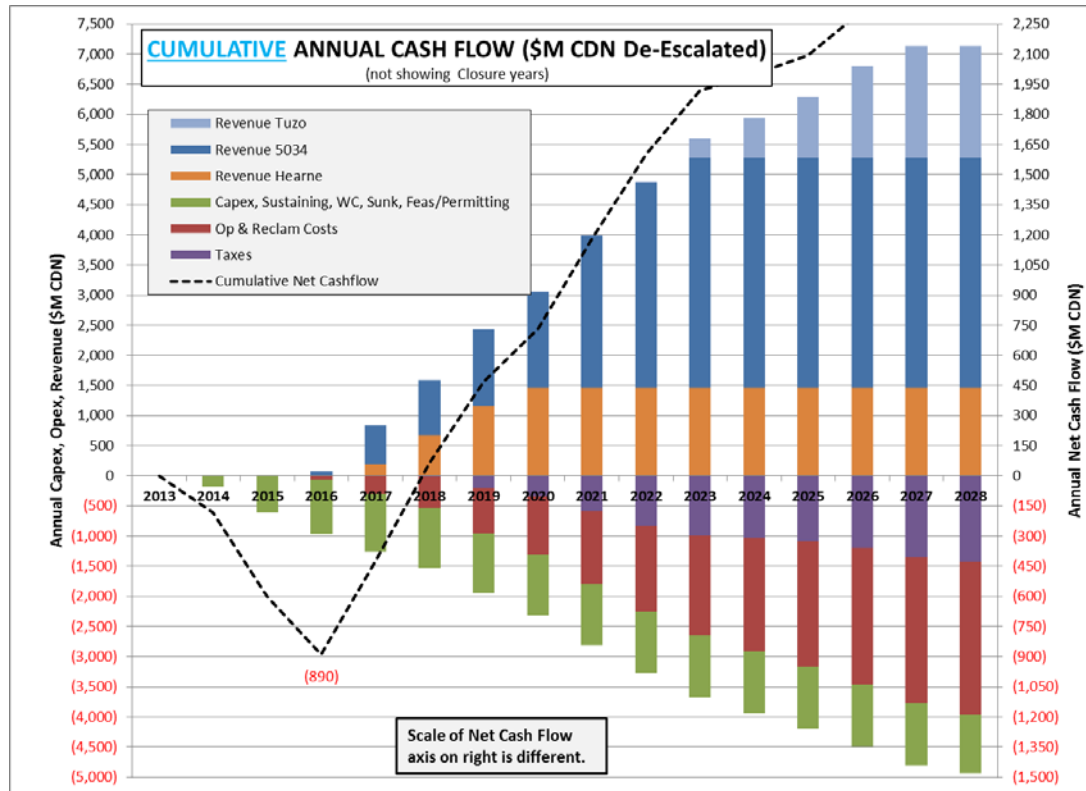

Figure 22-8: Annual Cash Flow (C\$ M De-escalated) – Including Sunk

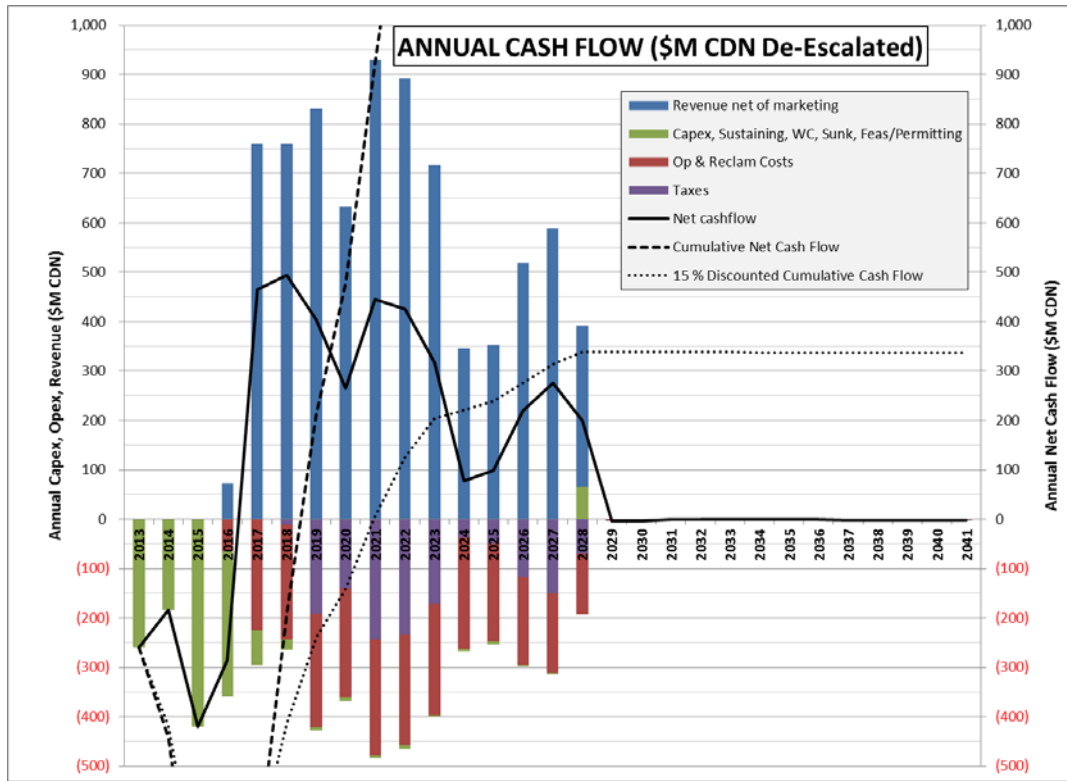

Figure 22-9: Cumulative Annual Cash Flow (C\$ M De-escalated) – Including Sunk

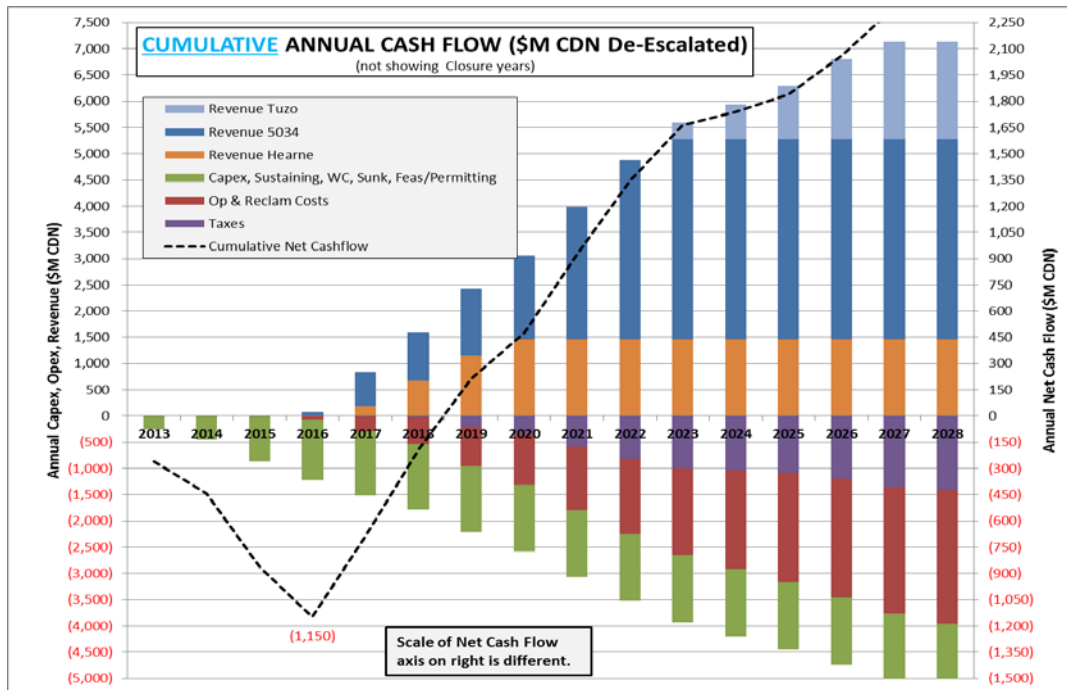

Table 22.12: LOM Annual Production Schedule and Costs (Excluding Sunk Costs)

PRODUCTION AND COSTS		Total	YearZero																
IRR	32.61%		2013	2014	2015	2016	2017	2018	2019	2020	2021	2022	2023	2024	2025	2026	2027	2028	
PRODUCTION						Plant Ramp-up													
	Waste (000's t)(O/B, Granite)	315,895	-	1,954	2,364	24,829	36,196	35,316	27,997	30,614	30,358	27,161	31,694	35,774	19,294	8,303	3,995	47	
	Plant Feed, begin (000's tonnes)	35,066	-	-	-	400	3,000	3,000	3,000	3,000	3,000	3,000	3,000	3,000	3,000	3,000	3,000	1,666	
	Plant Feed Tonnes per day milled		-	-	8,333	8,333	8,333	8,333	8,333	8,333	8,333	8,333	8,333	8,333	8,333	8,333	8,333	8,333	
	Days milled		-	-	-	48	360	360	360	360	360	360	360	360	360	360	360	200	
	Annual grade recovered (cpt)	1.52	-	-	#DIV/0!	1.19	1.75	1.88	1.99	1.46	1.85	1.73	1.59	0.90	0.90	1.31	1.47	1.44	
	Includes Diamond Price Esc Annual diamond value (US\$/ct)	149.66	-	-	-	143.96	138.97	131.12	138.11	144.99	171.37	178.13	158.38	137.06	141.31	145.69	150.20	154.86	
OPERATING COSTS		Total	2013	2014	2015	2016	2017	2018	2019	2020	2021	2022	2023	2024	2025	2026	2027	2028	
Operating costs per tonne (unesc)																			
	Mining	33.24	-	-	-	80.52	36.13	38.71	37.65	34.85	39.42	35.97	36.39	36.98	28.41	21.57	18.65	23.55	
	Processing	7.46	-	-	-	14.03	7.10	7.20	7.30	7.44	7.49	7.49	7.49	7.49	7.49	7.49	7.35	7.25	
	Freight	6.29	-	-	-	11.12	6.25	6.31	6.23	6.27	6.30	6.26	6.23	6.32	5.98	5.72	5.57	8.31	
	Power Plant	6.04	-	-	-	10.36	5.82	5.88	5.88	5.90	5.88	5.88	5.88	5.90	5.88	5.88	5.88	8.08	
	G&A	14.07	-	-	-	33.02	13.45	13.51	13.54	13.58	13.59	13.61	13.63	13.66	13.60	13.59	12.27	21.69	
	Sorting	0.83	-	-	-	0.65	0.95	1.03	1.08	0.80	1.01	0.95	0.87	0.49	0.49	0.72	0.80	0.79	
	Opex Contingency (Excl. Sorting) @ 3.62%	2.43	-	-	-	5.40	2.49	2.59	2.56	2.46	2.63	2.51	2.52	2.55	2.22	1.96	1.80	2.49	
	Management Fee (Excl. Sorting & Incl SIB)	2.15	-	-	-	4.63	2.29	2.38	2.25	2.18	2.31	2.23	2.19	2.22	1.95	1.72	1.56	2.18	
	Cost per tonne	72.51	-	-	-	159.74	74.47	77.61	76.49	73.48	78.64	74.90	75.21	75.61	66.04	58.66	53.89	74.34	
CLOSURE COSTS (Cdn\$ 000's)		Total	2013	2014	2015	2016	2017	2018	2019	2020	2021	2022	2023	2024	2025	2026	2027	2028	
	Closure expenditures	16,948	-	-	-	-	-	-	-	-	-	-	-	-	-	-	-	-	
CAPITAL COSTS (Cdn\$ 000's)		Total	2013	2014	2015	2016	2017	2018	2019	2020	2021	2022	2023	2024	2025	2026	2027	2028	
INITIAL CONSTRUCTION																			
Overall Project Summary (Excl. Sunk, Cont., & Freight)																			
	CDE Other	39,246	-	-	12,100	27,146	-	-	-	-	-	-	-	-	-	-	-	-	
	CL 41P Plant	67,891	-	8,511	44,102	15,278	-	-	-	-	-	-	-	-	-	-	-	-	
	CEE Other	140,909	-	51,789	48,401	40,719	-	-	-	-	-	-	-	-	-	-	-	-	
	CL 41 Infrastructure/Equipment	483,413	-	110,014	236,440	136,959	-	-	-	-	-	-	-	-	-	-	-	-	
	Freight	-	-	-	-	-	-	-	-	-	-	-	-	-	-	-	-	-	
	CDE Other	2,699	-	-	1,486	1,213	-	-	-	-	-	-	-	-	-	-	-	-	
	CL 41P Plant	5,160	-	975	2,972	1,213	-	-	-	-	-	-	-	-	-	-	-	-	
	CEE Other	10,201	-	2,437	5,945	1,819	-	-	-	-	-	-	-	-	-	-	-	-	
	CL 41 Infrastructure/Equipment	33,540	-	6,336	19,320	7,884	-	-	-	-	-	-	-	-	-	-	-	-	
	Capital Cost Contingency	-	-	-	-	-	-	-	-	-	-	-	-	-	-	-	-	-	
	CDE Other	4,996	-	-	2,130	2,866	-	-	-	-	-	-	-	-	-	-	-	-	
	CL 41P Plant	7,541	-	415	4,261	2,866	-	-	-	-	-	-	-	-	-	-	-	-	
	CEE Other	13,857	-	1,037	8,521	4,298	-	-	-	-	-	-	-	-	-	-	-	-	
	CL 41 Infrastructure/Equipment	49,017	-	2,696	27,695	18,627	-	-	-	-	-	-	-	-	-	-	-	-	
	Total construction capital	858,470	-	184,209	413,374	260,888	-	-	-	-	-	-	-	-	-	-	-	-	
	Escalation Profile	42,000	-	2,731	19,360	19,909													
OTHER CAPITAL COSTS																			
	Working Capital	-	-	-	-	25,709	54,427	-	-	-	-	-	-	-	-	-	-	(80,136)	
	CL 41 Tangible equipment	75,716	-	-	-	-	15,152	20,179	5,081	6,812	4,686	7,370	2,292	3,407	4,206	3,402	1,000	2,128	
	CDE Other than tangible equipment	-	-	-	-	-	-	-	-	-	-	-	-	-	-	-	-	-	
	Total other capital costs	75,716	-	-	-	25,709	69,580	20,179	5,081	6,812	4,686	7,370	2,292	3,407	4,206	3,402	1,000	(78,008)	

Not showing closure years (2029 – 2041), but reflected in economic model.

GAHCHO KUÉ PROJECT 2014 FEASIBILITY STUDY N.I. 43-101 TECHNICAL REPORT

Table 22.13: LOM Annual Cashflow (Excluding Sunk Costs)

MAIN			YearZero																
IRR	32.61%	Total	2013	2014	2015	2016	2017	2018	2019	2020	2021	2022	2023	2024	2025	2026	2027	2028	
CASHFLOW SUMMARY (Cdn\$ 000's)																			
Escalated																			
	Revenue net of marketing	8,780,297	--	--	--	76,125	805,901	816,463	907,071	700,743	1,045,273	1,017,272	829,716	406,145	419,858	626,610	722,886	406,235	
	Other royalty	--	--	--	--	--	--	--	--	--	--	--	--	--	--	--	--	--	
	Net revenue	8,780,297	--	--	--	76,125	805,901	816,463	907,071	700,743	1,045,273	1,017,272	829,716	406,145	419,858	626,610	722,886	406,235	
	Operating costs	(2,901,302)	--	--	--	(66,775)	(236,933)	(250,577)	(250,610)	(244,316)	(265,356)	(256,469)	(261,349)	(266,613)	(236,320)	(213,023)	(198,581)	(154,380)	
	Closure costs	(31,756)	--	--	--	--	--	--	--	--	--	--	--	--	--	--	--	--	
	Other	--	--	--	--	--	--	--	--	--	--	--	--	--	--	--	--	--	
	Cashflow from operations	5,847,239	--	--	--	9,351	568,968	565,886	656,460	456,427	779,917	760,803	568,367	139,531	183,538	413,587	524,305	251,855	
	Construction capital	(900,470)	--	(186,940)	(432,734)	(280,797)	--	--	--	--	--	--	--	--	--	--	--	--	
	Sunk costs: Studies & Exploration	--	--	--	--	--	--	--	--	--	--	--	--	--	--	--	--	--	
	Replacement/Sustaining & Working capital	(94,062)	--	--	--	(26,867)	(74,776)	(23,394)	(6,068)	(8,378)	(5,936)	(9,616)	(3,081)	(4,716)	(5,997)	(4,996)	(1,513)	81,273	
	Sunk: Feasibility studies & permitting	--	--	--	--	--	--	--	--	--	--	--	--	--	--	--	--	--	
	Taxes	(1,637,897)	--	--	--	(229)	(1,198)	(11,280)	(211,579)	(155,466)	(273,497)	(267,006)	(198,882)	(43,850)	(60,230)	(144,033)	(184,596)	(86,051)	
	Other	--	--	--	--	--	--	--	--	--	--	--	--	--	--	--	--	--	
	Net cashflow	3,214,809	--	(186,940)	(432,734)	(298,542)	492,994	531,213	438,814	292,583	500,484	484,181	366,405	90,965	117,311	264,558	338,196	247,077	
	Cumulative cashflow		--	(186,940)	(619,674)	(918,216)	(425,222)	105,992	544,805	837,388	1,337,873	1,822,053	2,188,458	2,279,423	2,396,734	2,661,292	2,999,488	3,246,565	
IRR		34.57%																	
NPV@	10%	1,182,288																	
NPV ESTIMATE (Cdn\$ 000's)																			
De-escalated																			
	Inflation for de-escalation		1.000	1.015	1.030	1.045	1.061	1.076	1.092	1.108	1.125	1.141	1.158	1.175	1.193	1.210	1.228	1.247	
NPV																			
3,542,001	Revenue net of marketing	7,720,760	--	--	--	72,843	759,906	758,637	830,536	632,260	929,364	891,278	716,349	345,538	351,995	517,668	588,496	325,889	
--	GOR royalty	--	--	--	--	--	--	--	--	--	--	--	--	--	--	--	--	--	
--	Other royalty	--	--	--	--	--	--	--	--	--	--	--	--	--	--	--	--	--	
3,542,001	Net revenue	7,720,760	--	--	--	72,843	759,906	758,637	830,536	632,260	929,364	891,278	716,349	345,538	351,995	517,668	588,496	325,889	
(1,145,994)	Operating costs	(2,542,763)	--	--	--	(63,895)	(223,410)	(232,830)	(229,465)	(220,439)	(235,931)	(224,704)	(225,640)	(226,828)	(198,123)	(175,987)	(161,663)	(123,846)	
(3,309)	Closure costs	(23,198)	--	--	--	--	--	--	--	--	--	--	--	--	--	--	--	--	
--	Other	--	--	--	--	--	--	--	--	--	--	--	--	--	--	--	--	--	
2,392,698	Cashflow from operations	5,154,799	--	--	--	8,948	536,495	525,808	601,071	411,821	693,433	666,574	490,709	118,710	153,872	341,681	426,832	202,043	
(716,613)	Construction capital	(873,107)	--	(184,213)	(420,204)	(268,689)	--	--	--	--	--	--	--	--	--	--	--	--	
--	Sunk costs: Studies & Exploration	--	--	--	--	--	--	--	--	--	--	--	--	--	--	--	--	--	
(83,966)	Replacement/Sustaining & Working capital	(96,630)	--	--	--	(25,709)	(70,508)	(21,737)	(5,556)	(7,559)	(5,278)	(8,425)	(2,660)	(4,012)	(5,027)	(4,127)	(1,231)	65,199	
--	Sunk: Feasibility studies & permitting	--	--	--	--	--	--	--	--	--	--	--	--	--	--	--	--	--	
(587,364)	Taxes	(1,420,746)	--	--	--	(219)	(1,130)	(10,481)	(193,727)	(140,273)	(243,169)	(233,936)	(171,708)	(37,307)	(50,495)	(118,992)	(150,278)	(69,032)	
--	Other	--	--	--	--	--	--	--	--	--	--	--	--	--	--	--	--	--	
1,004,756	Net cashflow	2,764,317	--	(184,213)	(420,204)	(285,670)	464,858	493,590	401,788	263,989	444,986	424,212	316,342	77,391	98,350	218,562	275,323	198,210	
	Cumulative cashflow		--	(184,213)	(604,417)	(890,087)	(425,229)	68,361	470,149	734,139	1,179,125	1,603,337	1,919,679	1,997,070	2,095,419	2,313,982	2,589,305	2,787,514	
IRR		32.61%																	
NPV@	10%	1,004,756																	

Not showing closure years (2029 – 2041), but reflected in cumulative cashflow.

22.11 Payback

The Payback period following completion of permitting/construction and the ramp-up (5 months) to commercial production (defined as 100% of nameplate, sustained for 3 days by end of January 2017) and excluding interest payments is 1.8 years excluding sunk costs.

22.12 Mine Life

The operating mine life of the Gahcho Kué project, based on the assumptions in the Gahcho Kué 2014 Feasibility Study Report, is 12 years. This includes the processing plant ramp up during the initial operating period, but excludes the initial site construction, mine pre-production, and site closure activities once the processing plant has ceased to operate.

Extending the life of the mine would rely on potential conversion of existing inferred resources to reserves and/or discovery of additional resources/reserves within current and ongoing exploration activities.

SECTION 23 ADJACENT PROPERTIES

There are three producing diamonds mines of similar size operating in the NWT:

- Ekati Diamond Mine (Dominion Diamonds)
- Diavik Diamond Mine (Rio Tinto)
- Snap LakeDiamond Mine (De Beers).

Mineral rights in the area surrounding the GKJV mineral claims are held by other mining companies, either through leases or mineral claims. The surrounding lease/claims are held by:

- Kennady Diamonds
- Margaret Lake Diamonds
- De Beers-Gerle Gold JV.

Kennady Lake North (Kennady Diamonds) is the only active diamond exploration project in the direct vicinity of the Gahcho Kué project. The project has conducted drilling activities on several diamond bearing kimberlite bodies immediately to the Northeast of the GKJV leases. Exploration drilling activities are currently active.

The following excerpt is taken from a March 17, 2014 press release from Kennady Diamonds:

An 8,500 metre drill program conducted in 2013 returned exceptional sample grades. A 4.3 tonne sample from the Kelvin kimberlite returned a grade of 5.38 carats per tonne. A smaller 116 kg sample from the Faraday kimberlite returned a sample grade of 11.23 carats per tonne. The three largest diamonds recovered from the Kelvin kimberlite were a 2.48 carat off-white transparent octahedral, 1.06 carat off-white broken aggregate and a 0.90 carat off-white transparent irregular. The recovery of diamonds of this size and quality from a 4.3 tonne sample is very encouraging.

The Authors cannot verify or disclaim information regarding this property.

SECTION 24 OTHER RELEVANT DATA & INFORMATION

24.1 Project Execution

24.1.1 OVERVIEW

The key objectives of the project during design, procurement, construction and operation are to:

- Prevent harm to people, the environment and assets.
- Complete the project within the established economic parameters (capital and operating budgets).
- Complete the project within the planned development timeline (on schedule).
- Use proven operating practices and experience from other diamond mines in arctic environments.

Project execution for the Gahcho Kué Project is based on tested and proven principles utilised in the development of diamond mines in the Canadian Arctic. These principles include:

- Plan around winter ice roads.
- Contract with suppliers, contractors, and engineers that have proven track records in Canadian Arctic diamond mine developments.
- Purchase mine equipment fleet at project onset (by Owner) and use for all bulk earthworks.
- Develop one camp with the same living status applied to all site personnel.
- Standardize equipment where practical and use De Beers preferred suppliers.

The only road access to site will be an ice road that will be used to transport all heavy and bulky material. The ice road is open for two months every year, generally in February and March. The execution strategy has been developed around this constraint. People and goods for the camp will be flown into the site area along with smaller and lighter equipment and material required for the construction work that can be mobilised by air. Until the airstrip is operational, personnel will be flown in via small aircraft during the summer and large fixed-wing aircraft landing on an ice airstrip during winter

The project will be executed in steps as equipment and material are shipped on the ice road.

The first part of execution is the pioneer work required to establish the basic elements that must be in place for people and goods to be brought into the area:

- site setup
- camp development, including potable water treatment and sewage treatment (with incinerator)
- air strip construction
- construction of part of the fuel farm.

The second year of the ice road will be used to mobilize materials for the remainder of the plant. Pre-fabrication of modules will be considered within the constraints of the ice road capacity and sufficient advancement of the design in time to facilitate prefabrication. Specifications for all possible pre-assemblies will be developed in the early stages of the detailed design work.

There are two distinct packages of work to be delivered during site construction:

- **Bulk Earthworks:** All required earthworks leading up to the process plant start-up will be completed using Owner supplied and maintained mobile equipment operated by contracted labour operators and supervision.
- **Facilities Erection:** The EPCM team will manage and administer erection of facilities through a site-wide General Contractor (GC), the selection of which will be based upon validated NWT experience and competitive labour rates. The scope of services provided by the GC includes procurement of construction materials, provision of construction labour, and execution of all work defined in the provided scope of work document.

Procurement activities started in the fall of 2013 for packages critical to the 2014 winter road. All future activities has taken into consideration expected lead time for equipment, bulks and fabrication as well as quality inspection requirements and the need for on-site expediting. Lead times were established through contact with potential bidders during the fall of 2013.

Engineering activities have been well advanced in the feasibility study phase. All long lead equipment has been purchased and the early works packages to be constructed in 2014 have been developed so that construction can be well planned and executed in a safe manner. Engineering has been sequenced from construction and procurement activities so that equipment and facilities are designed in time to order and deliver components and materials to site as scheduled.

Table 24.1 highlights the key project milestones of the project.

Table 24.1: Key Period Milestones

Milestone	Targeted Start	Targeted Finish
Pioneer Works Permit Issued / Start work	Dec. 2013	
2014 Ice Road	Feb. 2014	March 2014
Air Strip Operational		May 2014
Permanent Camp Installation	June 2014	Sep. 2014
Land Use Permit/Water Licence Issued	Oct. 2014	
2015 Ice Road	Feb. 2015	March 2015
Concrete Works	April 2015	
Mechanical Works	May 2015	May 2016
Emulsion Plant Completed		Dec. 2015
Truck Shop Completed		Dec. 2015
2016 Ice Road	Feb. 2016	March 2016
Process Plant Mechanical Completion		May 2016
Commissioning Commence	May 2016	
First Kimberlite in Plant	Sept. 2016	
Ramp Up To Full Production	Sept. 2016	Jan. 2017

Hatch shall manage the project on behalf of the DBCI. This will include all EPCM services. Hatch is responsible for the overall performance of the EPCM work, including the work performed by EBA and JDS. Hatch will lead the design of the process plant, camp, auxiliary buildings, utilities and provide the overall site manager, as well as procurement, engineering and overall project management.

JDS Energy & Mining Inc. (JDS) and EBA Engineering, Inc. (EBA), shall work as subcontractors to the Hatch team and execute specific elements of EPCM as per the approved staffing plan defined between these parties. JDS is responsible for the mine design. JDS also has significant experience constructing diamond mines in the region and will provide the site construction management and logistics services to the project. EBA will continue its mandate to provide geotechnical services, as well as dewatering, dyke, and civil design for the fuel farm and roads.

Safety is an important element of the site work. A Safety, Health and Environment Plan has been developed in detail using the best practices from all involved parties to ensure the safest execution possible.

24.1.2 PROJECT EXECUTION PLAN (PEP)

A Project Execution Plan (PEP) has been developed for the project. The PEP is a standalone set of documents that collectively define the entire method of project execution.

The PEP, through a planning process, outlines the following concepts and details:

- The strategy associated with how the project will be delivered.
- How the project will be organised; project team roles and responsibilities delegations of authority, authority levels, etc.
- Project baselines, budgets, schedules, constraints, and risks.

The Project Execution Plan (PEP) consists of three related components:

- Part A – Project Definition and Execution Strategy
- Part B – Functional Execution Plans
- Part C – Procedures Manual Register.

Part A of the PEP provides the project context and the overall project delivery approach, as well as information required for the management team to become aligned and drive project performance.

Part A of the PEP includes:

- Project definition
- Project level responsibilities and authorities agreed upon with the Client
- Project objectives and delivery strategies
- Critical contractual terms.

Part B of the PEP provides Functional Execution Plans (FEP) that describe specific work plans by each project function. Each work plan should enable the team and any third party to clearly understand:

- What is to be done
- Why it is to be done
- How it is to be done
- Where is the work to be completed
- When the work is to be done
- How the work is to be monitored to ensure that the team can monitor and measure progress towards the delivery of the project objectives
- Who is responsible for completing the work.

For the Gahcho Kué project, the Functional Execution Plans include:

- Engineering Execution Plan
- Procurement Execution Plan

- Construction Execution Plan
- Quality Management Plan
- Value Improvement Practices
- Security Management Plan
- Risk Management Plan
- Safety, Health & Environment (SHE) Execution Plan
- Project Controls Execution Plan
- Change Management Execution Plan
- Commissioning Plan.

Each of these plans come complete with the appropriate appendixes to properly describe the roll out of the project.

24.2 Water Management & Hydrology

The key water related activities for the mine will be the dewatering of Areas 2 to 7 of Kennady Lake before operation, managing water in the Water Management Pond (“WMP”) during operation, and the subsequent refilling of Kennady Lake during mine closure. A key feature of the Plan is to use the headwater location and natural topography of the Kennady Lake watershed to isolate water that may be exposed to the disturbed area of the mine site (forming the controlled area). This is achieved by diverting inflows from the upper watersheds during construction, operations, and closure phases of the mine to lakes in the adjacent N watershed and dyking outflows from Kennady Lake. In this way, all of the water generated within the mine area can be managed through a passive approach within the controlled area, with licensed discharges being the only water transferred (pumped) out of the controlled area. The following section provides a summary of the Plan that has been developed for the mine.

Eight sub-watershed areas (Areas 1 to 8) (Figure 24-1) have been designated in the mine area. Area 1 is located northeast of Kennady Lake and includes Lakes A1, A2, A3, and A9, while Areas 2 to 8 are within Kennady Lake. Areas 1 to 7 will form the controlled area for water management purposes. Area 8 is a sub-watershed of Kennady Lake, but it is outside the controlled area boundary. Construction of perimeter and internal water retention dykes is expected to begin during the construction phase and continue through the operations phase, as required.

Figure 24-1: Pre-disturbance Site Plan

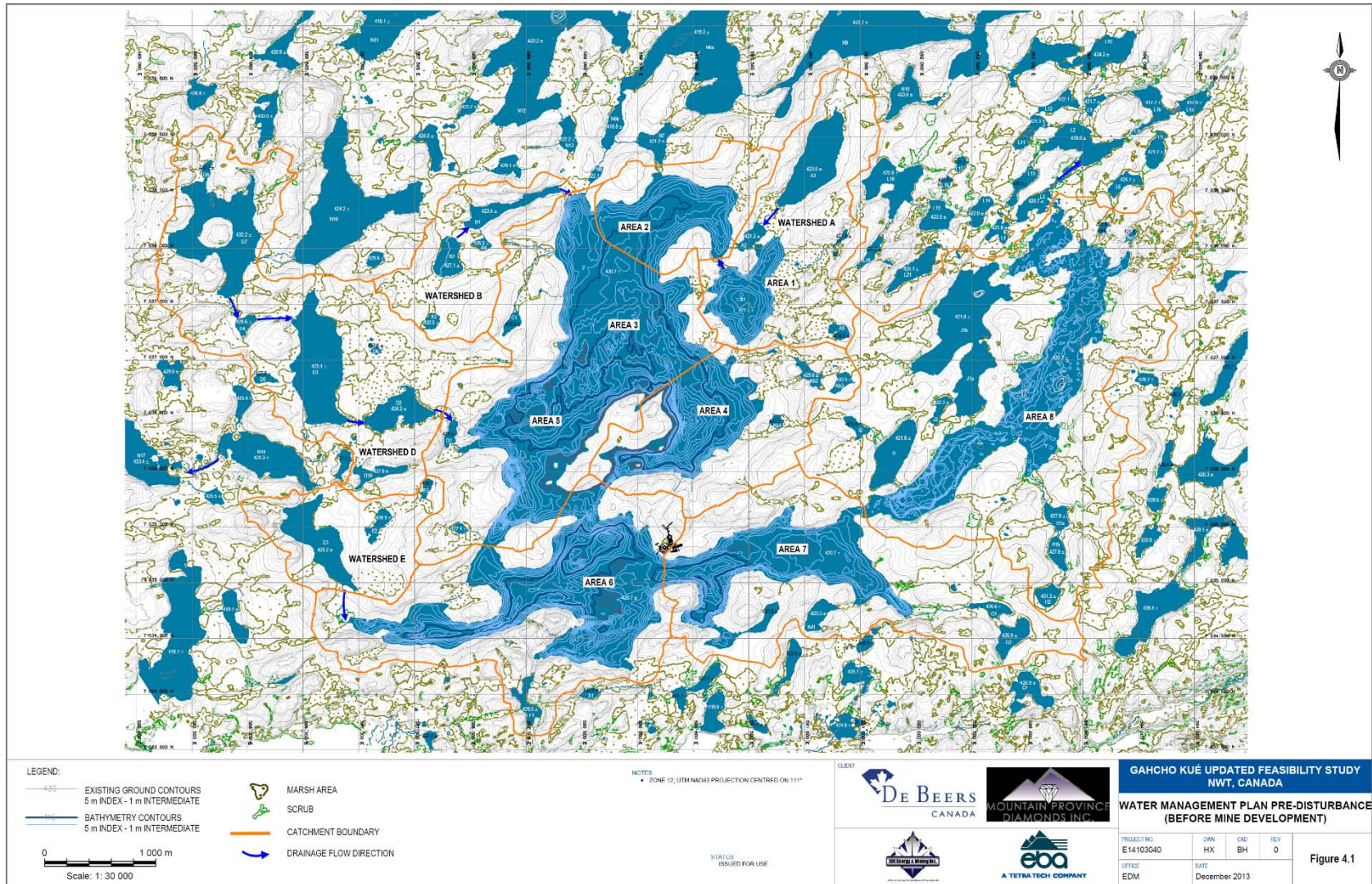

The Mine Water Management Plan (“MWMP”) is discussed in terms of the following periods:

- Construction phase – Areas 2 to 7 of Kennady Lake are drawn down to provide safe access to kimberlite bodies for open pit operation, to increase available basin capacity, and to facilitate dyke construction; clean water is discharged to Lake N11 and Area 8.
- Operational phase – Water is managed within the WMP (Areas 3 and 5) and the mined-out pits; water that meets discharge requirements will be discharged from the WMP to Lake N11 or to Area 8 as downstream flow mitigation. Excess catchment water from Watershed A (Lake A1) will be discharged to Area 8 via Lake J1b.
- Closure phase – The drained Kennady Lake basin including the mined-out Tuzo pit will be refilled with natural drainage and supplemented with water pumped from Lake N11 to expedite the lake recovery. Downstream flow mitigation to Area 8 will continue through closure.
- Post-closure – Kennady Lake is reconnected to Area 8 when water quality meets discharge requirements.

More than half the footprint of the 5034 pit that will be mined is covered by the water. Therefore, dewatering of Kennady Lake is required for safe access and the mining of this pit. The objective of the dewatering program will be to drain Areas 2 to 7 of Kennady Lake to the maximum extent possible. After this initial dewatering, Areas 6 and 7 will be isolated and drained completely into Area 5. Fish-out activities will be conducted to remove fish from Areas 2 to 7 before and during dewatering.

During operations, water management will involve a variety of tasks including:

- further dyke construction for water management
- managing a water management pond for water storage and a source of recycled water to the processing plant as make-up water, and discharging water that meets discharge requirements
- managing groundwater from the open pits
- dewatering Area 4 to safely access the Tuzo kimberlite body for mining
- containing and managing site runoff and dyke seepage
- recycling water to the processing plant as make-up water
- pumping water from WMP or Lake N11 to the Area 8 watershed for downstream flow mitigation.

Once operations have ceased the focus of the water management will shift to restore the natural flow regime and pre-disturbance conditions of Kennady Lake to the extent practical and allow the restored Kennady Lake to return to productive fish habitat as quickly as possible. Activities implemented to ensure this are summarised below:

- restoration of Kennady Lake
- maintaining downstream flow mitigation during the refilling of Kennady Lake

- reconnection of site-wide drainage patterns through dyke dismantling
- reconnection to downstream watersheds.

24.3 Mineral Waste Management

Two areas, one on the southeast of Area 6 and another on the south of Area 5, were identified as feasible locations for mine rock storage after assessment of other potential options. The major advantages of the locations include short haul distances from 5034 and Hearne pits, minimize the overall site footprint disturbance, the confined footprint within the natural catchment area of the original Kennady Lake, and passive water management as contact water naturally flowing into the internal and controlled water storage basins.

Most of the mine rock produced during Tuzo pit development will be placed in the mined-out 5034 pit when it becomes available after 2022.

Table 24.2 summarizes the adopted mine rock disposal locations and the projected yearly quantities of mine rock to be placed in each of the four locations and includes the mine rock to be used for site construction. These quantities are inclusive of overburden during periods when overburden is mined.

Table 24.2: Mine Rock Disposal Locations & Yearly Quantities Placed

Year	5034 Mine Rock					Hearne Mine Rock				Tuzo Mine Rock				
	[million t]					[million t]				[million t]				
	Total Mined	To Roads & Dykes	To South Mine Rock Pile	To West Mine Rock Pile	To Hearne Pit	Total Mined	To Roads & Dykes	To South Mine Rock Pile	To West Mine Rock Pile	Total Mined	To Roads & Dykes	To 5034 Pit	To Hearne Pit	To West Mine Rock Pile
2014	2.0	1.9	0.0	-	-	-	-	-	-	-	-	-	-	-
2015	2.4	2.4	0.0	-	-	-	-	-	-	-	-	-	-	-
2016	24.8	3.3	21.5	-	-	-	-	-	-	-	-	-	-	-
2017	18.4	0.3	18.0	-	-	17.8	-	17.8	-	-	-	-	-	-
2018	19.1	-	19.1	-	-	16.2	-	12.2	4.0	-	-	-	-	-
2019	13.7	0.3	13.3	-	-	14.3	-	-	14.3	-	-	-	-	-
2020	9.2	1.7	-	7.4	-	5.3	-	-	5.3	16.2	0.3	-	-	15.9
2021	16.0	-	-	16.0	-	-	-	-	-	14.4	0.0	-	-	14.3
2022	9.5	-	-	9.5	-	-	-	-	-	17.6	0.0	-	8.6	9.0
2023	1.8	-	-	1.4	0.4	-	-	-	-	29.9	0.0	26.0	-	3.9
2024	-	-	-	-	-	-	-	-	-	35.8	0.0	35.8	-	-
2025	-	-	-	-	-	-	-	-	-	19.3	0.2	19.1	-	-
2026	-	-	-	-	-	-	-	-	-	8.3	0.0	8.3	-	-
2027	-	-	-	-	-	-	-	-	-	4.0	0.0	4.0	-	-
2028	-	-	-	-	-	-	-	-	-	0.0	0.0	0.0	-	-
Total	116.8	10.0	72.0	34.3	0.4	53.7	-	30.1	23.6	145.5	0.6	93.1	8.6	43.1

Area 2 has been identified as the most feasible location for fine processed kimberlite (PK) deposition during initial years after an assessment of other potential options. The major advantages of this location is the confined footprint within the natural catchment area of the original Kennady Lake, water naturally flowing into the water storage pond in Area 3, relatively close to the process plant, and easy reclamation for closure.

The fine PK slurry will be discharged into the mined-out Hearne pit after 2020. Table 24.3 summarizes the overall fine PK management plan.

Table 24.3: Fine PK Management Plan

Planned Fine PK Deposition Location	Area 2 Fine PK Facility	Mined-out Hearne Pit
Mine Production Period	Year 1 to 4	Year 5 to E.O.M
Total Dry Fine PK Placed (Mt)	3.7	6.8
Fine PK Slurry Deposition Method	Discharge at spigot locations above water elevations	Underwater discharge
Maximum Elevation of Settled Fine PK (masl)	431	371

The deposition plan of the processed kimberlite (“PK”) is summarised as follows:

- During the first four years of operations, fine PK will be stored in the fine PKC facility.
- From Year 5 to end of life of mine, fine PK will be deposited into the mined-out Hearne pit.
- Coarse PK will be placed in the on-land coarse PK pile and placed with mine rock. There is flexibility in the sequence of placing the coarse PK. Currently, it is planned that coarse PK will be placed in the on-land coarse PK Pile during the first five years of mining operations and placed with mine rock in the west mine rock pile thereafter. Coarse PK may also be used for reclamation of the fine PKC facility. Alternatively, the coarse PK can be placed with mine rock in either one of the mine rock piles or the mined-out pits before or after the on-land coarse PK pile reaches its full capacity.
- All PK material will be contained within the controlled area of Kennady Lake.
- Fine PK is expected to comprise only 30% by weight of the PK waste streams. PK grits will be dewatered and combined with the coarse PK for a combined weight fraction of 70%. The actual split at any given time will vary due to the variability in the plant feed, thus the designed flexibility of the disposal plan.

Pumping of fine PK in thickened slurry form, and dewatering and trucking of the coarse and grits PK fractions are the planned means of PK transport for the mine. Coarse and grits PK can be readily dewatered and trucked. However, the fine PK for the mine cannot be effectively dewatered to the extent required to make truck transport and dry stacking of the material feasible. Fine PK must therefore be transported by pipeline to the fine PKC facility, and later to the mined-out Hearne pit as thickened slurry.

Coarse PK can be co-disposed with mine rock, or placed in the mined-out pits. Table 24.4 summarizes the overall coarse PK management plan.

Table 24.4: Coarse PK Management Plan

Planned Coarse PK Deposition Location	On-land Coarse PK Pile in Area 4	Cover over Final Fine PK Surface in Area 2	Mine Rock Piles Or Hearne Pit
Approximate Time Period during Mine Production	2016 to 2022	2022 to 2024	2024 to end of mine production
Estimated Total Volume of In-place Coarse PK (Mm ³)	6.1	1.6	3.9

Beginning by Year 5, all fine PK discharge will be directed to the mined-out Hearne pit. Room in the 5034 pit is reserved for pre-stripping of Tuzo pit, which begins in Year 2022.

The Tuzo pit, being the last to be mined, will not be backfilled with mine rock or processed PK.

24.4 Mine Closure

Post-mining activities centre on providing support for the reclamation effort. While most landforms such as the waster rock piles, coarse PK pile and the fine PKC facility will have been reclaimed progressively throughout the mine operations phase, it will take time after closure to refill Kennady Lake and stabilize natural water flows.

The final year of production will include the start of decommissioning, demolition and re-grading of all buildings and facilities that are not required for the post-closure and monitoring periods. All remaining site mobile equipment will be available for this task when mining is complete. A small maintenance and closure support fleet will be left on site to support the closure and monitoring phase of the project. Two (2) winter roads for demobilization will be required following the end of operations and the final ultimate demobilization after lake refilling will be done via air.

Monitoring of water quality and annual pumping to augment the filling of Kennady Lake will be carried out during this post-closure phase with a final cleanup planned when the reclamation of the site is finally deemed complete. Thus, access via air to site during summer and required services to support the post-closure activities will be maintained.

Over the mine life, the project will have produced the following mine wastes:

- mine rock: projected total of 306.5 Mt
- waste overburden: till and lake bottom sediments, projected total of 9.4 Mt
- mill feed: projected 35.1 Mt, of which 30% on average will be fine PK and 70% coarse PK.

The objective of the reclamation plan for the mine is to minimize the lasting environmental impacts of operations to the extent practical and to allow disturbed areas to return to productive fish and wildlife habitat as quickly as possible.

Short-term reclamation objectives are to:

- progressively reclaim disturbed areas as soon as they are no longer active
- minimize the risk and impact of water erosion and sediment transportation
- stabilize slopes
- prevent soil drifting/dust.

Long-term objectives are to:

- restore productive fish habitat
- maintain the level of wildlife habitat.

De Beers has made the following specific commitments with respect to achieving these objectives for the Gahcho Kué project:

- through efficient design, minimize the total project footprint
- to the extent practical, minimize disturbed areas at any one time through progressive reclamation
- assess reclamation alternatives through the mine life to determine what prescriptions work most effectively at Gahcho Kué
- liaise with other mines in the Canadian Arctic regarding reclamation initiatives at their mine sites.

This abandonment and restoration plan is consistent with the objectives of the *Mine Site Reclamation Policy for Northwest Territories* (INAC, 2002) and the associated reclamation guidelines (INAC, 2004).

The general components of the reclamation program are summarised as follows:

- progressively backfill Hearne and 5034 pits with fine PK and mine rock and PK as each pit becomes available
- progressively reclaim the fine PKC facility during the mine life:
 - As stability of the deposited fine PK allows, a layer of coarse PK will be spread progressively from the edges of the facility towards the centre to control dust and provide a platform for the final surface.
 - The final reclamation surface will consist of a thick layer of non-reactive mine rock to encapsulate the underlying PK and encourage establishment of permafrost.
- progressively reclaim the coarse PK pile by covering it with a layer of non-reactive mine rock
- re-slope rock dumps to a stable maximum overall 2.5:1 overall slope angle (22°) progressively during mining operations
- dismantle and demolish all buildings and structures and remove all above-grade concrete footings and foundations

- remove all potentially hazardous materials from site
- establish and maintain fish habitat structures as per the final DFO fish habitat compensation program
- supplement the refilling of Kennady Lake by pumping to shorten the time required to re-establish pre-disturbance flows in the watershed.

24.5 Operational Readiness

An Operational Readiness Implementation (ORI) Study has been performed by DBCI for the Gahcho Kué project. The ORI Study establishes plans to ensure that the mine is effectively staffed for commissioning, ramp-up and operation. Hatch has reviewed the ORI plans and is of the opinion that they are adequate for use in the Report.

The ORI Study included input from assigned DBCI corporate and operations people in defining the organizational structures, operations labour requirements for the future mine, and in developing the schedule of activities the future operations team will need to carry out.

Relevant corporate guidelines have been consulted and implemented.

The main deliverables of the ORI Study include:

- Development of operational readiness considerations and integrating these into strategies and planning requirements.
- Operational readiness preliminary implementation strategies for the overall mine and for human resources, engineering maintenance and SHE in detail.
- A Level 3 OR implementation schedule of activities with input from operations personnel for each work-stream (discipline or department) required for an operation.
- A preliminary Operational Readiness Implementation Start-up Plan that lists all the early activities of Operational Readiness Implementation (ORI). It serves to support the need for this work and the timing of the hiring of Operations personnel.
- A Preliminary OR Risk Management Review.
- An Operational Readiness Project Execution Plan (PEP). This also sets out how the OR Implementation will be managed.

The Gahcho Kué project is a joint venture of De Beers Canada Inc. (DBCI) and Mountain Province Diamonds Inc. (MPV). De Beers Canada, the project operator, currently operates two mines in Canada including the Snap Lake Mine in the NWT. Through the Snap Lake mine operation and the regional office in Yellowknife, De Beers is intimately familiar with local contractors and suppliers, aboriginal groups, permitting procedures and regulatory authorities, government diamond valuation procedures, and experience with the local workforce. The existing administrative and managerial capacity provides a ready-made operational capability in these areas.

A detailed operating capability plan and schedule will be compiled during the permitting phase of the project (i.e., 2014) based on the strategies and sequencing contained in this report. Management and personnel sourcing plans, detailed scopes for operations contracts, business and safety procedures, and other operating capability needs will be compiled and updated during this time.

The Gahcho Kué project operational readiness plan includes the establishment of the following departments to be in place at the commencement of operations:

- finance
- supply chain
- human resources (leadership, people and organization)
- technical services (including mineral resource management)
- information technology and communications
- safety, health and environment (including risk management/safety and sustainable development)
- mining
- processing
- maintenance
- protective services.

These departments' processes, practices and recruitment requirements will be undertaken as each department head is recruited. It will be the responsibility of the mine General Manager to ensure that plans are developed, implemented, reviewed and approved.

24.6 Risk Management

Hatch has compiled the risk management assessment and is of the opinion that the major foreseeable risks are identified and appropriate mitigation actions have been planned.

The remoteness of the Gahcho Kué mine and process plant, located in the District of Mackenzie, 300 km east-northeast of Yellowknife and 80 km east-southeast of the existing Snap Lake Mine (operated by DBCI), leads to significant risks to the project cost and schedule.

In order to increase the likelihood that the project reaches its objectives, project risk and technical risk workshops were held. Risk assessment was performed by combining the threats identified through project risk reviews, safety, health and environment (SHE) reviews and hazard & operability (HAZOP) reviews.

As per De Beers Canada / Anglo American Risk Management Plan, the most significant risks (threats) to the project objectives are reported using CURA – Top 20 Risk Dashboard (see Figure 24-2).

Figure 24-2: Top 20 Risk Dashboard

Risk Name	Domain Name	Control Effectiveness	Residual Risk	Remaining Risk
1. Significant Project delay due to key permits being delayed (1)	Gahcho Kue		23	21
2. Primary crusher -poor performance (243)	Gahcho Kue		23	14
3. WL & LUP application triggers project delay. (286)	Gahcho Kue		22	22
4. MVLWB impose WL & LUP conditions that require update to engineering or mine plan (287)	Gahcho Kue		22	22
5. Resource Estimate - High variance on grade and/or diamond value estimates(289)	Gahcho Kue		22	22
6. Diamond Prices Volatility. Change more than 10% (44)	Gahcho Kue		22	22
7. Delivery load weight limited by Ice road (233)	Gahcho Kue		22	19
8. Water Utilisation (108)	Gahcho Kue		22	19
9. Inadequate spur road - Capacity limit (234)	Gahcho Kue		22	13
10. Delays in Approving Capital Approval Requests (282)	Gahcho Kue		21	18
11. Inadequate mobile equipment maintenance(283)	Gahcho Kue		21	15
12. Winter Road - Operation - Interruption Due to Weather (92)	Gahcho Kue		20	16
13. Lack of accommodation on mine (273)	Gahcho Kue		20	13
14. Drilling - Mechanical Failure (215)	Gahcho Kue		18	18
15. Acquiring and Retaining Qualified People (167)	Gahcho Kue		18	18
16. Rapid Ramp-up of Personnel on Site (165)	Gahcho Kue		18	18
17. Fisheries Authorizations- Permtting HADD & fish compensation plans (11)	Gahcho Kue		18	18
18. Winter Road - Construction / Upgrade (87)	Gahcho Kue		18	18
19. Impact of the loss prevention appraisal by GRC (AAplc insurance consultant)(12)	Gahcho Kue		18	18
20. Community and local government conflict that derails GKP progress (269)	Gahcho Kue		18	17

Note: Numbers in blue refer to the placement of the identified risk within De Beers risk register.

Mitigation measures (preventive in many of the Top 20 cases) have been identified to address threats that allowed reducing their Remaining Risk rating. For some threats, the cost estimate has been revised or the scheduled has been adjusted to minimize the likelihood of unwanted events or to reduce their impact.

During the next phase, the proposed mitigations measures will be evaluated, reviewed and implemented to reduce the Remaining Risk rating of threats, which are in some cases detrimental to the project objectives.

The remoteness of the mine and processing plant as well as the limited accessibility of the site (e.g., ice road available 2 months per year) involved inherent risks (threats) to the project objectives.

As mitigation measures are implemented, the remaining risk level is being updated to reflect the latest information.

SECTION 25 INTERPRETATION & CONCLUSIONS

25.1 Interpretation

The Qualified Persons, as Authors of their corresponding Sections of this Report, have reviewed that data for the Project and are of the opinion that:

- Mining tenure held by De Beers on behalf of the GKJV is valid and sufficient to support Mineral Reserves and plans for mine development. GKJV must take appropriate steps to ensure renewal of the leases in 2023.
- At this time, all permits required for ongoing exploration and the pioneering phase of the project are in force. Permits required for full construction and operation were identified and De Beers is currently in the process for obtaining those permits defined.
- The 2009 Technical Report (AMEC, 2009) and 2013 Technical Report (Mineral Services, 2013), which provided the basis for the Mineral Resource estimations and resources models, are suitable for feasibility project work and were completed to acceptable standards.
- Metallurgical testwork is appropriate for the stage of the project and is adequate to support Mineral Reserve estimation, project feasibility, and economic analysis.
- Estimates of Mineral Reserves conform to industry-standard practices. Mine plans, dilution and economic parameters applied to resource estimates have been prepared to industry standard practices.
- Pit slope stability analysis work has been done to industry standards and conclusions are supported by practices at similar sized operations in the area.
- Mineral reserves support a 3M tonne per year operation with a mine life of 12 years.
- Mine plans use traditional open pit mining utilising proven equipment.
- Process plant design has been adequately defined for cost estimating purposes.
- Mine infrastructure has been adequately designed and estimated in the feasibility study using industry standard practices.
- Sound environmental management plans have been developed for the feasibility study.
- An Environmental Impact Statement (EIS) was prepared and submitted to appropriate regulatory authorities.
- An Environmental Impact Review (EIR) process has been completed by the Mackenzie Valley Environmental Impact Review Board (MVEIRB).
- Progressive reclamation plans are included in the feasibility study.
- Mine closure plans have been developed.
- The project is sufficiently robust for proceeding to project financing to support the ongoing staged development program commencing with the completion of the environmental permitting, early

pioneer works program and detail design phases as precursors for full-scale mine construction and operations.

25.2 Cautions Regarding Forward-Looking Information

This Report contains estimates, projections and conclusions that are forward-looking information within the meaning of applicable securities laws. There can be no assurance that forward-looking information in this Report will prove to be accurate, as actual results and future events could differ materially from those anticipated in such statements or information.

This report contains forward-looking information regarding projected mine production rates and forecasts of resulting cash flows as part of the feasibility study. These estimates are based on assumptions regarding input costs that include but are not limited to labour wages, steel, diesel fuel, operational contracts, and mining and processing equipment, that may be significantly different if a mine were to be built and operated. The kimberlite tonnage and diamond grades are estimate from sampling data and actual tonnages and grades may differ from the estimates. The diamond grades are based on sufficient sampling that is reasonably expected to be representative (as per definition of probable reserves) of the realised grade from actual mining operations. The estimated rough diamond price values may not be realised. Other factors such as: the ability to obtain the necessary permits to construct and operate a mine; significant changes to applicable laws and regulations; to obtain major equipment and/or skilled labour on a timely basis; to achieve the assumed mine production rates at the assumed diamond grade; etc, may cause actual results to differ materially from those presented here.

Words such as “anticipate”, “believe”, “plan”, “expect”, “estimate”, “intend”, “budget”, “scheduled”, “forecast”, “project” and similar expressions are often (but not necessarily always) used to identify forward-looking information.

25.3 Conclusions

The Project is **economically viable**, generating an estimated C\$7,720.8 M in RV (realised value) revenues over a 12-year mine life resulting in a 32.6% IRR (real rate of return) and an estimated \$1,004.8 M NPV (net present value) at 10% excluding sunk costs of \$259.5 M incurred prior to Dec 31, 2013. Including sunk costs of the project yields a 21.9% IRR and \$747.3 M NPV. Total life of mine (LOM) capital costs are estimated at \$1,290.8 M consisting of: \$140.9 M sunk costs (pre-2011); \$118.6 M sunk costs (2011-2013); \$858.5 M initial capital; \$80.1 M working capital; and \$92.7 M sustaining and closure costs. Total LOM pre-tax cash operating costs are estimated at \$2.542.8 M which equates to \$72.51/t processed or \$47.62/ct recovered. Operating costs incurred during the initial ramp up phase are estimated at \$81.9 M.

The Project is **technically credible**, utilising designs and practices that are proven in the Canadian diamond industry. The project design is based on the open pit mining of the 5034, Hearne and Tuzo deposits in a concurrent/sequential fashion (5034 and Hearne mined initially followed by Tuzo). Mine

plans call for the extraction of 315 Mt of waste and 35.1 Mt of mill feed over a 15-year period (including construction/pre-production) utilising industry standard drill/blast equipment, truck/shovel equipment and pit designs that are similar to other open pit diamond mines operating in the area. The kimberlite processed includes the Mineral Reserves as well as an additional 1.2 Mt of dilution that will be processed through the mill. This added tonnage is at zero grade and does not provide any additional revenue, and is comprised of external waste at depth that is included in the pit design and is not classified as an Indicated Resource. Kimberlite will be fed to a 3.0 Mt/a processing plant with three stages of crushing, DMS, and X-ray/grease diamond recovery circuits. Process plant designs and equipment selections are based on experience from other De Beers operations and utilize proven suppliers. Security measures and designs are based on current De Beers' standards and practices.

Supporting infrastructure includes a diesel power plant, gravel airstrip, five-bay truck shop, emulsion plant, 58 million litres of fuel storage capacity, an accommodation/office complex, incinerators, sewage treatment and water treatment. The primary facilities are interconnected by utilidors providing interior access for personnel. Cost estimates are built up from first principles and are benchmarked against relevant operations. Appropriate contingencies have been applied. De Beers operates the Snap Lake Mine in the NWT and the Victor Mine in Ontario and has provided estimates of general and administrative costs, payroll costs, licenses and fees. An Operational Readiness Implementation (ORI) Study has been performed for the Gahcho Kué project. The ORI Study establishes plans to ensure that the mine is effectively staffed for commissioning, ramp-up and operation. The ORI Study included input from assigned DBCI corporate and operations people in defining the organizational structures, operations labour requirements for the future mine, and in developing the schedule of activities the future operations team will need to carry out.

The project is **environmentally sound**, utilising simple and proven management plans. Baseline biophysical information has been collected since 1996. In recent years, there has been a concerted effort to obtain information that will provide an appropriate basis for use in the future monitoring programs to identify potential effects, and to evaluate impact predictions and monitor the efficacy of mitigation. Multiple environmental monitoring and management plans have been prepared to track and mitigate any impact that the project has on the environment. Water management plans are adaptations of plans used successfully at other NWT diamonds mines. At Gahcho Kué, all potentially contaminated water is kept within a controlled management basin formed by natural drainage patterns. Excess storage capacity allowances created by initial lake dewatering activities provide for operational flexibility and contingencies. Normal mine operations incorporate a program of progressive reclamation that minimizes costs and allows timely monitoring of performance. The mined-out 5034 and Hearne pits are used for waste storage during the later years of the mine life providing ample time for completion of the reclamation of the waste storage areas used during the years.

Since the 2010FS, De Beers has prepared an Environmental Impact Statement (EIS) for the project. Based on the EIS the Project has completed an Environmental Impact Review (EIR) process with the Mackenzie Valley Environmental Impact Review Board (MVEIRB). The MVEIRB process was completed

in 2013 and based on Review Panel's recommendation, the Federal Minister approved the project on October 22, 2013, and the project entered into the permitting and licensing phase.

The Mackenzie Valley Land and Water Board (MVLWB) issued a Land Use Permit (LUP) on November 29, 2013 to undertake preliminary (early or pioneer work associated with camp, airstrip, fuel storage, equipment mobilization, etc) in preparation for the development of the Gahcho Kué diamond mine. On November 28, 2013, De Beers submitted an application for the Type A Land Use Permit (LUP) and Type A Water Licence (WL) for the Gahcho Kué diamond mine. The Water License public hearings are scheduled for early May and the expected date for receipt of the LUP and WL to allow full-scale construction is Q3/Q4 of 2014. De Beers has also made an application to Fisheries and Oceans Canada (DFO) for an authorization under the Fisheries Act to undertake the activities that impact fish habitat. An application will also be submitted to Navigation Protection Act for authorization of dykes and dams. These permits/authorizations are expected to be in place by Q3/Q4 of 2014 to allow the mine to begin full-scale construction.

The project provides socioeconomic benefits. A Socio Economic Agreement (SEA) for the project was signed with the Government of the Northwest Territories (GNWT) on June 28, 2013. The SEA establishes hiring priorities and employment incentives for the project, training and employment objectives, business procurement objectives and it outlines how De Beers and the GNWT will work together to ensure the health and cultural well-being of NWT Residents. The mine will create close to 1,000 jobs during the two-year construction phase and some 450 permanent jobs during the 12-year operational phase. Additional employment will be created by the multitude of service providers to the project. Territorial taxes, federal taxes, and royalties are estimated to be approximately \$1,500 M during the life of the operation. In addition, property and payroll taxes will add significant tax revenues to the local municipality. Impact and Benefit Agreements (IBAs) are in place or under final stages of negotiations for the First nation groups in the vicinity.

Risks for the project are identified and considered reasonable. The greatest economic risk/opportunity is related to the resource (estimated diamond values) and market diamond prices. Several years ago, the rough diamond diamond/prices/sales experienced unprecedented volatility because of the world economic crisis. Diamond price estimates are provided by the JV partners. The project JV partners are forecasting a 1.5% real growth in diamond prices.

The remoteness of the Gahcho Kué mine also leads to significant risks to the project cost schedule, and ongoing operations. Other key risks include:

- Permitting – The uncertainty of actual permitting conditions and issuance dates could have a major impact on the capital phase schedule and cost as well as long term operational cost impacts.
- Ice Road – There could be extensive delivery delays if a heavy or large piece of equipment or material does not make the two-month window, as the delivery will be a year later. In addition,

milder winters or inclement weather can affect the quantity, size and pricing can be brought up on the ice road in any given year.

- Extreme Winter Conditions – Can have a more severe impact than expected on construction/operations workers’ productivity.
- Availability of competent personnel. There could be productivity reduction leading to delays and cost overruns if the project is not able to attract qualified personnel. This risk increases as other projects compete for resources in the same region at the time of the project.

In many the cases, mitigation actions to minimize the likelihood have been identified and will be implemented. In other cases, the mitigation actions (prevention and/or attenuation) need to be evaluated or re-assessed to ensure that the desired risk level will be obtained after implementation.

SECTION 26 RECOMMENDATIONS

Based on the conclusions derived in this Gahcho Kué Project 2014 Feasibility Study NI 43-101 Technical Report, the Authors' recommendation is for the project owners to proceed to the full-scale project construction phase, with final release of project funding subject to receipt of the environmental permits.

SECTION 27 REFERENCES

- 2013 Update of the Mineral Resource Estimate for the Tuzo Kimberlite, Gahcho Kué Project, Northwest Territories, Canada NI 43-101 Technical Report, July 2013. Available on SEDAR
- (Non-public Report: Re-Price & Modelling of the Average Price of Diamonds from the Gahcho Kué Diamond Project – February 2014)
- Gahcho Kué Project Definitive Feasibility Study NI 43-101 Technical Report, Dec. 2010. Available on SEDAR
- AMEC Gahcho Kué Kimberlite Project NI 43-101 Technical Report, 2009. Available on SEDAR
- BHP Billiton Diamonds Inc. 2008. Ekati Diamond Mine Watershed Adaptive Management Plan. Prepared by Rescan Environmental Services Ltd., Yellowknife, NWT and Vancouver, B.C.
- CFIA (Canadian Food Inspection Agency). 2009. Canadian Food Inspection Agency Fish Products Standards and Methods Manual: Appendix 3 Canadian Guidelines for Chemical Contaminants and Toxins in Fish and Fish Products. Ottawa, ON: Canadian Food Inspection Agency.
- Chapman, P.M. and J. Anderson. 2005. A decision-making framework for sediment contamination. *Integrated Environmental Assessment and Management*, 1 (3): 163-173.
- De Beers (De Beers Canada Inc.). 2010. Environmental Impact Statement for the Gahcho Kué Project. Volumes 1, 2, 3a, 3b, 4, 5, 6a, 6b, 7 and Annexes A through N. Submitted to Mackenzie Valley Environmental Impact Review Board, Yellowknife, NWT. December 2010.
- De Beers. 2011a. Environmental Impact Statement for the Gahcho Kué Project. Volume 3a Revision 2, Volume 3b Revision 2, Volume 4 Revision 2, and Volume 5 Revision 2. Submitted to Mackenzie Valley Environmental Impact Review Board in response to the Environmental Impact Statement Conformity Review. Yellowknife, NWT. September 2011.
- De Beers. 2011b. Adaptive Management Plan – Snap Lake Mine. Submitted to the Mackenzie Valley Land and Water Board, Yellowknife, NWT. May 2011.
- De Beers. 2012a. Environmental Monitoring and Management Framework. Gahcho Kué Project. Submitted to the Mackenzie Valley Environmental Impact Review Board, Yellowknife, NWT. May 2012.
- De Beers. 2012b. Environmental Impact Statement Supplemental Information Submission for the Gahcho Kué Project. Submitted to the Mackenzie Valley Environmental Impact Review Board, Yellowknife, NWT. April 2012.
- De Beers. 2013a. Updated Project Description for the Gahcho Kué Project. Submitted to the Mackenzie Valley Land and Water Board, Yellowknife, NWT. November 2013.

De Beers. 2013b. Gahcho Kué Project Community Engagement Update – November 21, 2012 to September 24, 2013. De Beers Canada Inc. Submitted to the Mackenzie Valley Environmental Impact Review Board, Yellowknife, NWT. November 2012.

De Beers. 2013c. Conceptual Aquatics Effects Monitoring Program Design Plan. Gahcho Kué Mine. Submitted to the Mackenzie Valley Land and Water Board, Yellowknife, NWT. November 2013.

De Beers. 2013d. Wildlife Effects Monitoring Program. Gahcho Kué Project. Submitted to the Mackenzie Valley Land and Water Board, Yellowknife, NWT. May 2013.

De Beers. 2013e. Vegetation and Soils Monitoring Program. Gahcho Kué Project. Submitted to the Mackenzie Valley Land and Water Board, Yellowknife, NWT. May 2013.

De Beers. 2013f. Air Quality Emissions Monitoring and Management Plan. Gahcho Kué Project. Submitted to the Mackenzie Valley Land and Water Board, Yellowknife, NWT. May 2013.

De Beers. 2013g. Groundwater Monitoring Program. Gahcho Kué Mine. Submitted to the Mackenzie Valley Land and Water Board, Yellowknife, NWT. November 2013.

De Beers. 2013h. Geochemical Characterization Plan. Gahcho Kué Mine. Submitted to the Mackenzie Valley Land and Water Board, Yellowknife, NWT. November 2013.

De Beers. 2013i. Conceptual Closure and Reclamation Plan. Gahcho Kué Mine. Submitted to the Mackenzie Valley Land and Water Board, Yellowknife, NWT. November 2013.

De Beers. 2013j. Explosives Management Plan. Gahcho Kué Mine. Submitted to the Mackenzie Valley Land and Water Board, Yellowknife, NWT. November 2013.

De Beers. 2013k. Wildlife and Wildlife Habitat Protection Plan. Gahcho Kué Project. Submitted to the Mackenzie Valley Land and Water Board, Yellowknife, NWT. May 2013.

De Beers. 2013l. Emergency Response Plan. Gahcho Kué Mine. Submitted to the Mackenzie Valley Land and Water Board, Yellowknife, NWT. November 2013.

De Beers. 2013m. Spill Contingency Plan. Gahcho Kué Mine. Submitted to the Mackenzie Valley Land and Water Board, Yellowknife, NWT. November 2013.

De Beers. 2013n. Waste Management Framework. Gahcho Kué Mine. Submitted to the Mackenzie Valley Land and Water Board, Yellowknife, NWT. September 2013.

De Beers. 2013o. Processed Kimberlite and Mine Rock Plan. Gahcho Kué Mine. Submitted to the Mackenzie Valley Land and Water Board, Yellowknife, NWT. November 2013.

De Beers. 2013p. Water Management Plan. Gahcho Kué Mine. Submitted to the Mackenzie Valley Land and Water Board, Yellowknife, NWT. November 2013.

De Beers. 2013q. Sediment and Erosion Management Plan. Gahcho Kué Mine. Submitted to the Mackenzie Valley Land and Water Board, Yellowknife, NWT. November 2013.

De Beers. 2013r. Incinerator Management Plan. Gahcho Kué Project. Submitted to the Mackenzie Valley Land and Water Board, Yellowknife, NWT. May 2013.

- De Beers. 2013s. Non-hazardous Solid Waste Management Plan. Gahcho Kué Mine. Submitted to the Mackenzie Valley Land and Water Board, Yellowknife, NWT. November 2013.
- De Beers. 2013t. Hazardous Materials and Waste Management Plan. Gahcho Kué Mine. Submitted to the Mackenzie Valley Land and Water Board, Yellowknife, NWT. November 2013.
- De Beers. 2013u. Landfarm Management Plan. Gahcho Kué Project. Submitted to the Mackenzie Valley Land and Water Board, Yellowknife, NWT. May 2013.
- Diavik (Diavik Diamond Mines Inc.). 2007. Diavik Diamond Mine Adaptive Management Plan for Aquatic Effects. Version 0 - August 2007. Submitted to Wek'èezhii Land and Water Board. 42 pp.
- EC and MOE (Environment Canada and Ontario Ministry of Environment). 2008. Canada-Ontario Decision-Making Framework for Assessment of Great Lakes Contaminated Sediment. Prepared by Peter Chapman (Golder Associates Ltd.) with the COA Sediment Task Group. 75 pp.
- Greig, L., D. Marmorek and C. Murray. 2008. Guide for Preparation of Adaptive Management Plans. Prepared by ESSA Technologies Ltd., Richmond Hill, ON for Fisheries and Oceans Canada, Western Arctic Area, Central and Arctic Region, Yellowknife [NT] 8 pp.
- Government of Northwest Territories (GNWT). 2013. Communities and Diamonds: 2012 Annual Report. Available from:
http://www.google.ca/url?sa=t&rct=j&q=&esrc=s&frm=1&source=web&cd=1&cad=rja&ved=0CDsQFjAA&url=http%3A%2F%2Fwww.iti.gov.nt.ca%2Fpublications%2F2013%2Fdiamonds%2F2012_Communities_and_Diamonds.pdf&ei=OMBvUuTsGLHtiQKV_oG4CQ&usg=AFQjCNH83p9H2iyaaHBpG0zoUan7vfhZYg&sig2=IUgNCHSgcWBSNeNpwD8TmQ
- Mackenzie Valley Environmental Impact Review Board (MVEIRB). 2013. Gahcho Kué Diamond Mine – EIR0607-001 (2006) Public Hearing Document List: Community Engagement Update Report Part 1 to 4. Available from
http://www.reviewboard.ca/registry/project_detail.php?project_id=37&doc_stage=10
- McLoughlin, P.D., F. Messier, R.L. Case, R.J. Gau, R. Mulders and D. Cluff, 1999. The Spatial Organization and Habitat Selection Patterns of Barren ground Grizzly Bears (*Ursus arctos*) in the Northwest Territories and Nunavut: Final Report to the West Kitikmeot/Slave Study Society.
- McLoughlin, P.D. and F. Messier. 2001. The Demography of Barren-ground Grizzly Bears (*Ursus arctos*) in Nunavut and the Northwest Territories. Prepared for the Department of Resources, Wildlife, and Economic Development, Government of the Northwest Territories, Yellowknife, N.W.T.
- Statistics Canada. 2013a. Northwest Territories (Code 61) (table). National Household Survey (NHS) Profile. 2011 National Household Survey. Statistics Canada Catalogue no. 99-004-XWE. Ottawa. Released September 11, 2013. <http://www12.statcan.gc.ca/nhs-enm/2011/dp-pd/prof/index.cfm?Lang=E> (accessed October 29, 2013).
- Statistics Canada. 2013b. Yellowknife, CY, Northwest Territories (Code 6106023) (table). National Household Survey (NHS) Profile. 2011 National Household Survey. Statistics Canada Catalogue no. 99-004-XWE. Ottawa. Released September 11, 2013. <http://www12.statcan.gc.ca/nhs->

[enm/2011/dp-pd/prof/index.cfm?Lang=E](http://www12.statcan.gc.ca/nhs-enm/2011/dp-pd/prof/index.cfm?Lang=E)

(accessed October 30, 2013).

Statistics Canada. 2013c. Hay River Dene 1, IRI, Northwest Territories (Code 6104017) (table). National Household Survey (NHS) Profile. 2011 National Household Survey. Statistics Canada Catalogue no. 99-004-XWE. Ottawa. Released September 11, 2013. <http://www12.statcan.gc.ca/nhs-enm/2011/dp-pd/prof/index.cfm?Lang=E> (accessed October 30, 2013).

Statistics Canada. 2013d. Behchokò, CG, Northwest Territories (Code 6103031) (table). National Household Survey (NHS) Profile. 2011 National Household Survey. Statistics Canada Catalogue no. 99-004-XWE. Ottawa. Released September 11, 2013. <http://www12.statcan.gc.ca/nhs-enm/2011/dp-pd/prof/index.cfm?Lang=E> (accessed October 30, 2013).

Statistics Canada. 2013e. Lutselk'e, SET, Northwest Territories (Code 6105020) (table). National Household Survey (NHS) Profile. 2011 National Household Survey. Statistics Canada Catalogue no. 99-004-XWE. Ottawa. Released September 11, 2013. <http://www12.statcan.gc.ca/nhs-enm/2011/dp-pd/prof/index.cfm?Lang=E> (accessed October 30, 2013).

Statistics Canada. 2013f. Table379-0028 - Gross domestic product (GDP) at basic prices, by North American Industry Classification System (NAICS), provinces and territories, annual (percentage share), CANSIM (database). (accessed: 2013-10-30) Available from: <http://www5.statcan.gc.ca/cansim/a46>

Statistics Canada, 2011. National Household Survey Statistics Canada Catalogue no. 99-012-X2011039.,

Statistics Canada. 2007. Northwest Territories (Code61) (table). 2006 Community Profiles. 2006 Census. Statistics Canada Catalogue no. 92-591-XWE. Ottawa. Released March 13, 2007. <http://www12.statcan.ca/census-recensement/2006/dp-pd/prof/92-591/index.cfm?Lang=E> (accessed November 1, 2013).

Statistics Canada, 2006a. Census of Population, Statistics Canada catalogue no. 97-560-XCB2006028 (Canada, Code01)

Statistics Canada, 2006b. Census of Population, Statistics Canada catalogue no. 97-563-XCB2006062 (Northwest Territories / Territories du Nord-Ouest, Code61)

Statistics Canada. 2002. Profile of NWT, Census of Canada 2001, Archived. Available from: <http://www12.statcan.gc.ca/english/census01/products/standard/prprofile/prprofile.cfm?G=61>

Suter, G.W. 1993. Ecological Risk Assessment. Chelsea, MI; Lewis Publishers.

Suter, G.W., R.A. Efrogmson, B.E. Sample, and D.S. Jones. 2000. Ecological Risk Assessment for Contaminated Sites. Lewis Publishers, New York, NY, USA.

WLWB (Wek'èezhii Land and Water Board). 2010. Guidelines for Adaptive Management – a Response Framework for Aquatic Effects Monitoring (Draft). 49 pp.